



PLASTICKÁ CHIRURGIE

CHIRURGICKÉ NÁSTROJE





Jarit nabízí více než 30 let zkušeností na poli chirurgických nástrojů. Díky spolupráci s předními světovými výrobci vznikly unikátní chirurgické nástroje spojující v sobě americkou vynalézavost s precizností vlastní německým výrobcům.

Nástroje Jarit jsou vyrobeny z nejvyšší chirurgické oceli a splňují všechny požadavky kladené chirurgem na ergonomii a vyváženost.

Naším cílem je kompromis mezi kvalitou a cenou tak abychom uspokojili nároky kladené nemocnicemi.

Na vybrané chirurgické nástroje je poskytována tříletá záruka.

Volit můžete z široké nabídky nástrojů od běžně používaných po úzce specializované. Nástroje jsou rozděleny do několika katalogů, podle oborů.

U chirurgických nůžek, jehelců a pinzet máte na výběr až ze tří možností dle Vašich potřeb a nároků. Tyto nástroje jsou odlišeny pomocí různě barevných rukojetí.



Záruční podmínky

Záruka na všechny nástroje Jarit se vztahuje na veškeré defekty materiálu a provedení. Jarit opraví, nebo vymění zdarma veškeré nástroje, které vykazují tyto defekty a byly užívány v souladu s doporučeními výrobce.

Všechny nástroje CARB - BITE a CARB - EDGE mají navíc záruku 3 roky. Pokud se během této doby vyskytnou jakékoli problémy, CARB - EDGE nůžky budou zdarma nabroušeny a CARB - BITE jehelce budou vyměněny.

Všechny JARIT SUPERCAT nůžky mají navíc záruku jeden rok. Pokud bude potřeba provést naostření bude toto v záruční lhůtě provedeno zdarma. Po uplynutí záruční lhůty bude nabroušení provedeno za poplatek.

JOSEPH Nasal Knives,
6" (15.2cm), double-edged, sharp

- 410-100** Straight, 4mm x 23mm blade
- 410-101** Straight, 6mm x 23mm blade
- 410-105** Curved, 4mm x 23mm blade
- 410-106** Curved, 6mm x 23mm blade

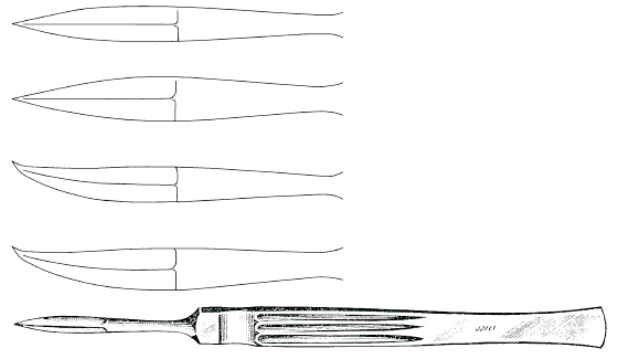

JOSEPH Nasal Knives,
6" (15.2cm), double-edged, blunt

- 410-110** Straight, 4mm x 23mm blade
- 410-111** Straight, 6mm x 23mm blade
- 410-115** Curved, 4mm x 23mm blade
- 410-116** Curved, 6mm x 23mm blade

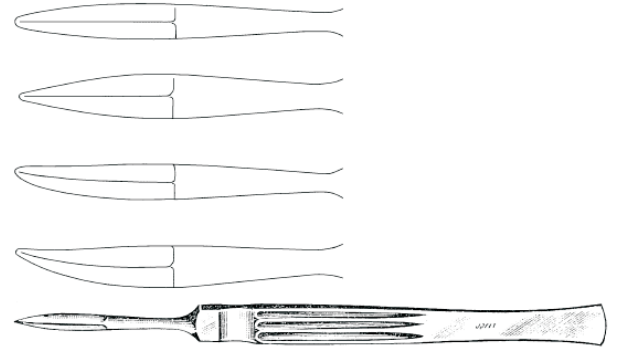

- 410-120** **JOSEPH** Button End Knife,
6" (15.2cm), straight, 29mm blade

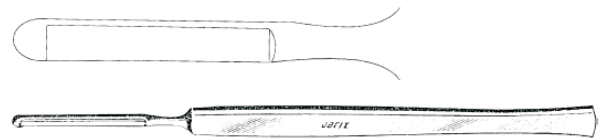

- 410-121** **JOSEPH** Button End Knife,
6½" (16.5cm), angled, 9mm blade

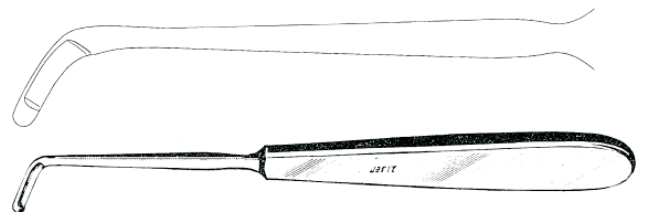

410-123 **CONVERSE** Button End Bistoury,
6½" (15.5cm), curved, 29mm blade

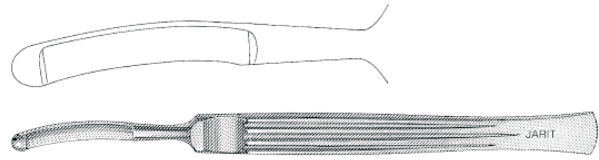

410-125 **MALTZ** Button End Knife,
6½" (16.5cm), 9mm blade

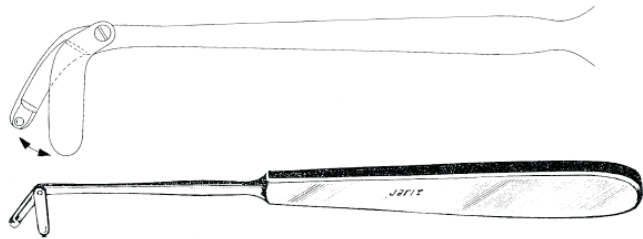

410-128 **COTTLE** Nasal Knife,
5½" (14cm), 4mm blade

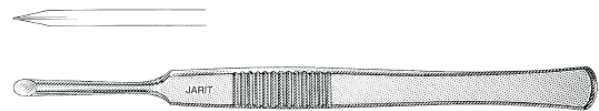

410-130 **COTTLE** Double Edged Knife,
5¾" (14.6cm), straight, 6mm x 24mm blade



350-360 O'CONNOR Hook,
5" (12.7cm)



GUTHRIE Hooks,
4 1/4" (12.1cm)
350-370 Small: 1.5mm wide
350-371 Large: 2.5mm wide

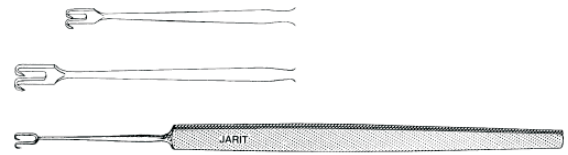

KLEINERT-KUTZ Skin Hooks,
6" (15.2cm)
410-135 Small: 3mm
410-136 Medium: 5mm
410-137 Large: 7mm

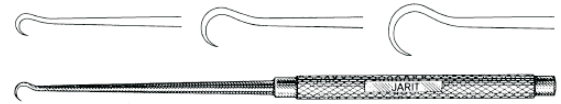

410-140 JARIT Skin Hook,
5" (12.7cm), fine



COTTLE Skin Hooks,
5 1/4" (13.3cm)
410-145 Shallow curve, small
410-146 Deep curve, small
410-147 Deep curve, large

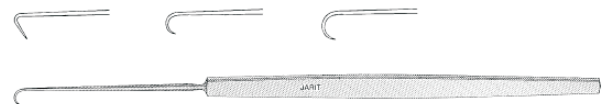

410-150 JOSEPH Skin Hook,
6¼" (15.9cm), single prong



JOSEPH Skin Hooks,
6¼" (15.9cm), double prong

410-151 2mm wide
410-152 5mm wide
410-153 7mm wide
410-154 10mm wide

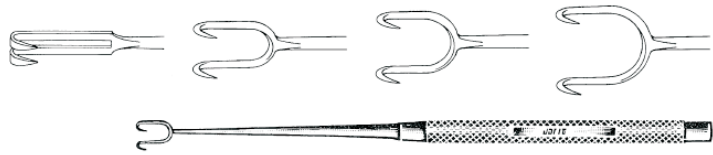

410-157 COTTLE-JOSEPH Double Hook,
5¾" (13.7cm), double prong, 12mm wide

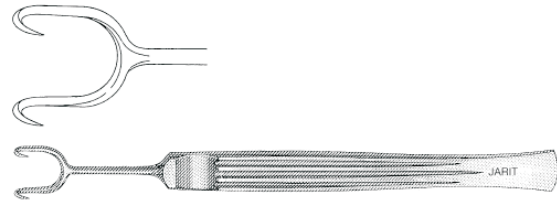

410-160 KILNER Skin Hook,
5" (12.7cm)



410-161 KILNER Skin Hook,
6" (15.2cm), detachable blade



410-163 GOLDMAN Single Hook,
5¾" (13.7cm), right angled



CONVERSE Skin Hooks,
7" (17.8cm)

- 410-165 Small: 2.5mm
- 410-166 Large: 4mm



410-167 **JOHNSON** Skin Hook,
6½" (16.5cm)

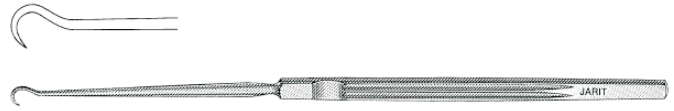

410-170 **GILLIES** Skin Hook,
7½" (19.1cm)



410-180 **COTTLE** Single Prong Tenaculum,
6½" (16.5cm)

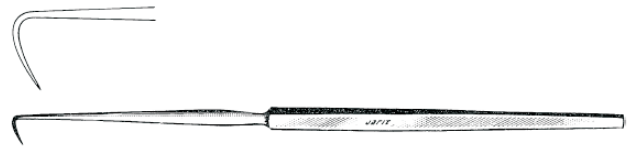

410-182 **JARIT** Palate Hook,
8" (20.3cm)



410-183 **SURACI** Zygoma Hook-Elevator,
9" (22.9cm)

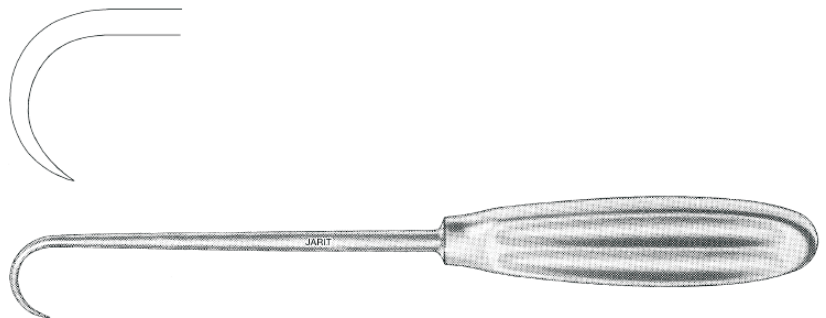

LAHEY Retractors,
4 1/4" (12.1cm), delicate

- 410-185 1-prong
- 410-186 2-prongs
- 410-187 3-prongs

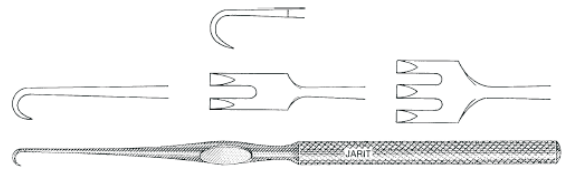

GOLDMAN Knife Guides and Retractors,
6 1/4" (17.5cm), double-ended,
3mm knife guide and 10mm retractor

- 410-193 Left angled knife guide
- 410-194 Right angled knife guide



- 410-195 **COTTLE** Knife Guide and Retractor,
6 1/4" (17.5cm), double-ended,
3.5mm knife guide and 10mm retractor

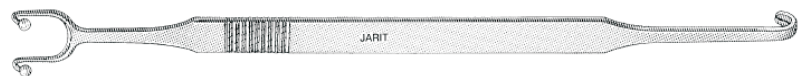

- 410-196 **NEIVERT** Knife Guide and Retractor,
6 3/4" (17.2cm), double-ended,
4mm knife guide and 15mm retractor



COTTLE Retractors,
5½" (14cm), 11mm wide

410-197 Right prong sharp

410-198 Left prong sharp

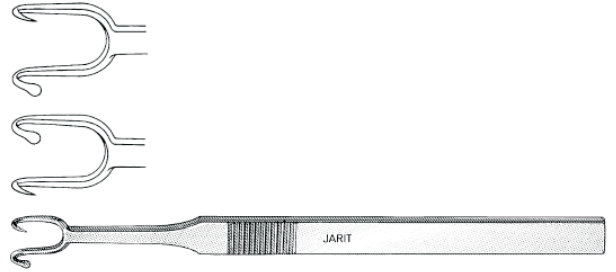

FOMON Retractors,
6¼" (15.9cm)

410-199 1-prong, ball end

410-200 2-prong, ball ends, 12mm wide

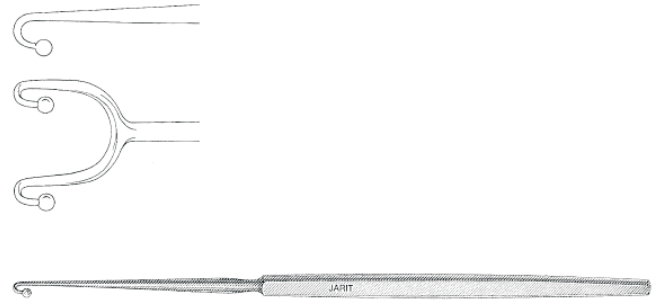

410-201 **COTTLE** Retractor,
5¾" (14.5cm), 2-prong, sharp,
11mm wide

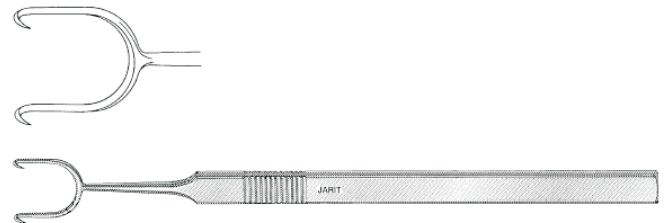

410-202 **COTTLE** Retractor,
6¾" (17.1cm), 2-prong, ball ends,
12mm wide

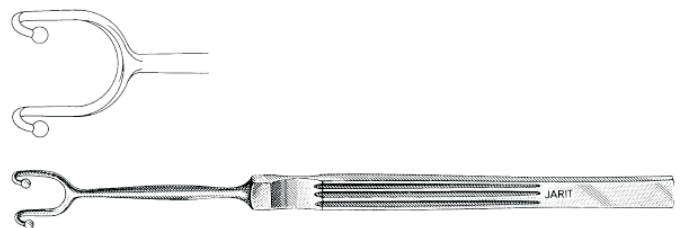

410-203 **COTTLE** Retractor,
5¼" (13.3cm), 4-prong, blunt,
10mm wide

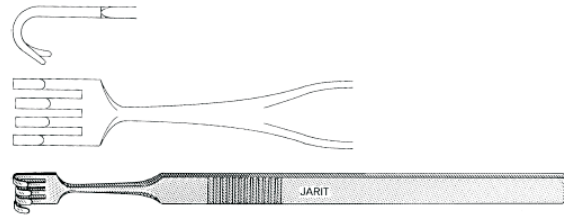

410-205 **CONVERSE** Alar Retractor,
4½" (11.4cm), double-ended,
14mm wide

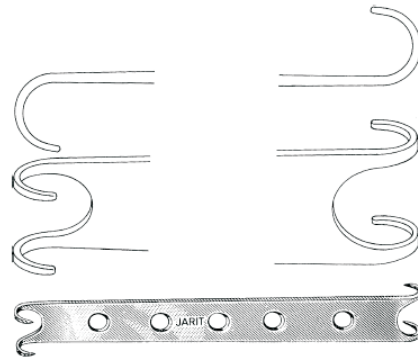

410-207 **COTTLE** Alar Retractor,
6¼" (15.9cm), 14mm wide

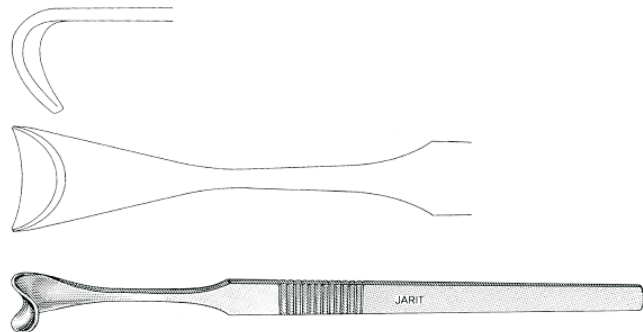

AUFRICHT Nasal Retractors,
7¼" (18.4cm)

410-210 10mm x 45mm blade

410-211 11mm x 60mm blade

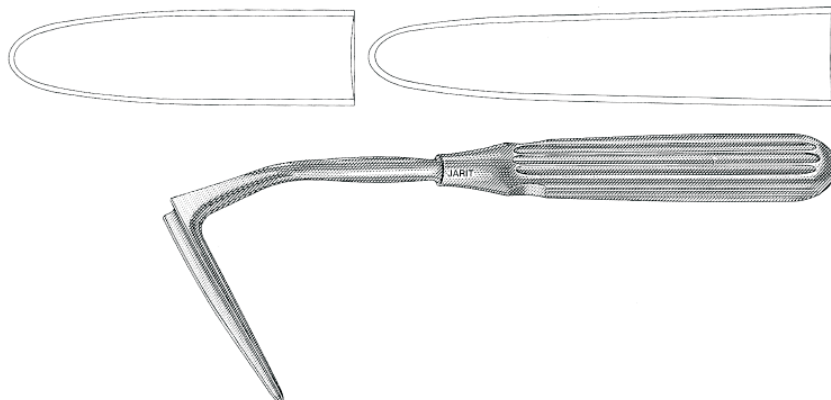

410-215 MALINIAC Nasal Retractor,
4" (10.2cm), 9mm x 45mm blade

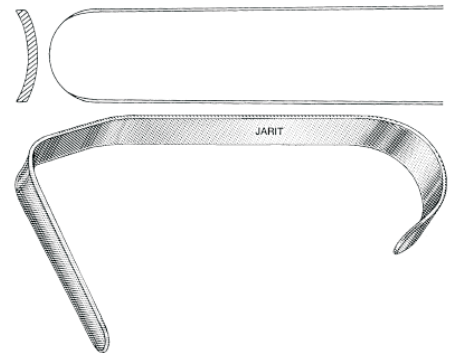

410-218 CONVERSE Nasal Retractor,
4½" (11.4cm), 11mm x 44mm blade



SENN Retractors,
6¼" (15.9cm), double-ended, 8mm wide,
solid blade ¾" x ¼" (19mm x 6.3mm)

190-110 3 sharp prongs
190-112 3 blunt prongs

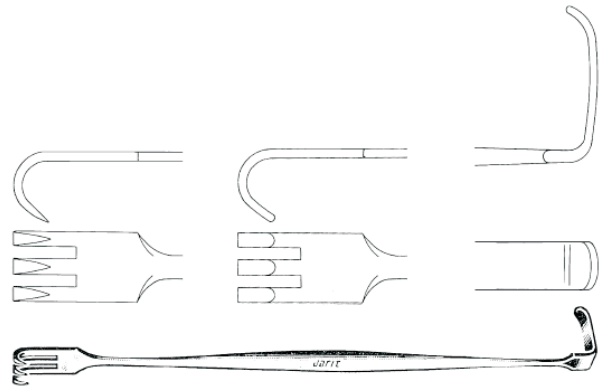

MATHIEU Retractors,
6¼" (15.9cm), double-ended, 8mm wide,
solid blade ¾" x ¼" (19mm x 6.3mm)

190-115 3 sharp prongs
190-116 3 blunt prongs

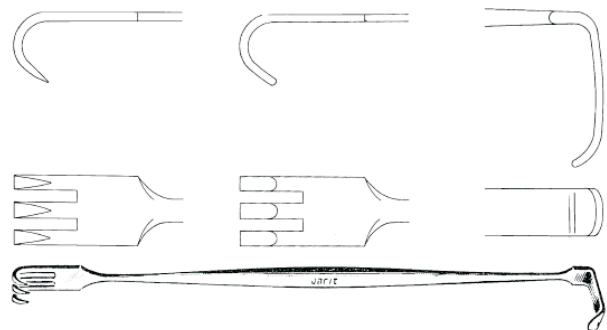

190-118 ROLLET Retractor,
5" (12.7cm), 4 sharp prongs, 6mm wide



190-120 KNAPP Retractor,
5" (12.7cm), 4 blunt prongs, 6mm wide



190-129 MEYERDING Skin Hook and Retractor,
6 1/4" (15.9cm), solid blade 5/8" x 3/8" wide (16mm x 5mm)

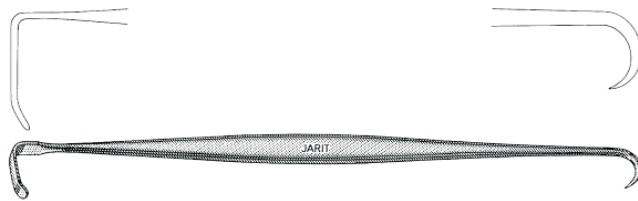

MEYERDING Finger Retractors,
7" (17.8cm)

- 190-130** Style 1, 1/16" x 3/32" wide (21mm x 7.1mm)
- 190-131** Style 2, 5/8" x 3/16" wide (16mm x 5mm)
- 190-132** Style 3, 1/4" x 5/32" wide (6.3mm x 4mm)
- 190-133** Style 4, 3/8" x 1/8" wide (10mm x 3.2mm)
- 190-134** Style 5, 3/16" x 5/32" wide (8mm x 4mm)
- 190-135** Style 6, 1/4" x 5/16" wide (6.3mm x 8mm)

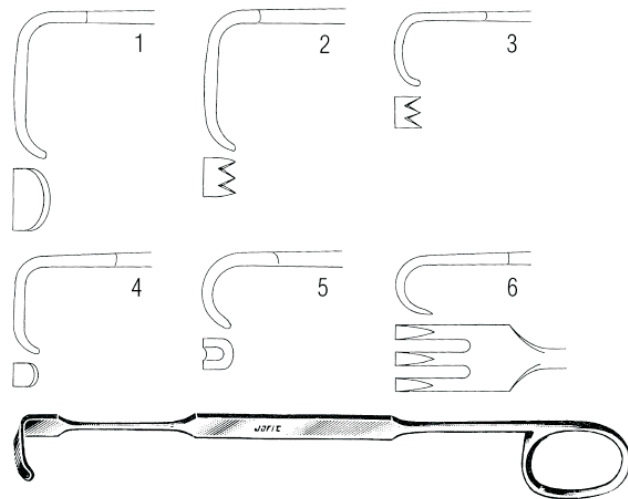

JARIT RETRACTORS

FINGER Rake Retractors,
6½" (16.5cm)

- 190-150** 1 prong, sharp
- 190-151** 2 prongs, sharp, 5mm wide
- 190-152** 3 prongs, sharp, 8mm wide
- 190-153** 4 prongs, sharp, 12mm wide
- 190-154** 1 prong, blunt
- 190-155** 2 prongs, blunt, 5mm wide
- 190-156** 3 prongs, blunt, 8mm wide
- 190-157** 4 prongs, blunt, 12mm wide

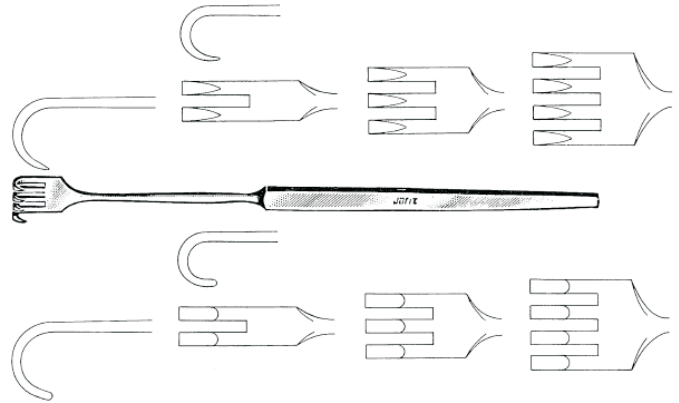

- 410-220** **RAGNELL Retractor,**
6" (15.2cm), double-ended,
2.5mm x 9mm and 5mm x 15mm blades

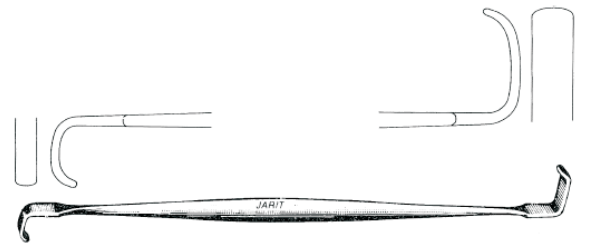

MILLER Retractors,
5¼" (13.3cm), 9 prongs, 15mm wide

- 410-225** Blunt
- 410-226** Sharp

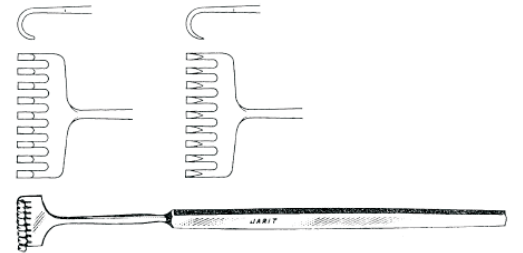

- 410-230** **DAVIS Retractor,**
5½" (14cm), double-ended,
5mm x 16mm and 8mm x 21mm blades

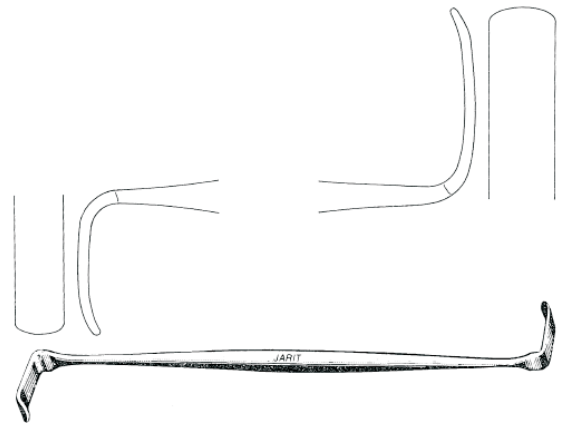

CONVERSE Blade Retractors,
3¼" (8.3cm)

- 410-235** Size 1: 9mm x 18mm blade
- 410-236** Size 2: 13mm x 28mm blade
- 410-237** Size 3: 13mm x 41mm blade
- 410-238** Size 4: 13mm x 55mm blade

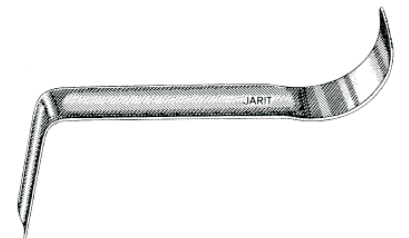

205-100 ALM Retractor,
2¾" (7cm), 2" (5cm) spread

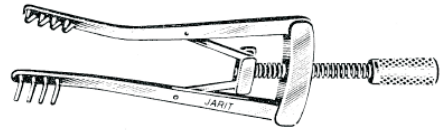

205-105 ALM Retractor,
4" (10.2cm), 2½" (6.4cm) spread

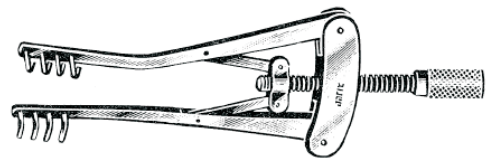

JARIT Cross Action Retractors,
4" (10.2cm), 1" (2.5cm) spread

205-110 Sharp prongs

205-111 Blunt prongs

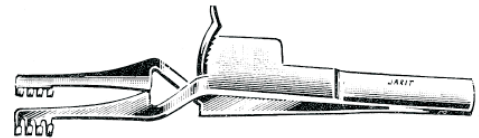

GELPI Retractors,
pediatric sizes

205-123 3½" (8.9cm)

205-124 4½" (11.4cm)

205-125 5½" (14cm)

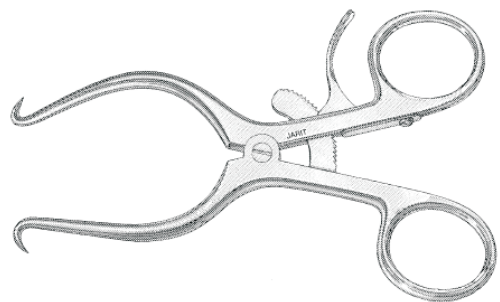

JARIT SELF-RETAINING RETRACTORS

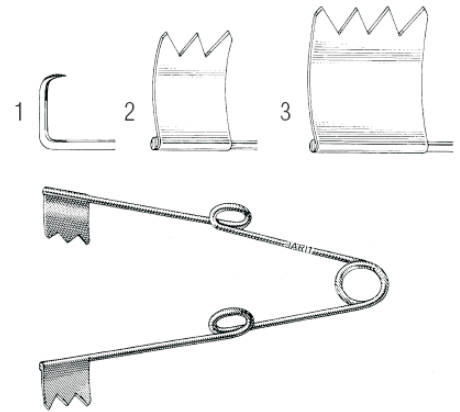

JARIT Spring Wire Retractors

- 205-136 Style 1: 3" (7.5cm)
- 205-137 Style 2: 3½" (9cm)
- 205-138 Style 3: 4½" (11.4cm)

WEITLANER Retractors

- 205-140 4½" (11.4cm), 2 x 3 sharp prongs, 15mm deep
- 205-141 4½" (11.4cm), 2 x 3 blunt prongs, 15mm deep
- 205-150 5½" (14cm), 3 x 4 sharp prongs, 17mm deep
- 205-151 5½" (14cm), 3 x 4 blunt prongs, 17mm deep
- 205-155 6½" (16.5cm), 3 x 4 sharp prongs, 18mm deep
- 205-156 6½" (16.5cm), 3 x 4 blunt prongs, 18mm deep

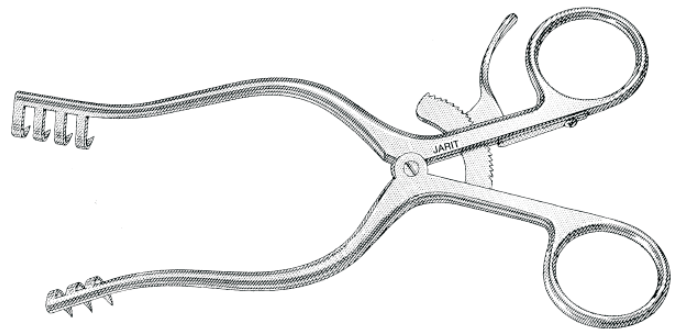

WEITLANER Retractors,
hinged blades

- 205-175 5½" (14cm), 3 x 4 sharp prongs, 18mm deep
- 205-176 5½" (14cm), 3 x 4 blunt prongs, 18mm deep
- 205-180 6½" (15.9cm), 3 x 4 sharp prongs, 18mm deep
- 205-181 6½" (15.9cm), 3 x 4 blunt prongs, 18mm deep

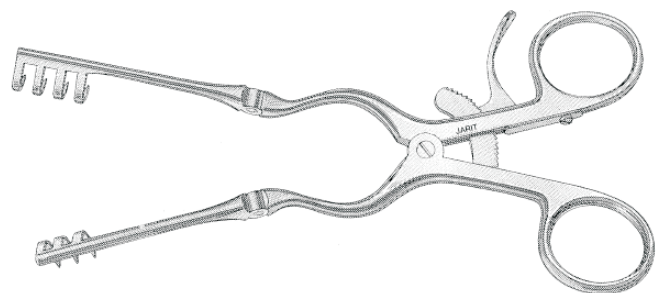

DESCHAMPS Ligature Carriers

- 125-150 8" (20.3cm), sharp, left
- 125-152 8" (20.3cm), sharp, right
- 125-154 8" (20.3cm), blunt, left
- 125-155 8" (20.3cm), blunt, right

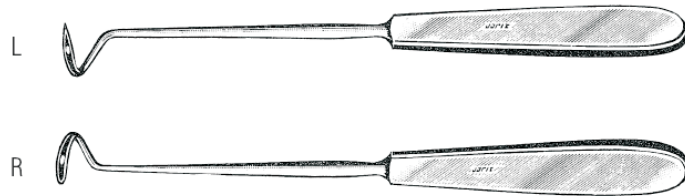

- 410-265 **DINGMAN** Wire Passer,
6¾" (17cm), curved



- 450-090 **DINGMAN** Mouth Gag,
complete with 3 tongue blades

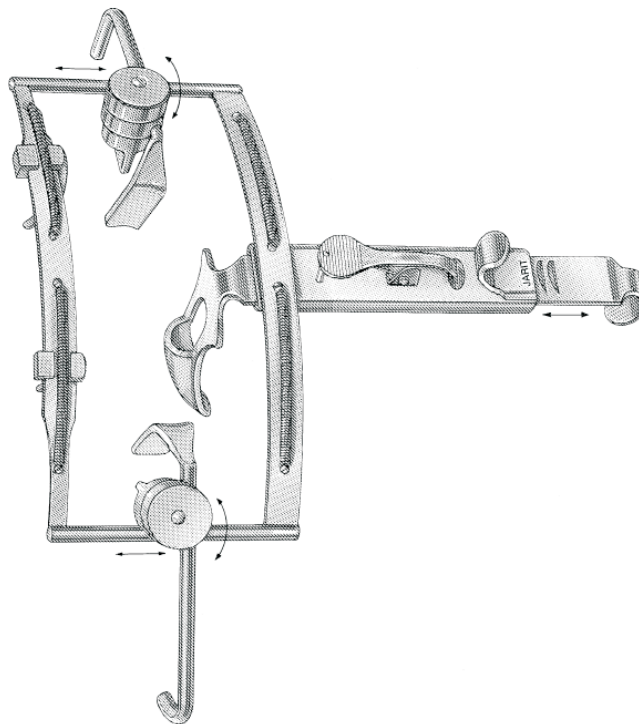

ANDERSON-NEIVERT Osteotomes,
with guard, 8" (20.3cm), 4mm wide

- 410-275 Curved left
- 410-276 Curved right

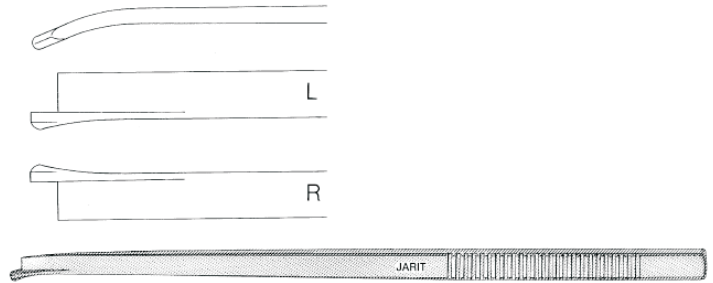

CONVERSE Osteotomes,
7" (17.8cm)

- 410-280 2mm wide
- 410-281 4mm wide
- 410-282 6mm wide
- 410-283 8mm wide
- 410-284 10mm wide
- 410-286 12mm wide
- 410-288 14mm wide

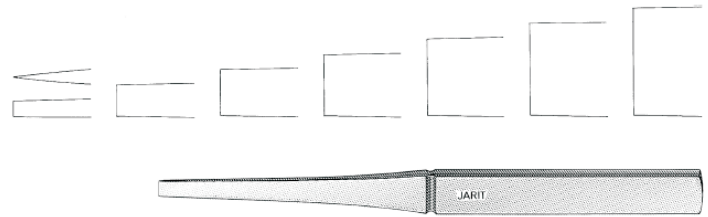

COTTLE Chisels,
7¼" (18.4cm),
depth markings at 2, 3, 4 and 5 centimeters

- 410-290 4mm wide
- 410-291 7mm wide
- 410-292 9mm wide
- 410-293 12mm wide

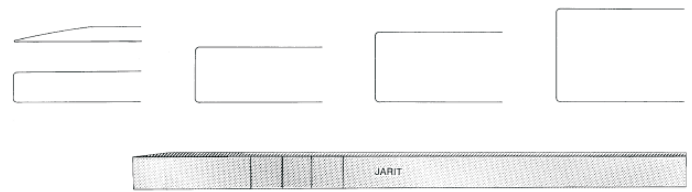

- 410-295 **COTTLE** Chisel,
7¼" (18.4cm), curved, 6mm wide,
depth markings at 3.5, 4.5, 5.5 and 6.5 centimeters



JARIT CHISELS AND OSTEOTOMES

410-296 **FOMON** Chisel,
with guard, 6" (15.2cm),
straight, 7mm wide

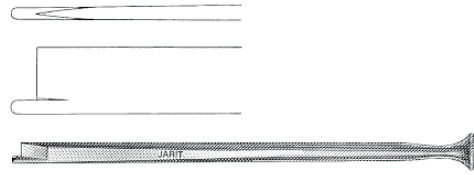

CONVERSE Chisels,
with guard, 7½" (19cm),
6mm wide

410-297 Curved right
410-298 Curved left

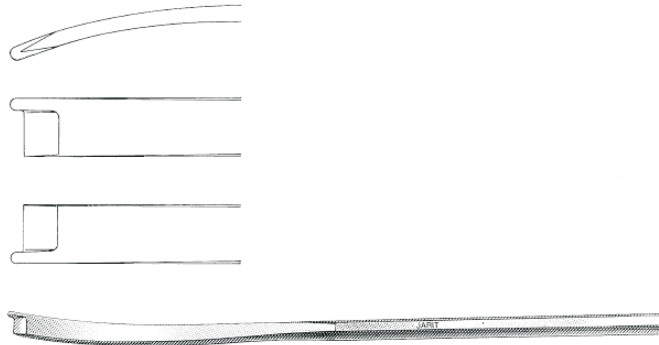

SILVER Osteotomes,
with guard, 7" (17.8cm),
4mm wide

410-300 Straight
410-301 Curved right
410-302 Curved left

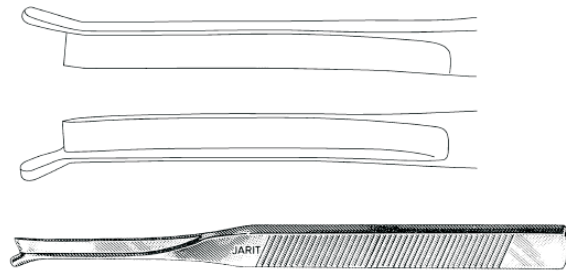

CINELLI Osteotomes,
double-guarded, 6½" (16.5cm)

410-305 10mm wide, straight
410-306 12mm wide, straight
410-307 14mm wide, straight
410-308 16mm wide, straight
410-310 10mm wide, curved

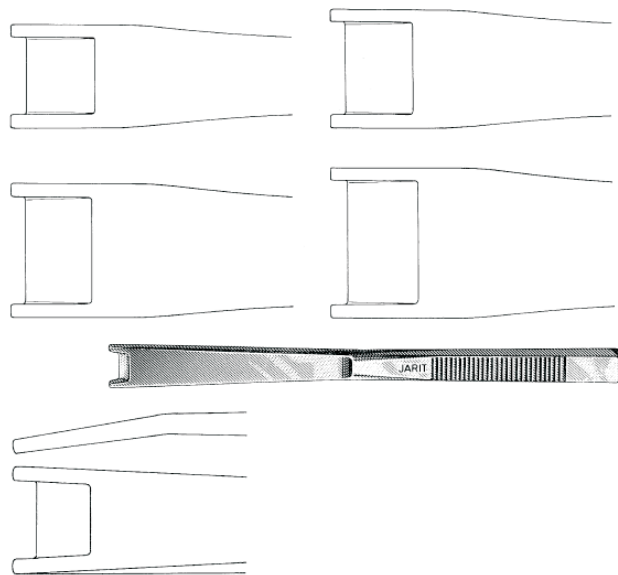

410-312 **PARKES** Osteotome, with guard, 7" (17.8cm), straight, 4mm wide

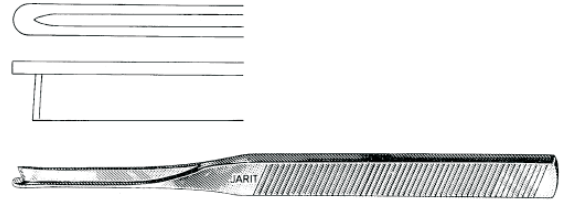

410-313 **PARKES** Hump Gouge, double-guarded, 7" (17.8cm), straight, 6mm wide

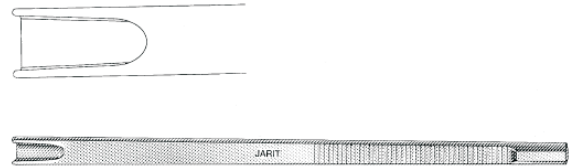

410-314 **NEIVERT** Osteotome, with guard, 8" (20.3cm), straight, 5mm wide

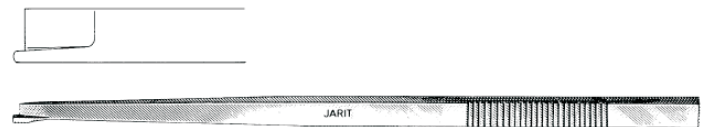

RUBIN Osteotomes, 6½" (16.5cm), with finger grip, rounded corners

- 410-316** 16mm wide
- 410-317** 14mm wide
- 410-318** 11mm wide

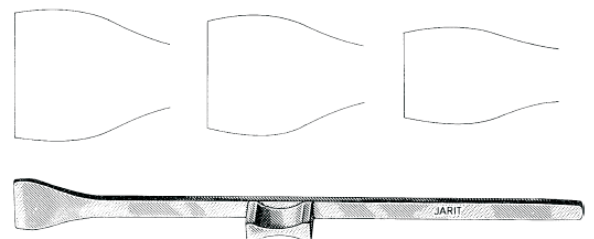

JARIT Osteotomes,
6¼" (15.9cm), hexagonal handle

- | | | | |
|----------------|----------|----------------|-----------|
| 410-319 | 2mm wide | 410-325 | 8mm wide |
| 410-320 | 3mm wide | 410-326 | 9mm wide |
| 410-321 | 4mm wide | 410-327 | 10mm wide |
| 410-322 | 5mm wide | 410-328 | 11mm wide |
| 410-323 | 6mm wide | 410-329 | 12mm wide |
| 410-324 | 7mm wide | | |

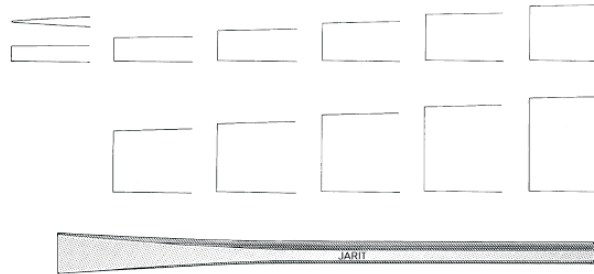

- 410-330** **JARIT** Mallet,
6¾" (17.1cm), copper,
head: weight 2.5 oz., diameter ¾" (1.9cm)



- 250-398** **JARIT** Mallet,
7¾" (18.7cm), 2 replaceable nylon caps,
anodized aluminum handle,
head: weight 4 oz., diameter 1" (2.5cm)

- 250-399** **JARIT** Mallet,
7¾" (18.7cm), 1 replaceable nylon cap and
1 stainless facing, anodized aluminum handle,
head: weight 5 oz., diameter 1" (2.5cm)

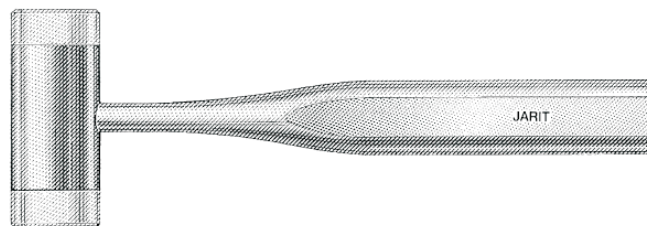

- 250-410** **NYLON** Cap for 250-398 and 250-399

CONVERSE Osteotomes,
with guard, 7½" (19cm), straight

410-332 4mm wide

410-333 5mm wide

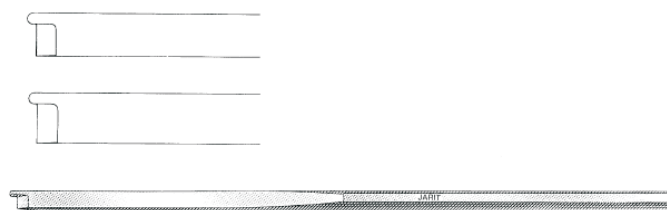

COTTLE Osteotomes,
7" (17.8cm),
with cm depth marking

410-345 4mm wide

410-346 6mm wide

410-347 8mm wide

410-348 10mm wide

410-349 12mm wide

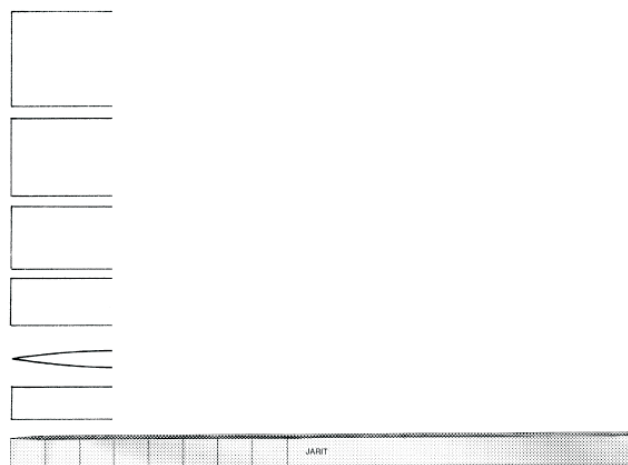

410-335 **COTTLE** Mallet,
7" (17.8cm), black aluminum handle,
one flat face and one round face,
head: weight 7oz., diameter 1½" (2.9cm)



410-340 **QUISLING** Intranasal Hammer,
6¾" (17.2cm)

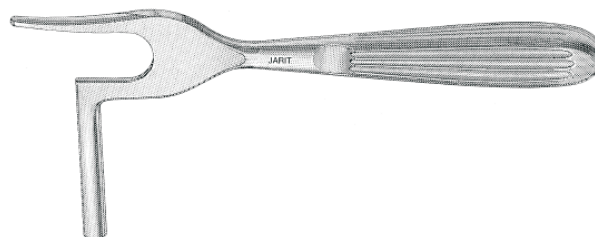

RAGNELL Undermining Scissors,
5½" (13cm)

- 415-100 Straight
- 415-101 Half curve
- 415-102 Full curve

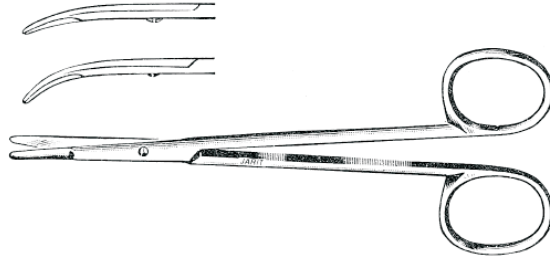

415-105 CINELLI Lower Lateral Scissors,
4½" (11.4cm), full curve

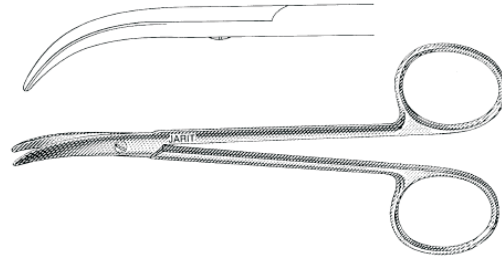

415-110 FOMON Lower Lateral Scissors,
5" (12.7cm), full curve

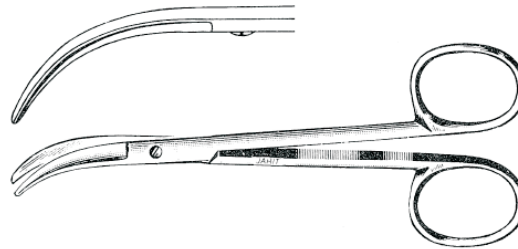

415-112 JARIT Lower Lateral Scissors,
6½" (16.5cm), full curve

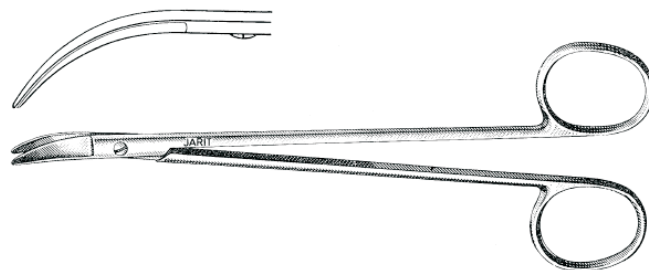

415-114 **JARIT** Dorsal Scissors,
4 $\frac{3}{4}$ " (12cm), straight

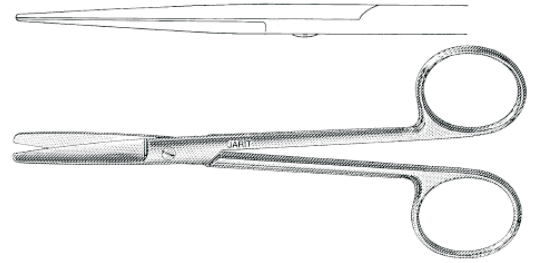

415-115 **FOMON** Dorsal Scissors,
5 $\frac{3}{4}$ " (14.6cm), angled handles

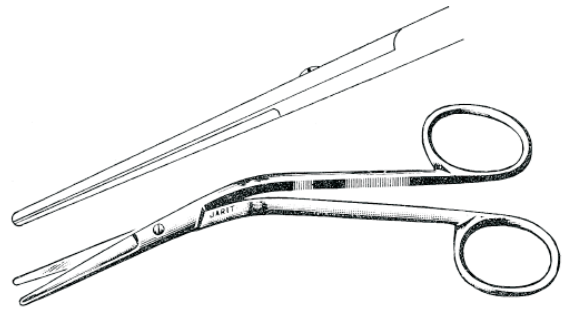

415-116 **GOLDMAN** Dorsal or Septum Scissors,
5 $\frac{3}{4}$ " (14.6cm), angled handles, serrated blades

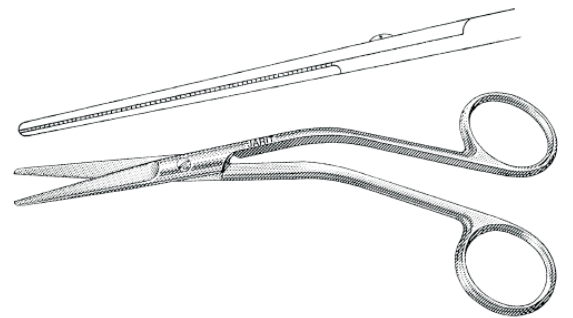

415-117 **COTTLE** Dorsal Scissors,
6 $\frac{1}{2}$ " (16.5cm), heavy, angled handles

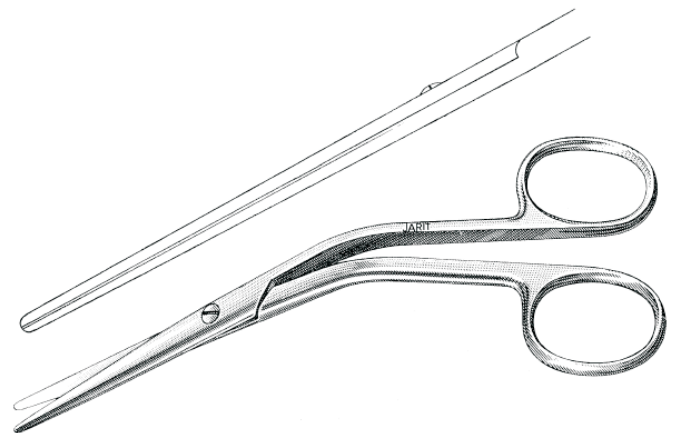

415-118 CAPLAN Nasal Bone Scissors,
7½" (19.1cm), double action, serrated blades

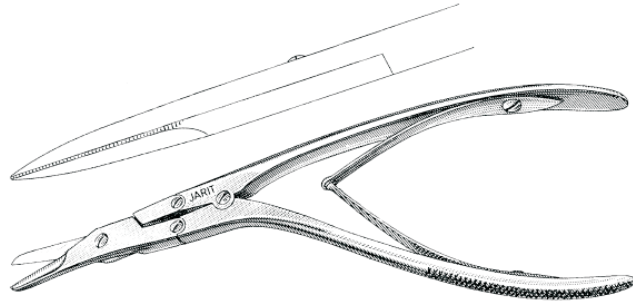

415-119 COTTLE Septum Scissors,
7" (17.8cm), angled handles, serrated blades

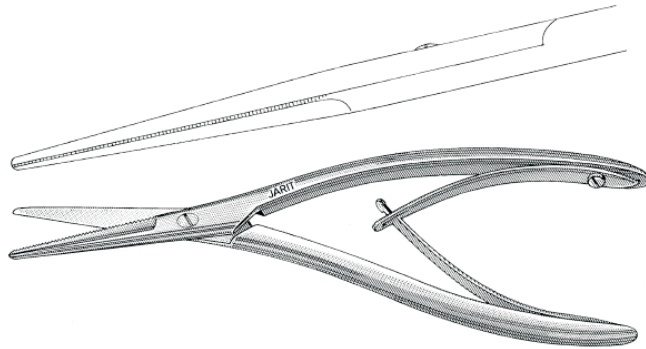

415-120 MILLER Dissecting Scissors,
5" (12.7cm), semi-sharp outer edges

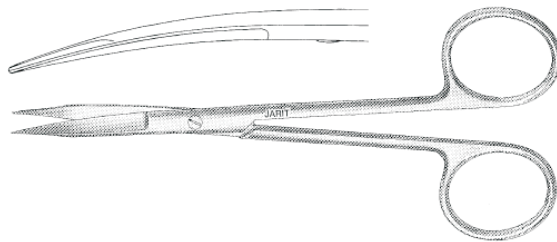

415-121 KAYE Dissecting Scissors,
4¼" (10.8cm), curved, serrated blades

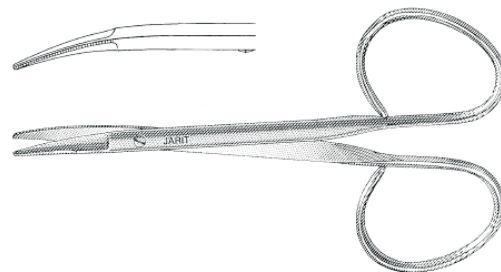

415-123 FOMON Saber Back Scissors,
5½" (14cm), curved,
semi-sharp outer edges

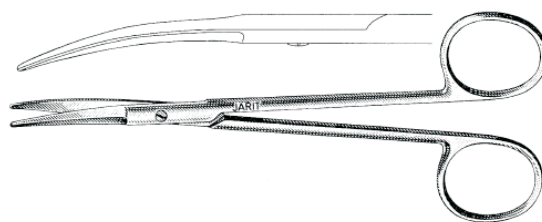

415-124 GOLDMAN Nasal Scissors,
5¾" (14.6cm), curved,
semi-sharp outer edges

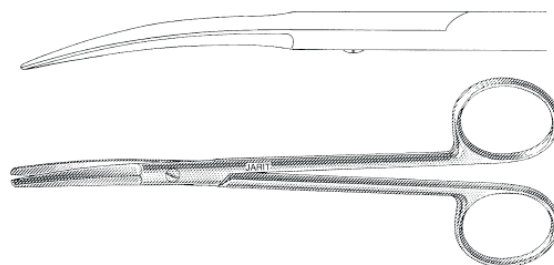

415-125 AUFRICHT Nasal Scissors,
5½" (14cm), curved,
semi-sharp outer edges

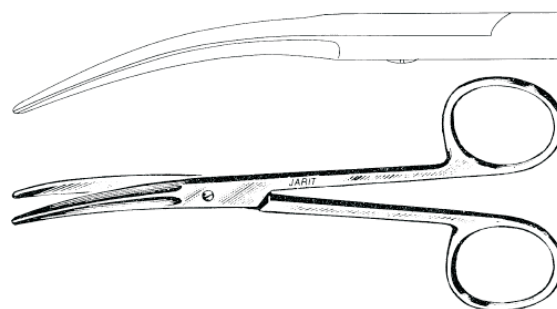

415-127 JACKSON Nasal Bone Scissors,
7¾" (20cm), angled, heavy pattern

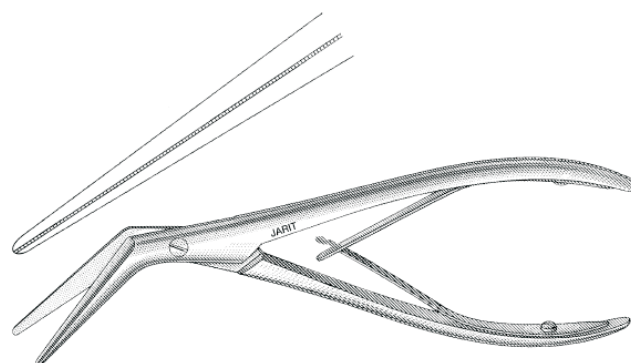

415-130 **BECKER** Septum Scissors,
7½" (18cm), serrated blades

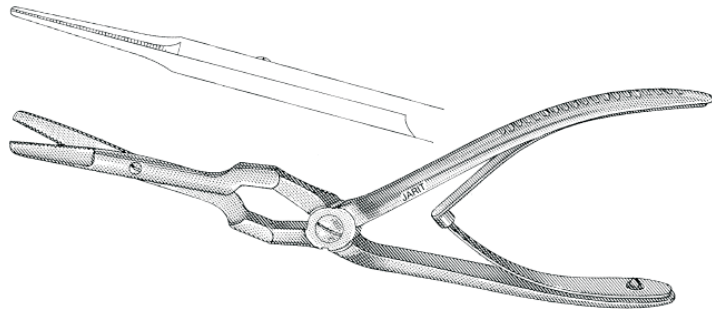

415-133 **GORNEY** Turbinate Scissors,
8" (20.3cm), double action,
serrated blades

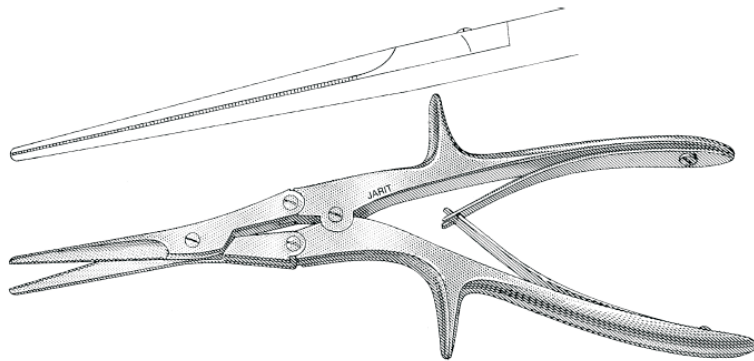

BROPHY Gum and Suture Scissors,
5¾" (14.6cm), sharp

415-140 Straight

415-141 Curved

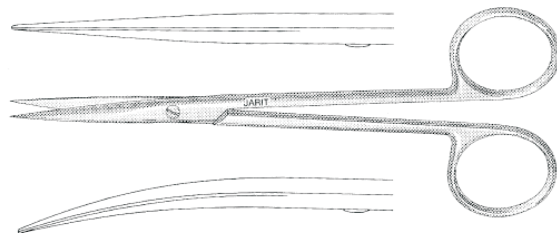

415-145 **LITTLER** Suture Carrying Scissors,
4¾" (12.1cm), curved

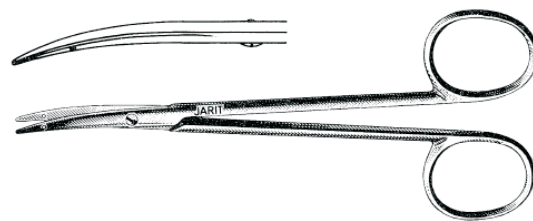

BROWN Dissecting Scissors,
5½" (14cm), heavy handles,
narrow blades

- 415-150 Straight
- 415-152 Curved

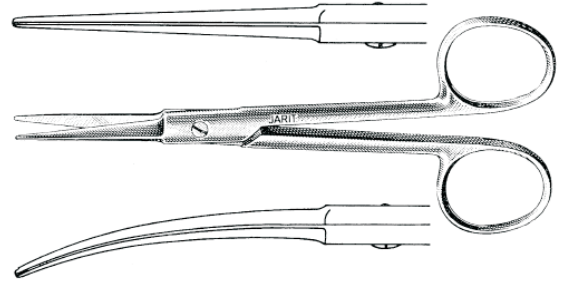

BROWN Dissecting Scissors,
5¾" (14.6cm)

- 415-170 Straight
- 415-172 Curved

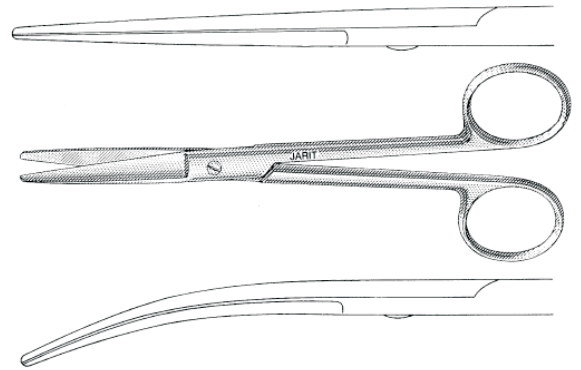

METZENBAUM (LAHEY) Scissors,
5¾" (14.6cm)

- 100-250 Straight
- 100-251 Curved

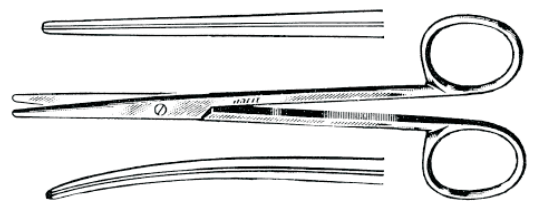

100-261 **METZENBAUM** Scissors,
7" (17.8cm), curved, slender, delicate

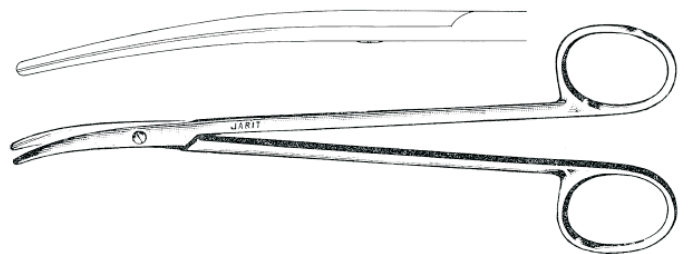

JARIT Scissors,
5¼" (13.3cm), delicate, dissecting tips

- 100-269 Straight
- 100-270 Curved

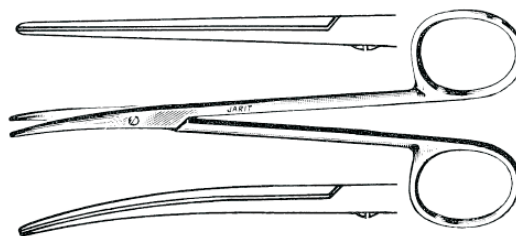

- 100-272 **METZENBAUM (LAHEY)** Scissors
5¾" (14.6cm), curved, delicate

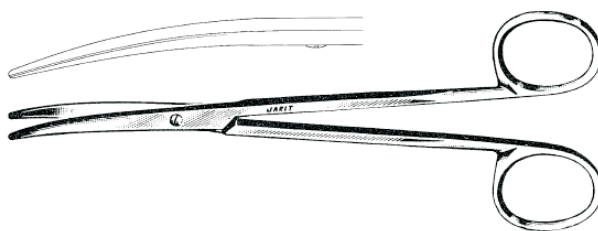

JOSEPH Scissors,
5¾" (14.6cm)

- 100-278 Straight
- 100-279 Curved

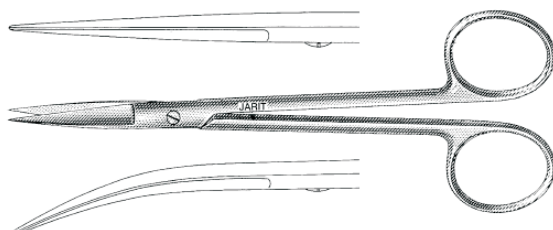

JARIT Flat Tip Scissors,
curved

- 100-290 5" (12.7cm)
- 100-291 7" (17.8cm)

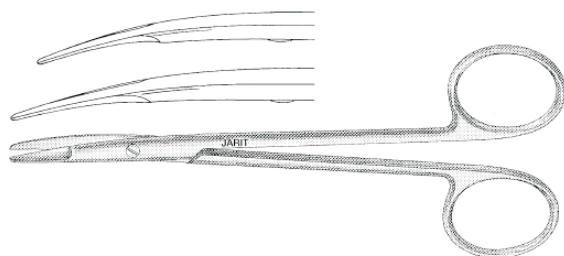

PLASTIC SURGERY Scissors,
4¾" (12.1cm), 33mm blades, sharp-blunt

- 100-320** Straight
- 100-322** Curved

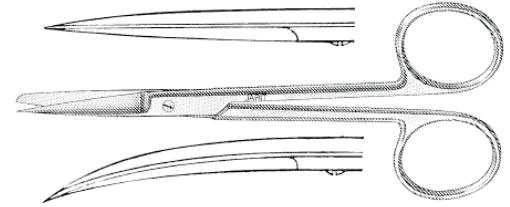

PLASTIC SURGERY Scissors,
4¾" (12.1cm), 33mm blades, sharp-sharp

- 100-325** Straight
- 100-327** Curved

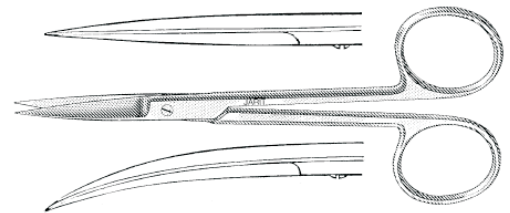

PLASTIC SURGERY Scissors,
4¾" (12.1cm), 33mm blades, blunt-blunt

- 100-330** Straight
- 100-332** Curved

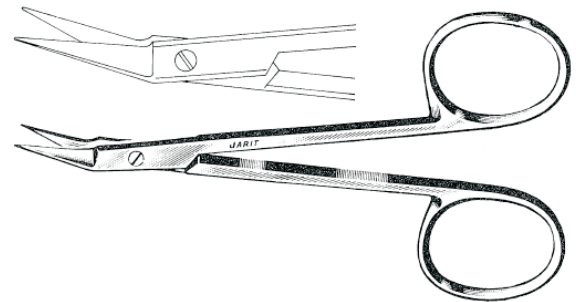
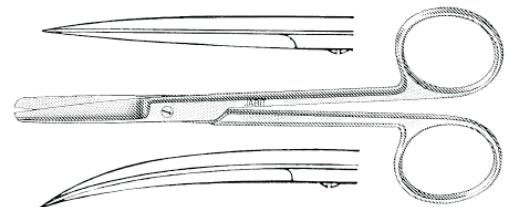

- 125-195** **O'BRIEN** Suture Scissors,
3¾" (9.5cm), angled

KNAPP Iris Scissors,
4" (10.1cm), 25mm blades, sharp-sharp

- 360-090** Straight
- 360-093** Curved

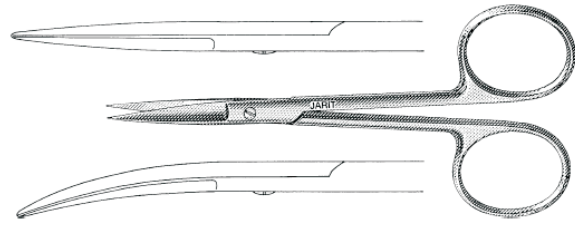

KNAPP Iris Scissors,
4" (10.1cm), 25mm blades, sharp-blunt

- 360-091** Straight
- 360-094** Curved

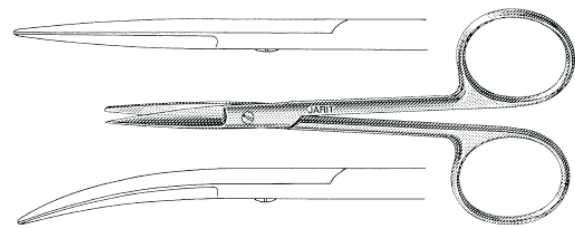

KNAPP Iris Scissors,
4" (10.1cm), 25mm blades, blunt-blunt

- 360-092** Straight
- 360-095** Curved

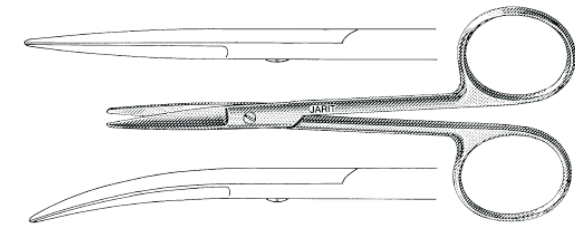

IRIS Scissors,
4½" (11.4cm), 25mm blades

- 360-100** Straight
- 360-101** Curved

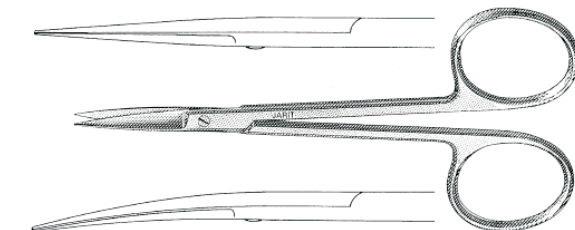

- 360-102** **IRIS** Scissors,
4½" (11.4cm), 25mm blades,
angled over edge

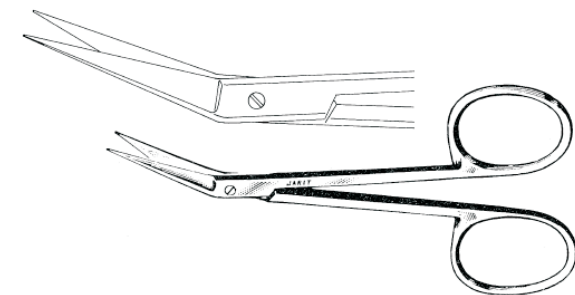

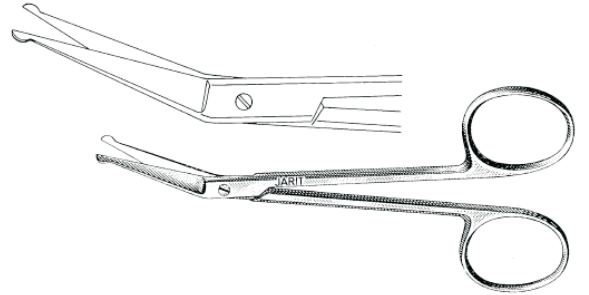

360-103 **IRIS** Scissors,
4½" (11.4cm), 25mm blades,
angled over edge, probe points

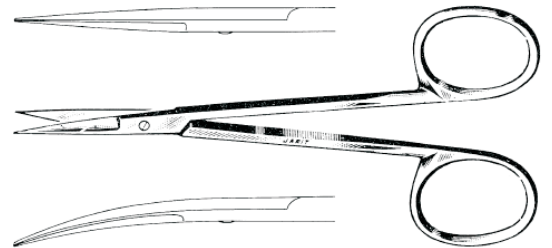

IRIS Scissors,
25mm blades
360-104 3½" (8.9cm), straight
360-105 3½" (8.9cm), curved
360-110 4½" (10.5cm), extra delicate, straight
360-111 4½" (10.5cm), extra delicate, curved

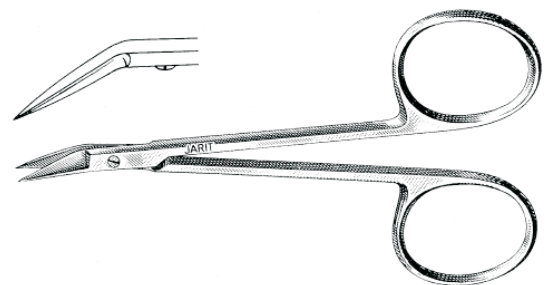

360-115 **WILMER** Conjunctival Scissors,
4½" (10.5cm), delicate, 15mm blades,
angled on flat

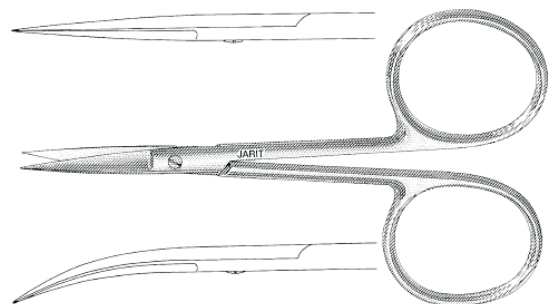

IRIS Scissors,
4" (10.1cm), 24mm blades,
large finger rings
360-117 Straight
360-118 Curved

IRIS Scissors,
4½" (10.5cm), delicate, 27mm blades

- 360-120** Straight
- 360-121** Curved

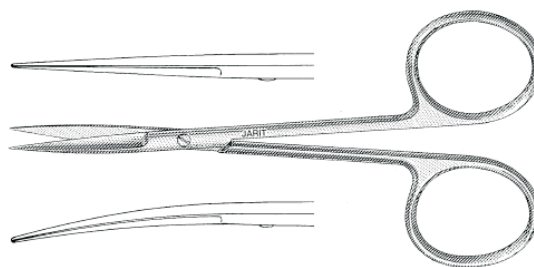

IRIS Scissors,
4" (10.1cm), 22mm blades,
flat shanks

- 360-122** Straight
- 360-123** Curved

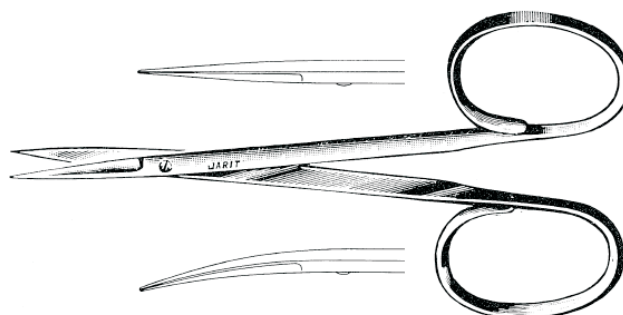

IRIS Scissors,
3½" (8.9cm), delicate, 12mm blades,
flat shanks

- 360-125** Straight
- 360-126** Curved

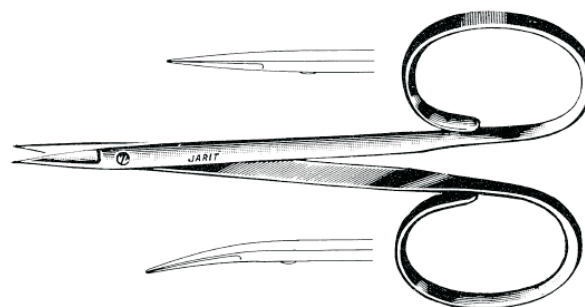

JARIT Utility Scissors,
4½" (10.5cm), 15mm blades,
flat shanks

- 360-127** Straight
- 360-128** Curved

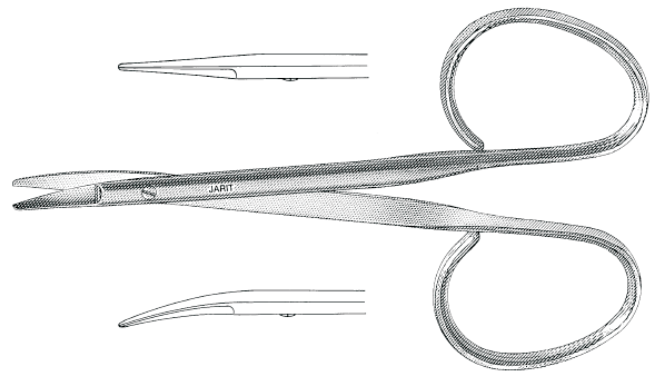

STRABISMUS Scissors,
4½" (11.4cm), 30mm blades

- 360-130** Straight
- 360-131** Curved

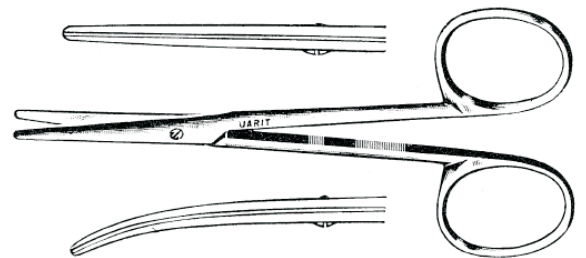

STRABISMUS Scissors,
4½" (10.5cm), 25mm blades,
flat shanks

- 360-134** Straight
- 360-135** Curved

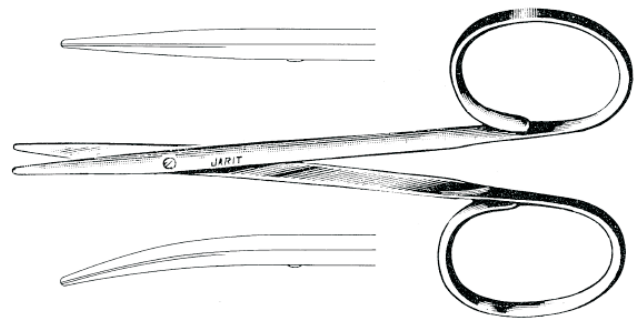

JARIT SCISSORS

- STEVENS** Tenotomy Scissors,
blunt tips
- Standard Supercut
- 360-138 102-138** 4½" (11.4cm), 13mm blades,
straight, slender pattern
- 360-139 102-139** 4½" (11.4cm), 13mm blades,
curved, slender pattern
- 360-140 102-140** 4½" (10.5cm), 12mm blades,
straight, standard pattern
- 360-141 102-141** 4½" (10.5cm), 12mm blades,
curved, standard pattern

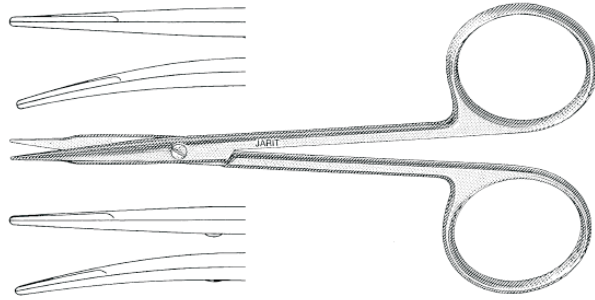

- STEVENS** Tenotomy Scissors,
3¾" (9.5cm), 13mm blades,
blunt tips, flat shanks
- 360-142** Straight
- 360-143** Curved

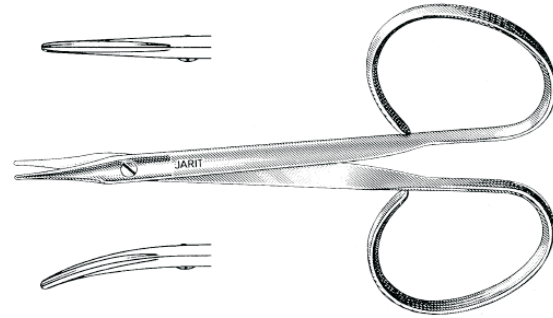

- 360-148** **STEVENS** Stitch Scissors,
4½" (10.5cm), 14mm blades,
curved, sharp tips

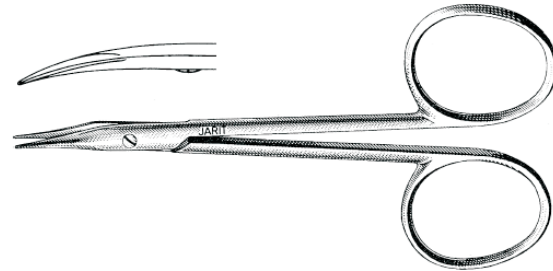

- 360-149** **STEVENS** Stitch Scissors,
3¾" (9.5cm), 12mm blades,
curved, sharp tips, flat shanks

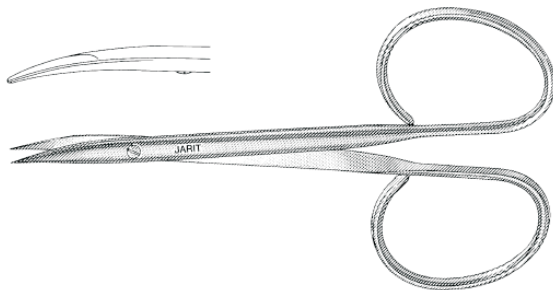

- JARIT** Stitch Scissors,
3¾" (9.8cm), 15mm blades,
semi-sharp tips
- 360-154** Straight
- 360-155** Curved

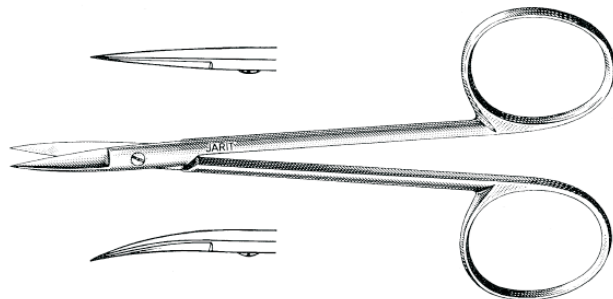

JARIT[®] CARB-EDGE SCISSORS

These superbly crafted instruments have solid inserts of a hard, tough alloy permanently welded to the scissors, and are vacuum hardened. This alloy, composed principally of tungsten, cobalt, chromium and carbon, is harder than stainless steel (61 to 65 Rockwell C). Cutting edges of JARIT CARB-EDGE Scissors stay sharp longer than those of ordinary scissors because of the high transfer rupture strength of the blade inserts.

The material is also highly resistant to corrosion, further prolonging its useful life.

JARIT CARB-EDGE Scissors are guaranteed to stay sharp for at least three years of normal usage. If sharpening should be required during the guarantee period, it will be done without charge. Finger rings are gold plated for easy identification.

METZENBAUM (LAHEY) Scissors,
delicate

101-250 5¼" (14.6cm), straight

101-251 5¼" (14.6cm), curved

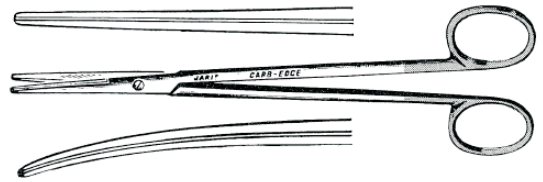

METZENBAUM (LAHEY) Scissors,
delicate, sharp-sharp

101-252 5¼" (14.6cm), straight

101-253 5¼" (14.6cm), curved

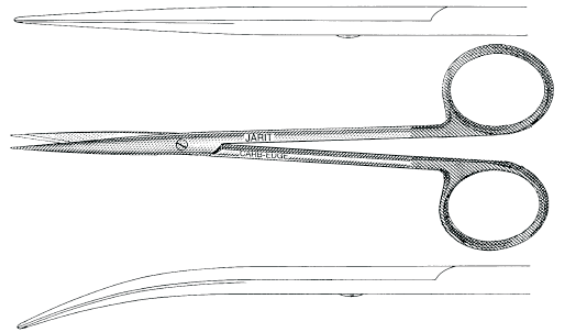

101-255 **PETIT-POINT REYNOLDS Scissors,**
5" (12.7cm) curved, one blade serrated

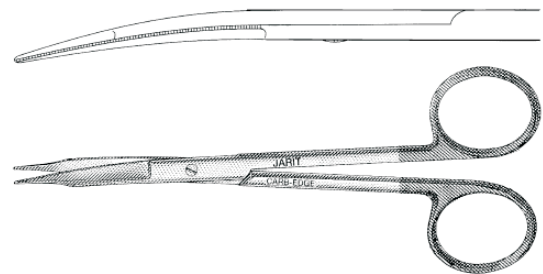

JARIT CARB-EDGE SCISSORS

METZENBAUM Scissors,
sharp-sharp

- 101-257** 7" (17.8cm) straight
- 101-259** 7" (17.8cm), curved

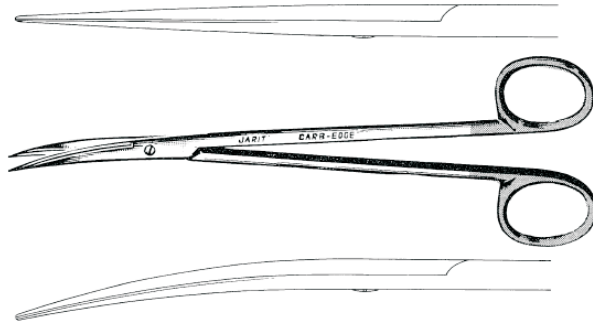

METZENBAUM Scissors,
delicate

- 101-260** 7" (17.8cm), straight
- 101-261** 7" (17.8cm), curved

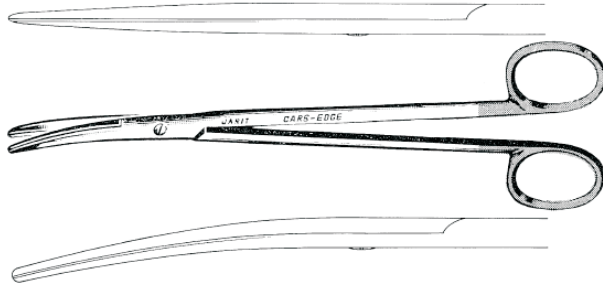

IRIS Scissors

- 101-300** 4½" (11.4cm), straight
- 101-301** 4½" (11.4cm), curved

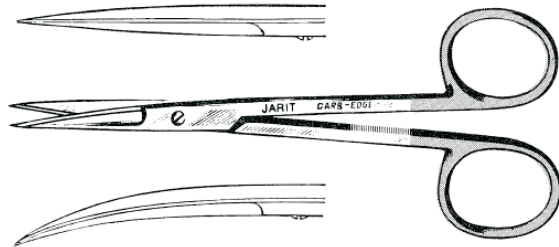

STRABISMUS Scissors

- 101-310** 4½" (11.4cm), straight
- 101-311** 4½" (11.4cm), curved

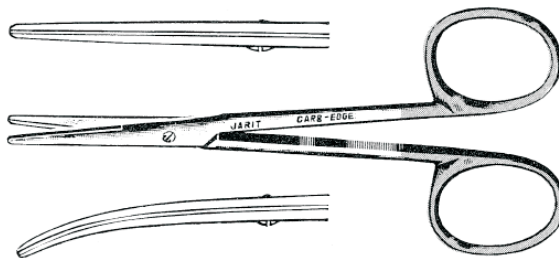

JARIT JARIT SUPERCUT SCISSORS

Developed by utilizing unique and innovative methods of grinding, sharpening and heat treating, JARIT SUPERCUT scissors have achieved a degree of sharpness never before seen on conventional surgical scissors. In the surgeon's hand, the "feel" of the cutting motion is so smooth it creates a totally new sensation of absolute control.

Laboratory tests simulating hundreds of surgical procedures, confirmed that JARIT SUPERCUT scissors retain their sharpness long after conventional scissors become dull. JARIT backs this claim with a *Date-Stamped Certified Warranty*. Finger rings are black plated for easy identification.

METZENBAUM (LAHEY) Scissors

- 102-119 5½" (14.6cm), straight
- 102-120 5½" (14.6cm), curved

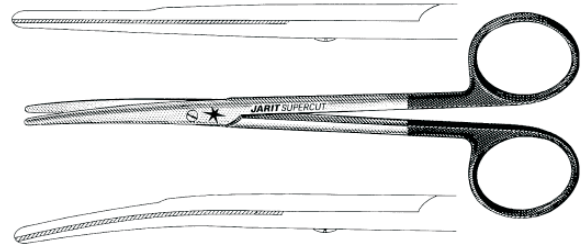

METZENBAUM Scissors

- 102-122 7" (17.8cm), curved
- 102-125 9" (22.8cm), curved

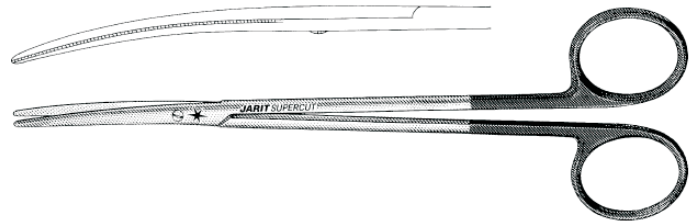

IRIS Scissors

- 102-130 4½" (11.4cm), straight
- 102-131 4½" (11.4cm), curved

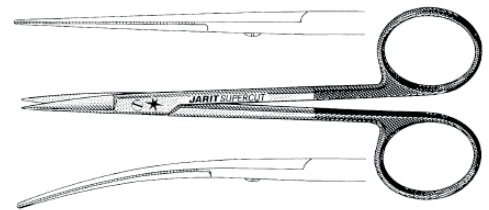

KNIGHT Nasal Scissors, 6¾" (17.1cm)

- 102-180

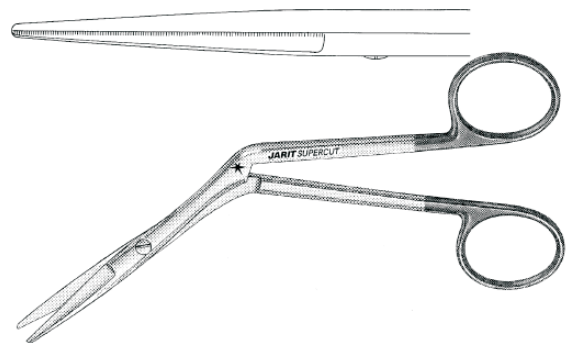

JARIT JARIT SUPERCUT SCISSORS

PLASTIC SURGERY Scissors

- 102-200 4¾" (12.1cm), straight
- 102-202 4¾" (12.1cm), curved

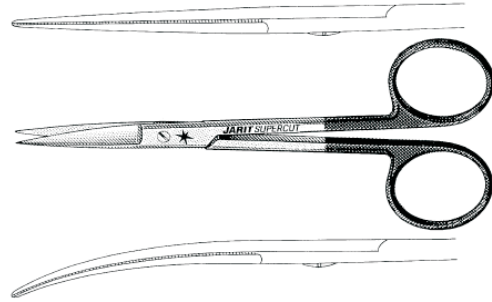

- 102-205 **CASTANARES** Face Lift Scissors, 6¼" (16cm), straight

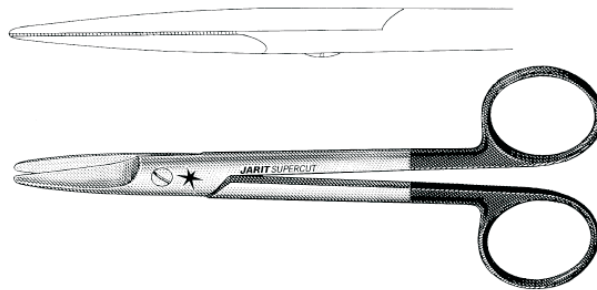

- 102-210 **GORNEY** Plastic Surgery Scissors, 7¼" (18.4cm), straight
- 102-211 7¼" (18.4cm), curved

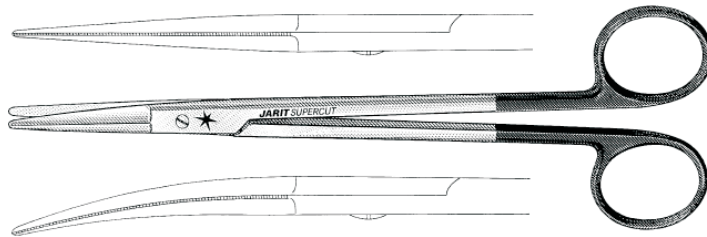

- 102-215 **KAYE** Face Lift Scissors, 6" (15.2cm), curved beveled blades have semi-sharp outer edges
- 102-216 7½" (19cm)

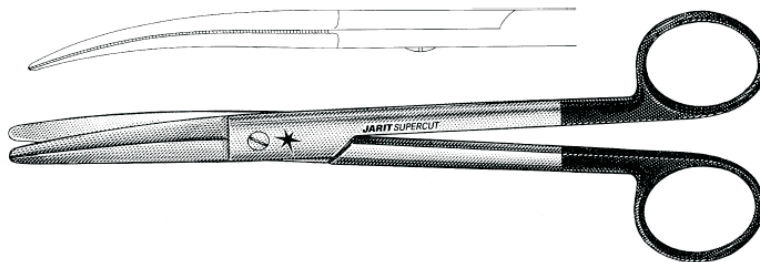

FREEMAN-GORNEY Face Lift Scissors, beveled blades have semi-sharp outer edges and flat, tapered tips; flared shanks for greater comfort and control.

- 102-220 7½" (19cm), straight
- 102-221 7½" (19cm), curved

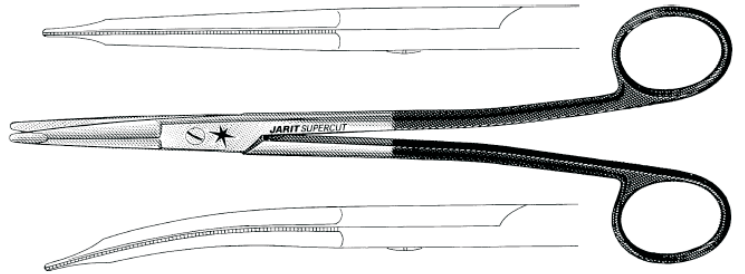

FREEMAN-KAYE Face Lift Scissors, beveled blades have semi-sharp outer edges and flat, tapered tips; flared shanks for greater comfort and control.

- 102-225 7" (17.8cm), straight
- 102-226 7" (17.8cm), curved

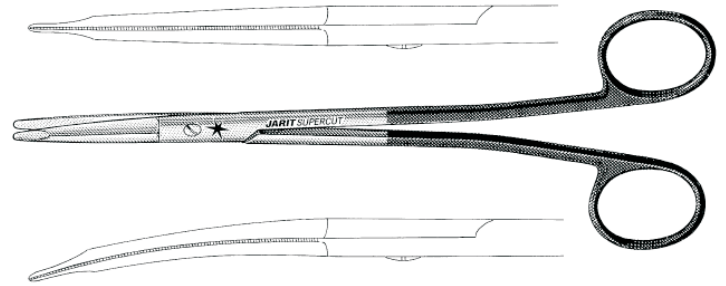

FREEMAN Rhytidectomy Scissors, with flat tips; flared shanks for greater comfort and control.

- 102-229 7" (17.8cm), curved

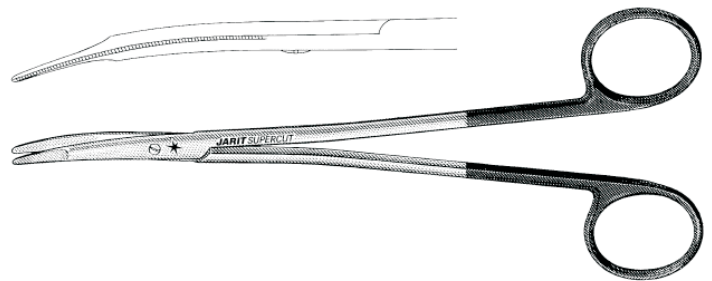

GORNEY Platysma Scissors, beveled blades have semi-sharp outer edges and flat, tapered tips; flared shanks for greater comfort and control.

- 102-230 9" (22.8cm), straight
- 102-231 9" (22.8cm), curved

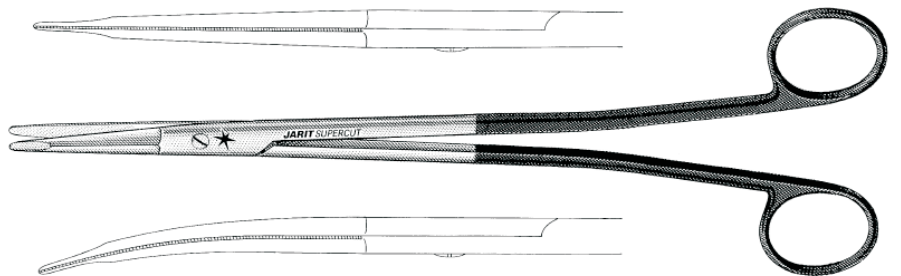

102-235 FOMON Lateral Scissors,
5" (12.7cm), full curved

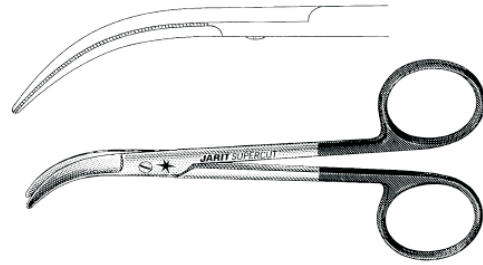

102-236 FOMON Dorsal Scissors,
5¾" (14.6cm), angled on flat

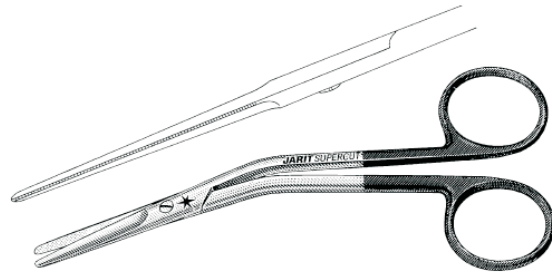

102-238 COTTLE Dorsal Scissors,
6½" (16.5cm), angled on flat

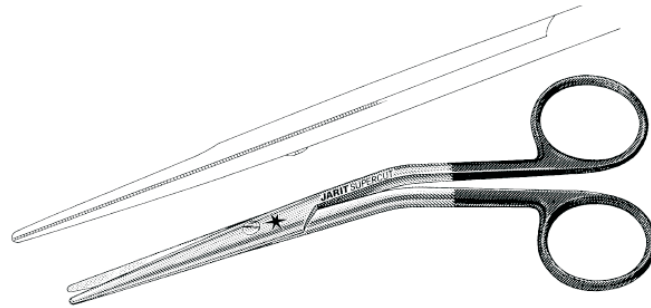

JARIT PLASTIC AND RECONSTRUCTIVE Scissors,
curved

102-240 4½" (11.4cm)
102-242 5¾" (14.6cm)

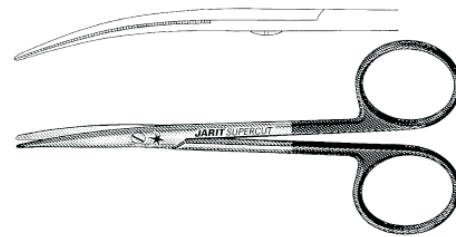

102-245 JARIT PETIT-POINT REYNOLDS Scissors,
5" (12.7cm), curved

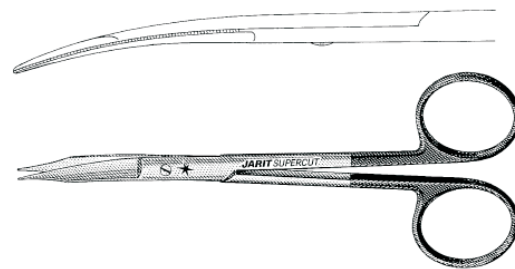

120-090 **CONVERSE** Needle Holder,
4¼" (10.8cm), large finger rings

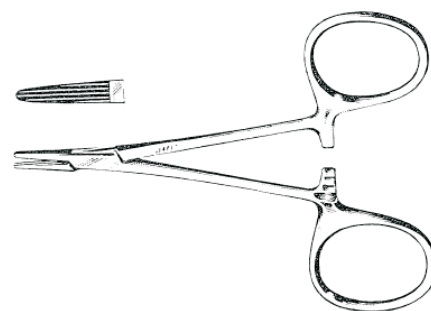

120-095 **BROWN** Needle Holder,
5¼" (13.3cm)

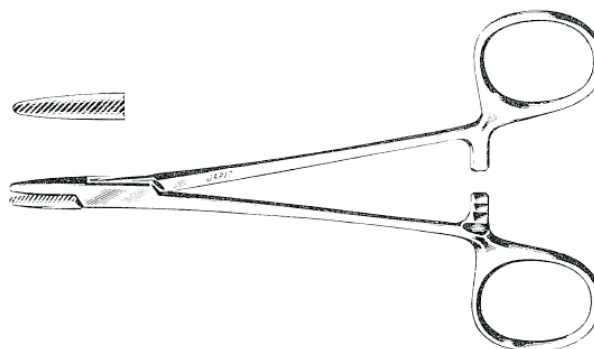

120-097 **NEIVERT** Needle Holder,
5" (12.7cm), thumb ring turned up

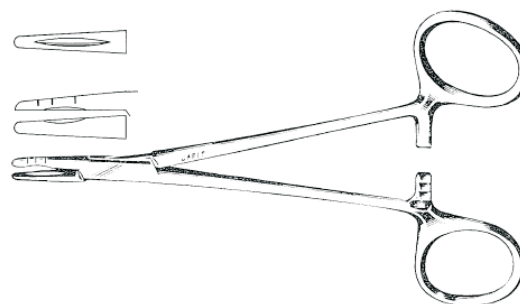

120-100 **DERF** Needle Holder,
4¾" (12.1cm)

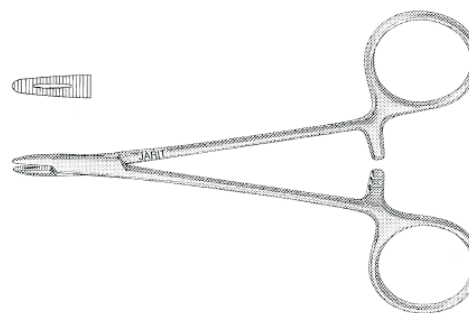

120-105 BAUMGARTNER Needle Holder,
5¼" (13.3cm), solid jaws

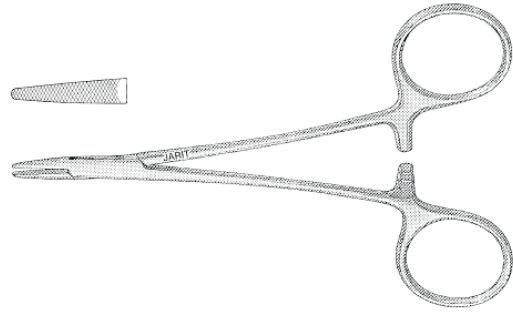

120-110 BAUMGARTNER Needle Holder,
5¼" (13.3cm), grooved jaws

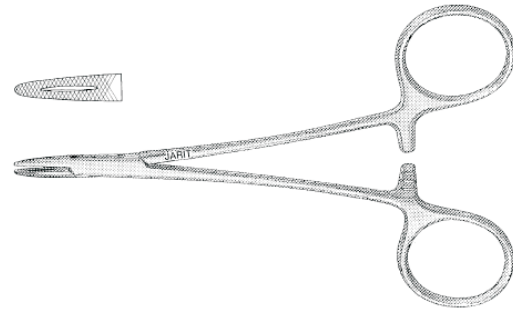

120-112 HEGAR-BAUMGARTNER Needle Holder,
5½" (14cm), solid jaws

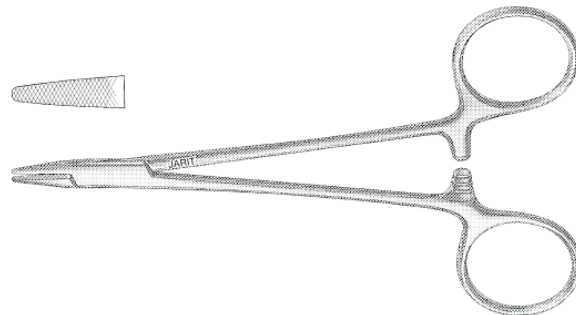

120-115 COLLIER Needle Holder,
5" (12.7cm)

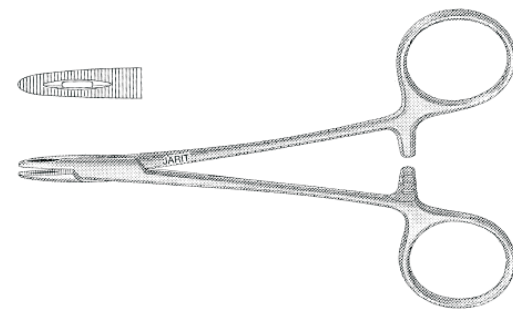

JARIT NEEDLE HOLDERS

120-118 WEBSTER Needle Holder,
4½" (11.4cm), smooth jaws

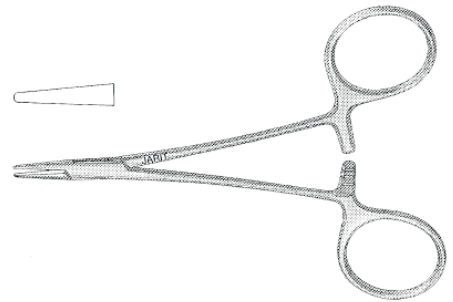

120-120 HALSEY Needle Holder,
5" (12.7cm), smooth jaws

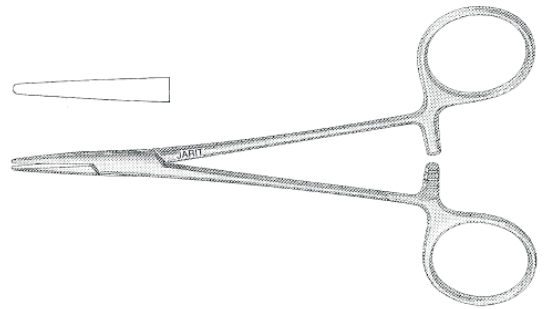

CRILE-WOOD Needle Holders

120-130 6" (15.2cm)
120-131 7" (17.8cm)

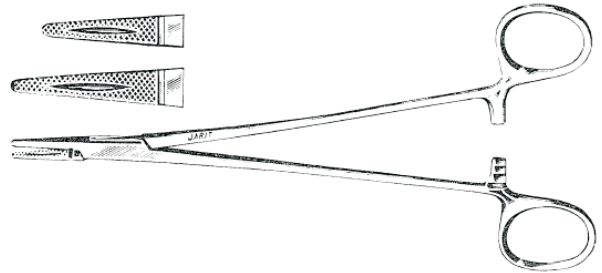

PETIT-POINT OLSEN-HEGAR Needle Holders,
5" (12.7cm), delicate

120-148 Serrated
120-149 Smooth

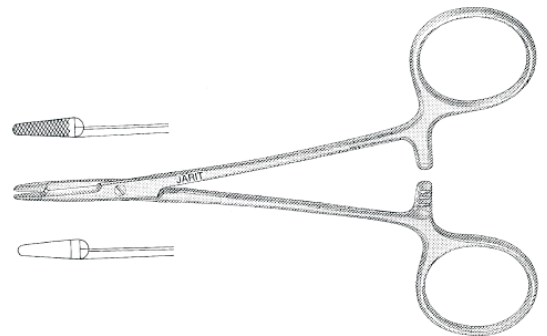

120-215 JARIT Bayonet Needle Holder,
6¾" (17.1cm), fine tapered jaws

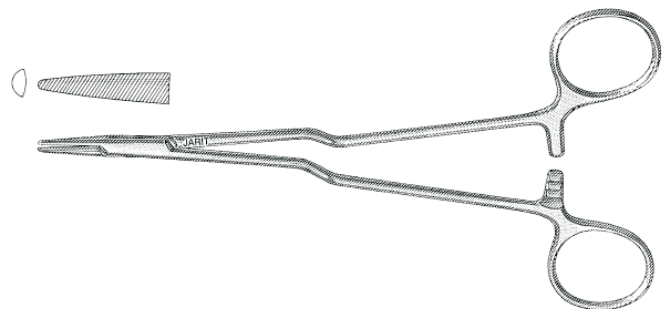

JARIT CARB-BITE NEEDLE HOLDERS

JARIT CARB-BITE Needle Holders feature jaw inserts of solid tungsten carbide. Sharply defined serrations have been milled into these inserts to provide a secure hold on the suture needle.

Because tungsten carbide is much harder than stainless steel, the useful life of CARB-BITE

Needle Holders greatly exceeds that of ordinary needle holders. JARIT CARB-BITE Needle Holders are guaranteed for a minimum of three years of normal usage. If jaw serrations should wear smooth while under guarantee, new CARB-BITE inserts will be installed without charge. Finger rings are gold plated for easy identification.

121-097 NEIVERT Needle Holder,
5" (12.7cm), thumb ring turned up

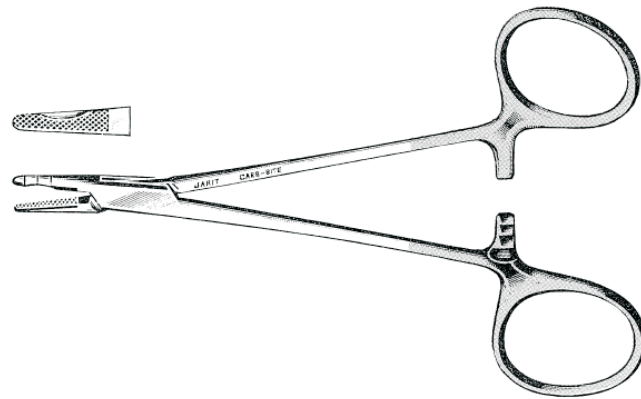

121-100 DERF Needle Holder,
4¾" (12.1cm)

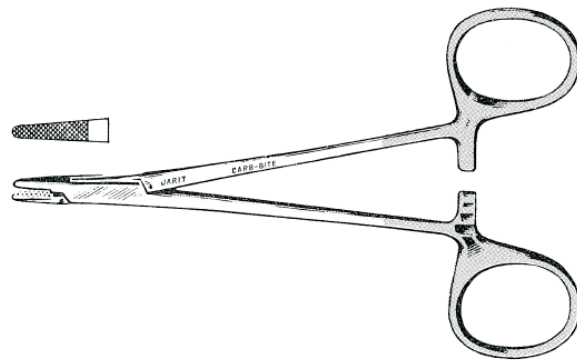

121-105 BAUMGARTNER Needle Holder,
5¼" (13.3cm)

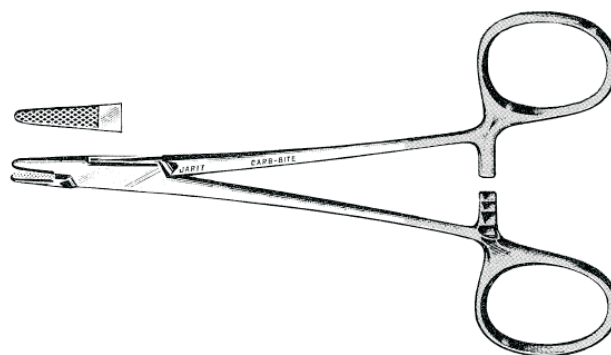

JARIT CARB-BITE NEEDLE HOLDERS

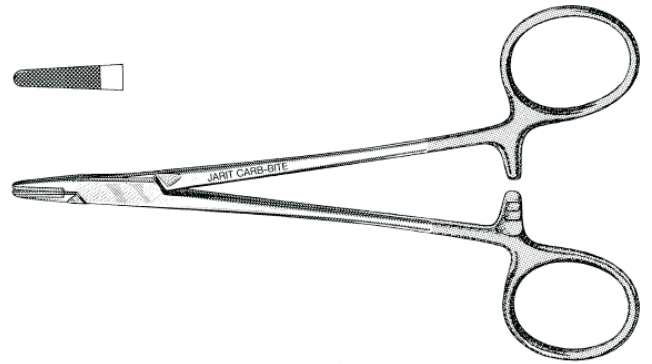

121-106 HEGAR-BAUMGARTNER Needle Holder,
5½" (14cm)

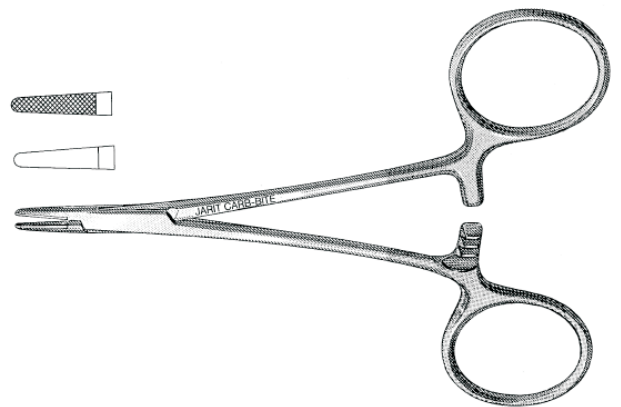

JARIT PLASTIC AND RECONSTRUCTIVE Needle Holders
121-115 4½" (12cm), serrated
121-116 4½" (12cm), smooth

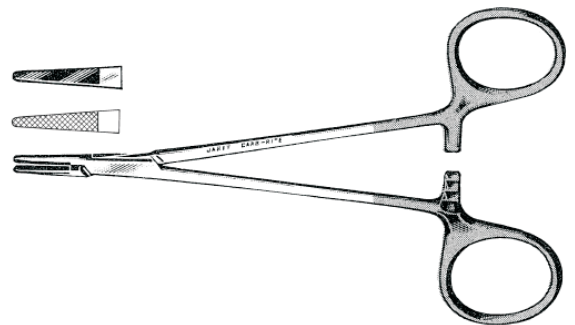

WEBSTER Needle Holder,
121-118 4½" (11.4cm), smooth
121-119 4½" (11.4cm), serrated, 3600 teeth per square inch

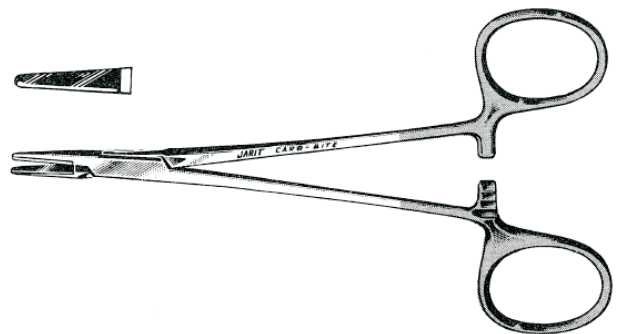

121-120 HALSEY Needle Holder,
5" (12.7cm), smooth

JARIT CARB-BITE NEEDLE HOLDERS

121-121 HALSEY Needle Holder,
5" (12.7cm), serrated

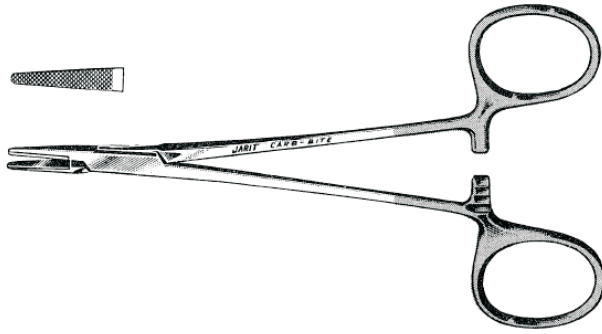

CRILE-WOOD Needle Holders

121-130 6" (15.2cm)
121-131 7" (17.8cm)

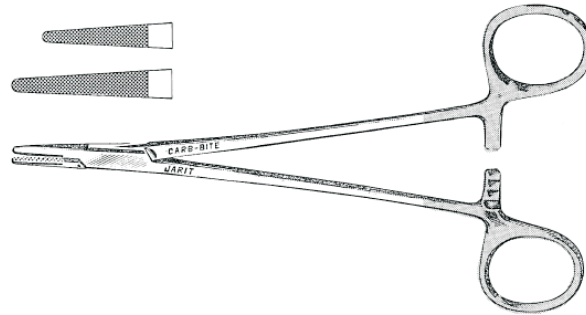

PETIT-POINT OLSEN-HEGAR Needle Holders,
5" (12.7cm), delicate

121-148 Serrated
121-149 Smooth

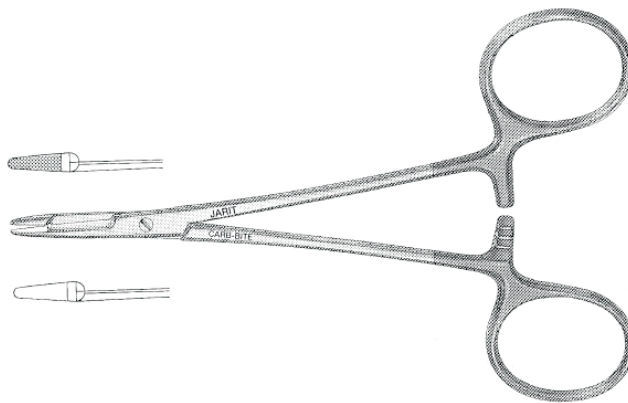

PETIT-POINT RYDER Needle Holders,
1mm jaws

121-170 5" (12.7cm), serrated
121-171 5" (12.7cm), smooth
121-172 6" (15.2cm), serrated
121-173 6" (15.2cm), smooth

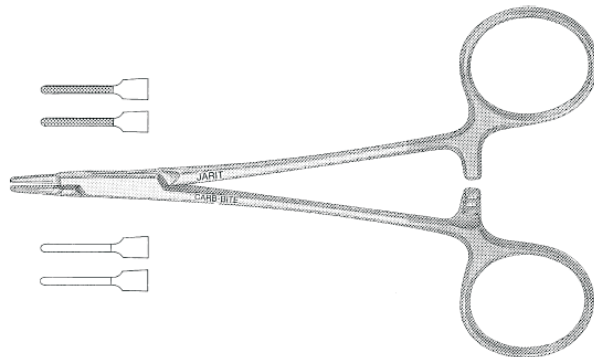

JARI NEEDLE HOLDERS

CASTROVIEJO Needle Holders,
5½" (14cm), 11mm smooth jaws,
flat serrated handle

- 355-404** Curved, lock
- 355-404NL** Curved, no lock
- 355-405** Straight, lock
- 355-405NL** Straight, no lock

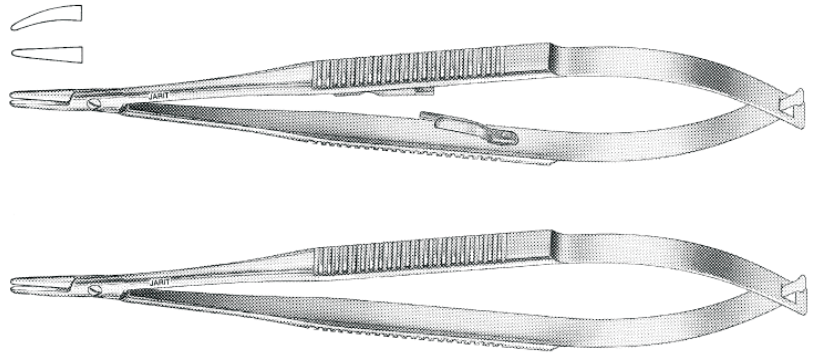

CASTROVIEJO Needle Holders,
5½" (14cm), 10mm smooth jaws,
flat serrated handle

- 355-406** Straight, lock
- 355-406NL** Straight, no lock
- 355-407** Curved, lock
- 355-407NL** Curved, no lock

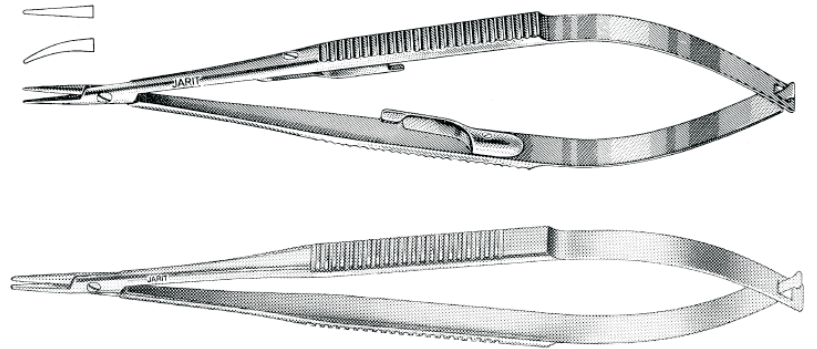

CASTROVIEJO Needle Holders,
5" (12.7cm), 9mm smooth jaws,
wide serrated handle

- 355-408** Straight, without lock
- 355-409** Curved, without lock
- 355-410** Straight, with lock
- 355-411** Curved, with lock

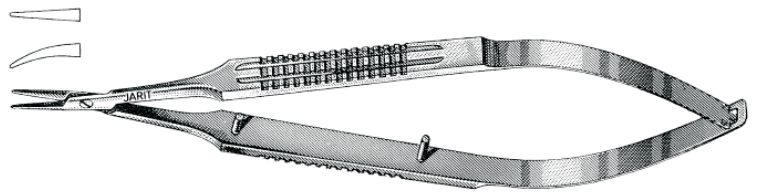

CASTROVIEJO Needle Holders,
5½" (14cm), 11mm CARB-BITE,
straight jaws, flat serrated handle

- 355-412** Smooth, lock
- 355-412NL** Smooth, no lock
- 355-413** Serrated, lock
- 355-413NL** Serrated, no lock

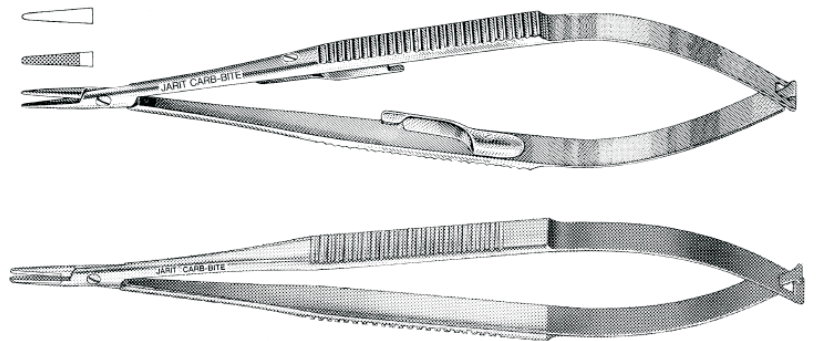

PETIT-POINT JACOBSON MOSQUITO Forceps

- 105-088 5" (12.7cm), straight
- 105-089 5" (12.7cm), curved

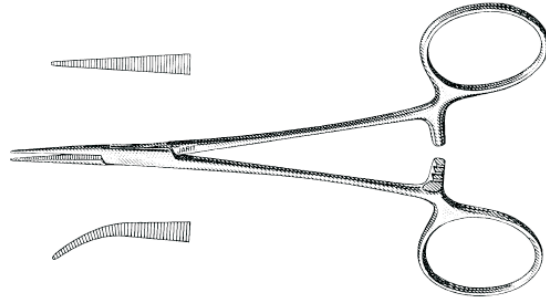

PETIT-POINT MOSQUITO Forceps

- 105-090 3 3/4" (9.8cm), straight
- 105-091 3 3/4" (9.8cm), curved
- 105-095 4 1/4" (12.1cm), straight
- 105-096 4 1/4" (12.1cm), curved

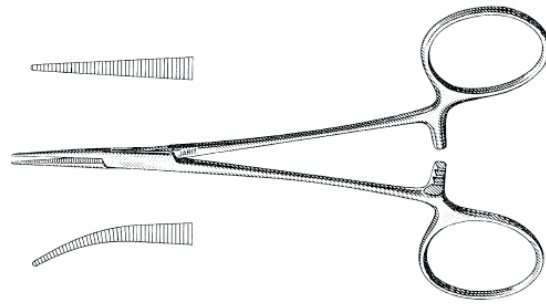

PETIT-POINT MOSQUITO Forceps

- 105-098 6" (15.2cm), straight
- 105-099 6" (15.2cm), curved

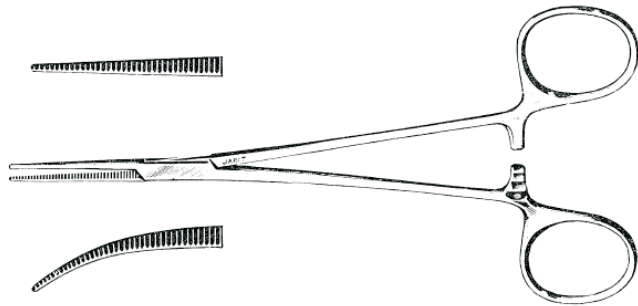

PETIT-POINT CRILE Forceps

- 105-118 5 1/2" (14cm), straight
- 105-119 5 1/2" (14cm), curved

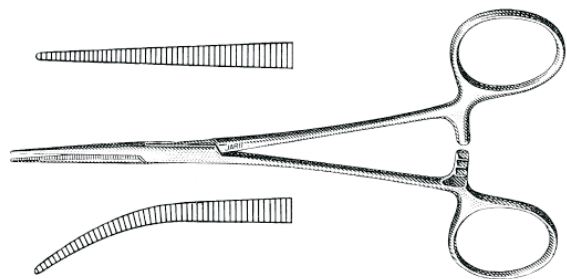

PETIT-POINT PEAN Forceps

- 105-163 5½" (14cm), straight
- 105-164 5½" (14cm), curved

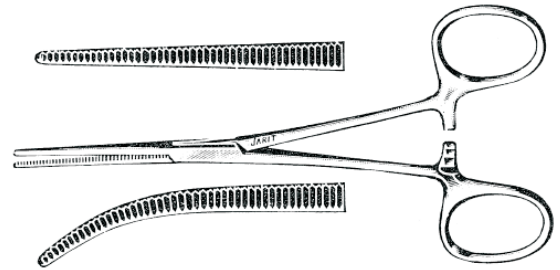

PETIT-POINT OCHSNER Forceps

- 105-233 5½" (14cm), straight
- 105-234 5½" (14cm), curved

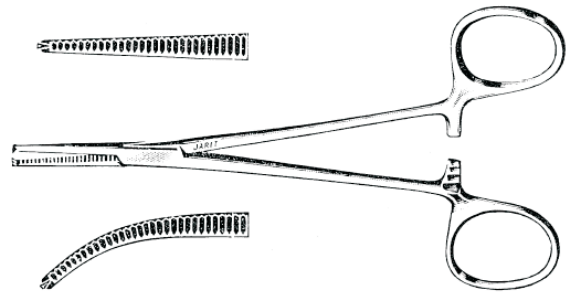

HALSTEAD Mosquito Forceps,
5" (12.7cm)

- 105-100 Straight, mirror finish
- 105-102 Curved, mirror finish
- 106-100 Straight, satin finish
- 106-102 Curved, satin finish

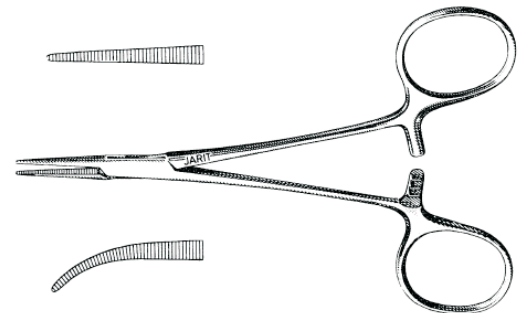

HALSTEAD Mosquito Forceps,
5" (12.7cm)

- 105-110 Straight, 1 x 2 teeth, mirror finish
- 105-112 Curved, 1 x 2 teeth, mirror finish

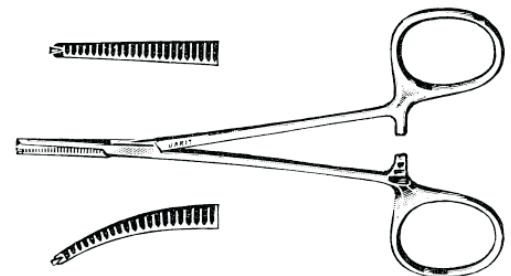

HARTMAN Mosquito Forceps,
3½" (8.9cm)

- 105-114 Straight, mirror finish
- 105-115 Curved, mirror finish

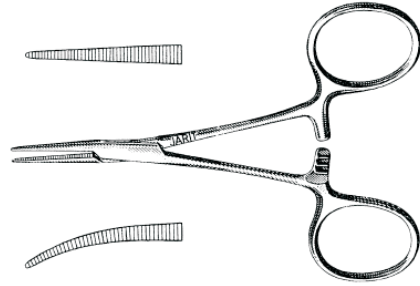

COLLER-CRILE Forceps,
fine tapered tips

- 105-142 5½" (14cm), straight, mirror finish
- 105-143 6¼" (16cm), straight, mirror finish
- 105-144 5½" (14cm), curved, mirror finish
- 105-145 6¼" (16cm), curved, mirror finish

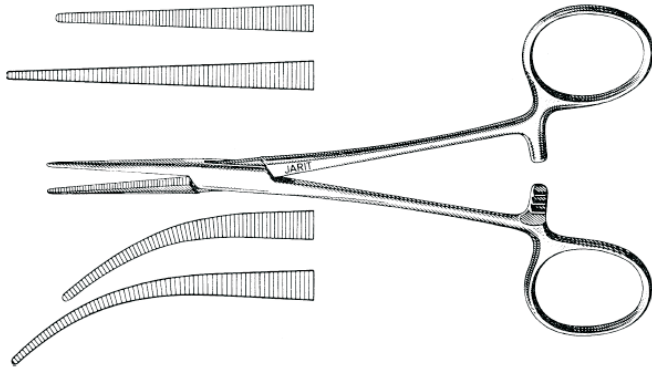

PROVIDENCE HOSPITAL Forceps

- 105-160 5½" (14cm), straight, mirror finish
- 105-161 5½" (14cm), curved, mirror finish

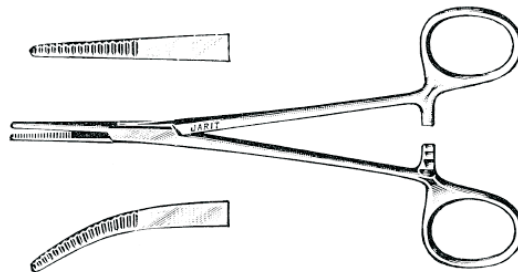

KOCHER Forceps

- 105-230 5½" (14cm), straight, mirror finish
- 105-232 5½" (14cm), curved, mirror finish

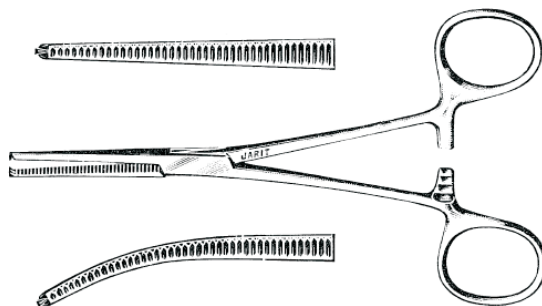

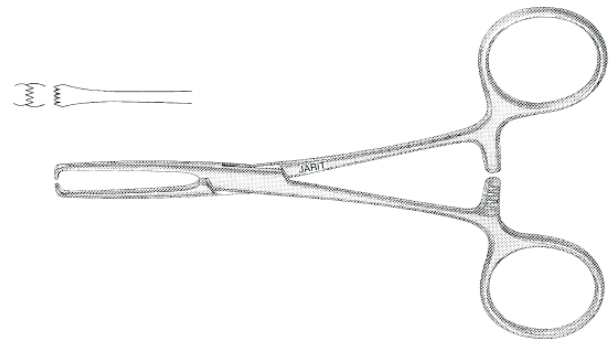

135-095 **PETIT-POINT ALLIS** Tissue Forceps,
5¼" (13.3cm), 4 x 5 teeth

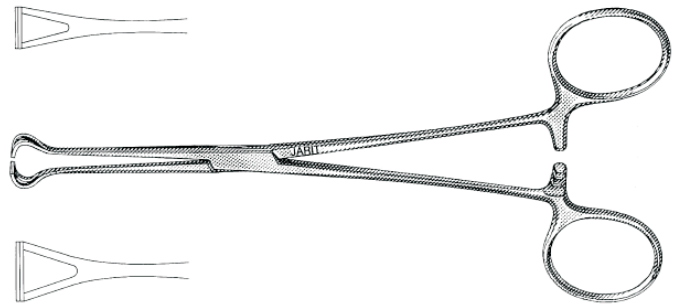

PETIT-POINT BABCOCK Forceps
135-179 5¾" (14.6cm), jaw width 6mm
135-180 6¼" (16cm), jaw width 7.5mm

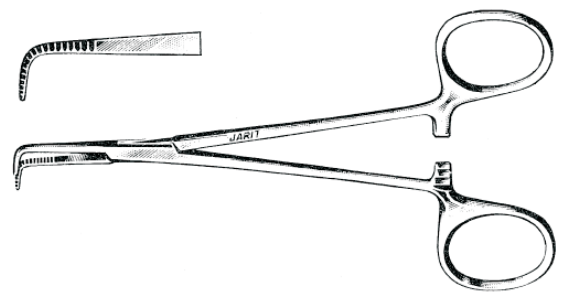

140-218 **PETIT-POINT MIXTER** Forceps,
5¼" (13.3cm)

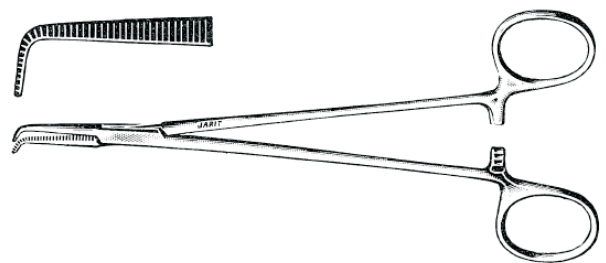

140-223 **PETIT-POINT MIXTER** Forceps,
7¼" (18.4cm)

JARIT DRESSING AND TISSUE FORCEPS

ADSON Dressing Forceps,
serrated

- 130-230 4 3/4" (12.1cm)
- 130-231 4 3/4" (12.1cm), extra delicate, 0.8mm wide tip

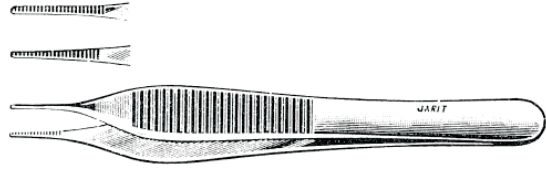

- 130-232 **ADSON** Dressing Forceps,
4 3/4" (12.1cm), cross-serrated



ADSON Tissue Forceps,
1 x 2 teeth

- 130-234 4 3/4" (12.1cm)
- 130-235 4 3/4" (12.1cm), extra delicate, 0.8mm wide tip
- 130-237 4 3/4" (12.1cm), angled
- 130-238 4 3/4" (12.1cm), with tying platform

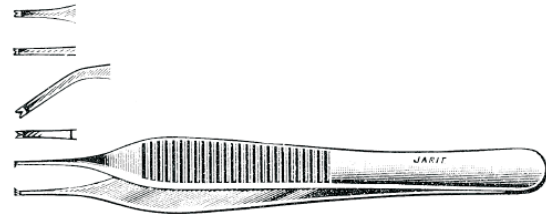

- 130-236 **ADSON** Tissue Forceps,
4 3/4" (12.1cm), CARB-BITE tips

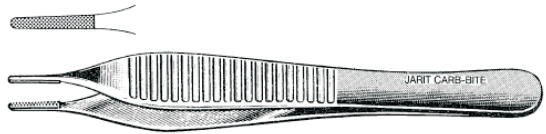

- 130-240 **ADSON** Tissue Forceps,
4 3/4" (12.1cm), 2 x 3 teeth

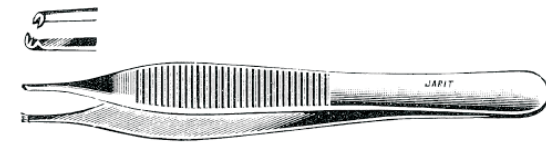

- 130-245 **ADSON** Tissue Forceps,
4 3/4" (12.1cm), 1 x 2 teeth, serrated

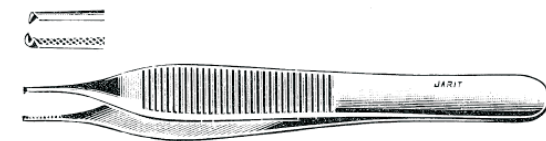

130-260 BROWN-ADSON Tissue Forceps,
4¾" (12.1cm), 9 x 9 teeth

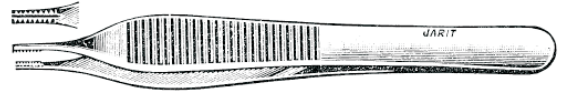

130-262 BEASLEY-BABCOCK Tissue Forceps,
5" (12.7cm), 6 x 7 teeth

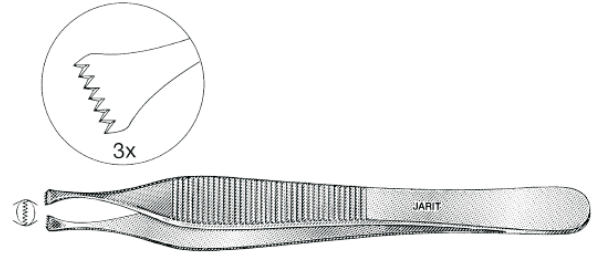

BROWN Tissue Forceps,
8 x 8 teeth

- 130-265** 6" (15.2cm)
- 130-266** 8" (20.3cm)
- 130-267** 10" (25.4cm)



130-270 BROWN-ADSON Tissue Forceps,
4¾" (12.1cm), 9 x 9 teeth, angled

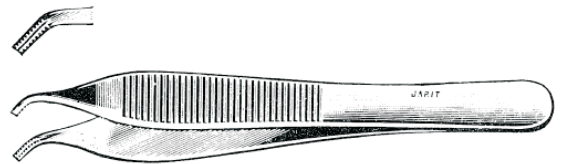

SEMKEN Dressing Forceps,
serrated

- 130-275** 4¾" (12.1cm)
- 130-276** 6" (15.2cm)



SEMKEN Tissue Forceps

- 130-280** 4¾" (12.1cm), 1 x 2 teeth
- 130-281** 6" (15.2cm), 1 x 2 teeth
- 130-282** 4¾" (12.1cm), 2 x 3 teeth

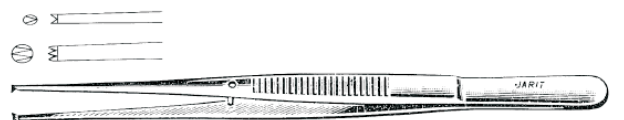

JARIT DRESSING AND TISSUE FORCEPS

130-284 **McINDOE** Dressing Forceps,
6" (15.2cm), serrated

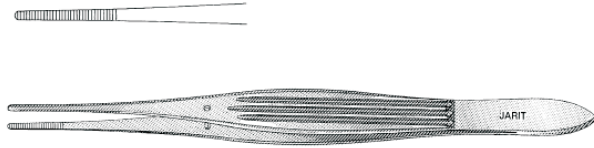

130-286 **GILLIES** Tissue Forceps,
6" (15.2cm), 1 x 2 teeth, cross-serrated

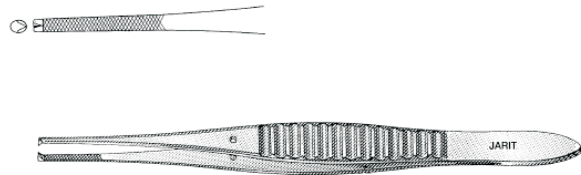

FERRIS-SMITH Tissue Forceps

130-289 6 3/4" (17.1cm), 1 x 2 teeth

130-290 6 3/4" (17.1cm), 2 x 3 teeth

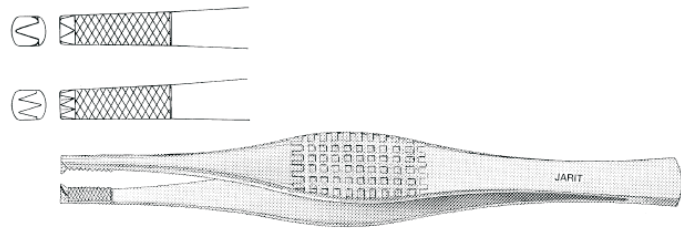

BONNEY Tissue Forceps

130-293 6 3/4" (17.1cm), 1 x 2 teeth

130-294 6 3/4" (17.1cm), 2 x 3 teeth

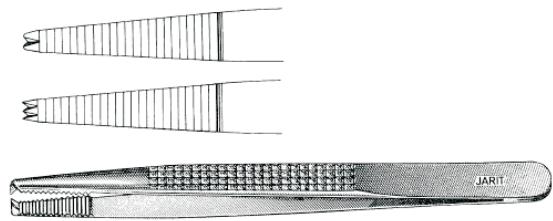

130-370 NELSON Tissue Forceps,
6" (15.2cm), 6 x 7 teeth

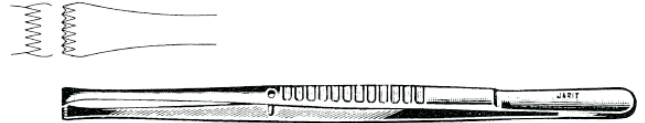

130-405 CUSHING Tissue Forceps,
7" (17.8cm), straight,
1 x 2 teeth, scraper end



130-415 CUSHING Tissue Forceps,
7 1/4" (18.4cm), bayonet,
1 x 2 teeth, scraper end

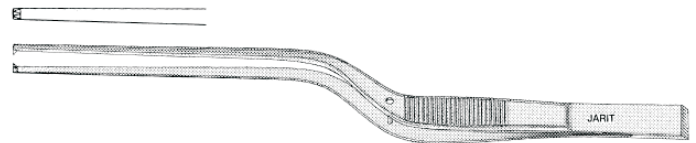

130-440 CUSHING-BROWN Tissue Forceps,
7" (17.8cm), straight, double row
of 9 x 9 delicate teeth, scraper end



130-442 CUSHING-BROWN Tissue Forceps,
7 1/4" (18.4cm), bayonet, double row
of 9 x 9 delicate teeth, scraper end

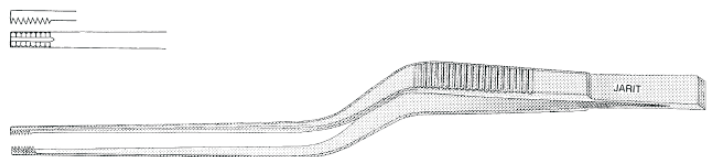

JARIT CARB-BITE TISSUE & NEEDLE FORCEPS

ADSON Needle Forceps,
1 x 2 teeth

- 122-500 4 $\frac{3}{4}$ " (12.1cm)
- 122-501 4 $\frac{3}{4}$ " (12.1cm), delicate
- 122-502 6" (15.2cm)
- 122-503 6" (15.2cm), delicate

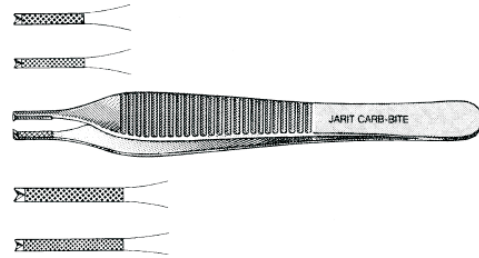

122-510 **BROWN-ADSON** Needle Forceps,
4 $\frac{3}{4}$ " (12.1cm), 3 x 4 teeth

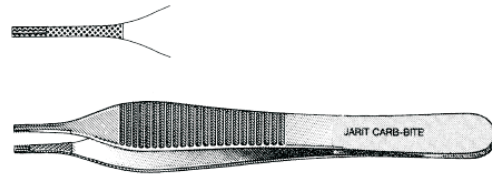

CUSHING Needle Forceps,
Gutsch handle, scraper end

- 122-530 7" (17.8cm)
- 122-535 7" (17.8cm), delicate



SEMKEN Needle Forceps,
1 x 2 teeth

- 122-590 6" (15.2cm)
- 122-591 6" (15.2cm), delicate

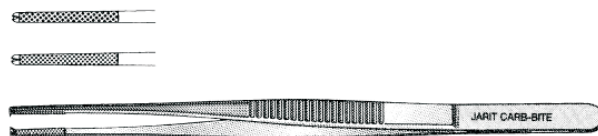

JOSEPH Saws,
7½" (19cm)

- 420-100** Bayonet blade angled left
- 420-101** Bayonet blade angled right

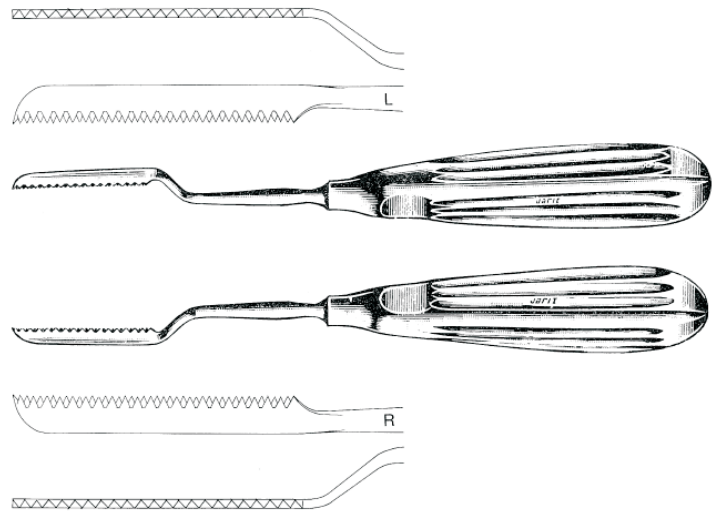

- 420-102** **JOSEPH Saw,**
6⅞" (17.5cm), straight

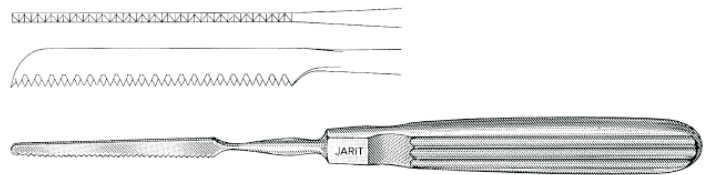

JARIT STARDUST Rasps,
7½" (19cm), 7mm x 25mm blade

- 420-110** Straight
- 420-111** Curved

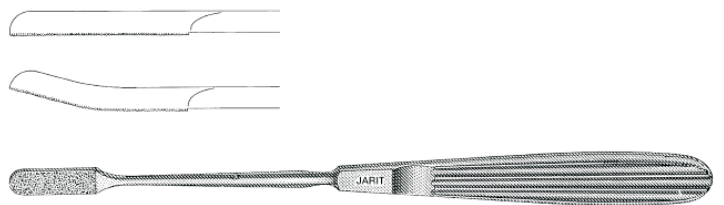

420-120 CONVERSE Rasp,
7" (17.8cm), double-ended,
fine and coarse ends, 11mm x 53mm,
cuts on down stroke

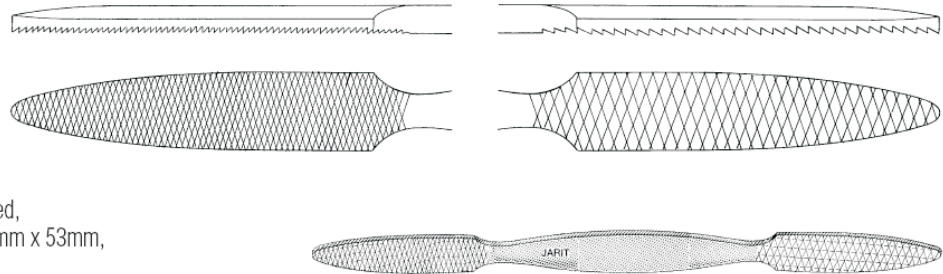

FOMON Rasps,
8½" (21.6cm), double-ended,
convex and flat sides, 7mm x 35mm,
cuts on down stroke

420-125 Fine
420-126 Coarse

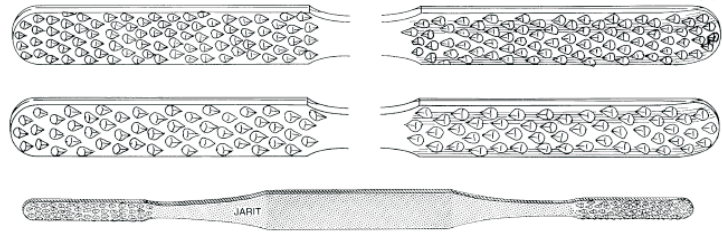

420-130 COTTLE Rasp,
8" (20.3cm), 7mm x 36mm,
cuts on down stroke

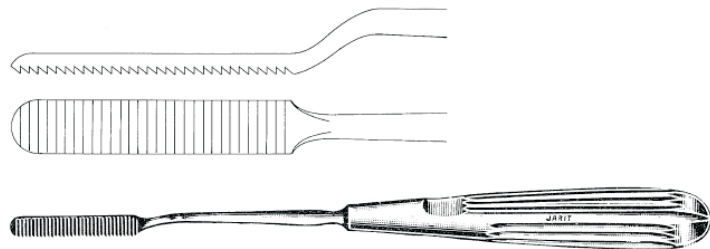

420-132 FOMON Rasp,
8½" (21.6cm), double-ended,
fine and coarse sides, 7mm x 35mm,
cuts on down stroke

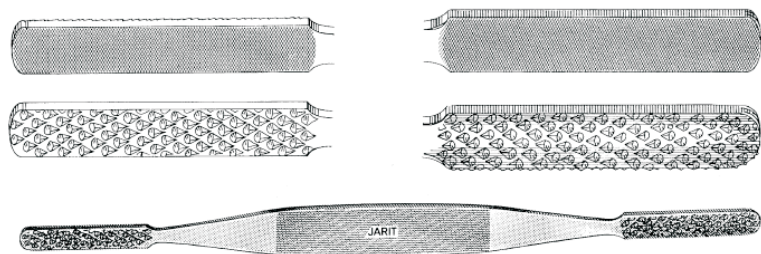

420-135 **MALTZ** Rasp,
6½" (16.5cm), 6mm x 36mm,
cuts on down stroke

420-136 **MALTZ-ANDERSON** Rasp,
6½" (16.5cm), 6mm x 36mm,
cuts on up stroke

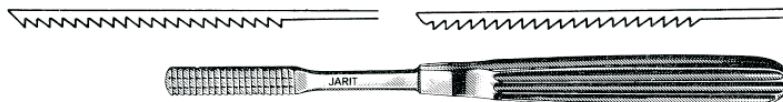

PARKES Rasps,
8" (20.3cm), 7mm x 31mm,
cuts on down stroke

420-138 20 fine concave teeth
420-139 11 extra coarse concave teeth

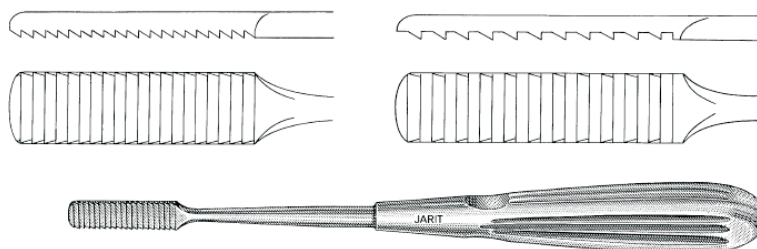

AUFRICHT Rasps,
8" (20.3cm), 8mm x 30mm

420-140 Cuts on up stroke
420-141 Cuts on down stroke

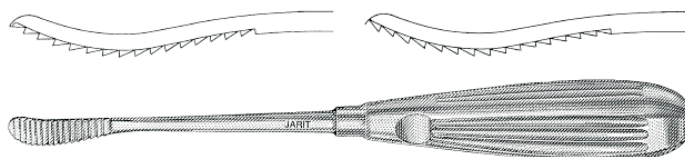

420-145 **LEWIS** Rasp,
7¼" (18.4cm), 7mm x 15mm,
cuts on down stroke

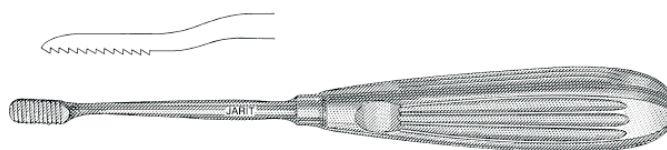

JOSEPH Rasps,
7¼" (18.4cm), 7.5mm x 40mm,
cuts on up stroke

- 420-147 Coarse teeth
- 420-148 Fine teeth

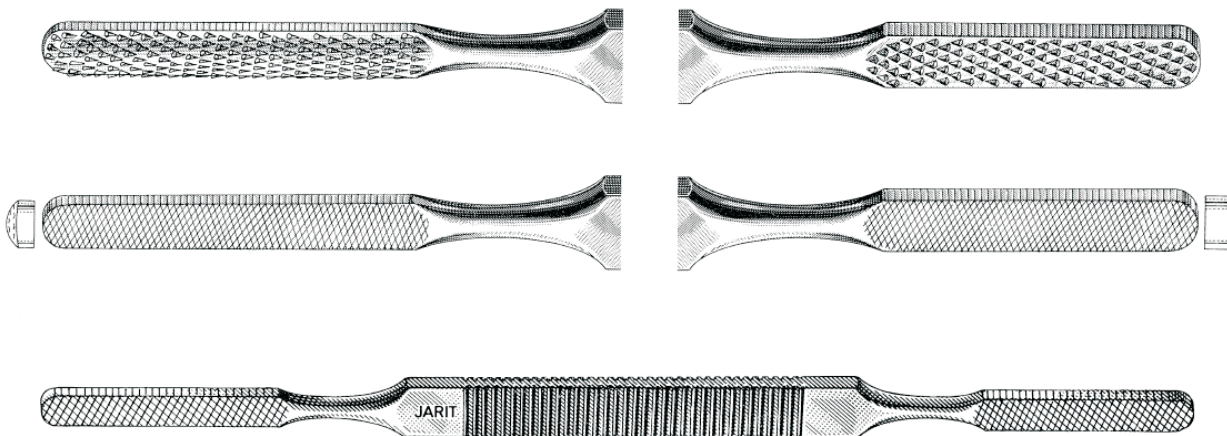
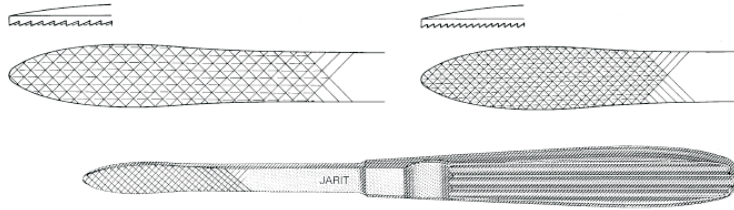

420-150 KLEINERT-KUTZ Rasp,
8¾" (22cm), double-ended,
convex coarse side and flat fine side,
7mm x 45mm, cuts on down stroke

DINGMAN Otoabradars,
6½" (15.6cm), double row of 10 fine teeth

- 420-160 Curved left
- 420-161 Curved right

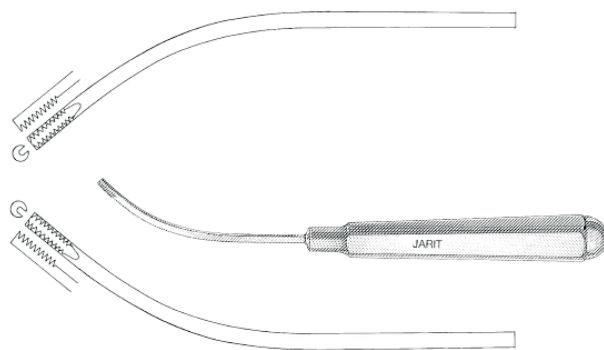

JARIT CARB-BITE Rasps,
 8¼" (21cm), double-ended,
 7mm x 40mm, cuts on down stroke



<p>420-170 No. 1: very fine grit</p>		<p>No. 2: fine grit</p>	
<p>420-171 No. 3: fine grit</p>		<p>No. 4: coarse grit</p>	
<p>420-172 No. 5: coarse grit</p>		<p>No. 6: coarse grit</p>	
<p>420-173 No. 7: coarse grit</p>		<p>No. 8: very coarse grit</p>	

JARIT CARB-BITE Rasps,
8¼" (21cm), single-ended,
7mm x 40mm, cuts on down stroke

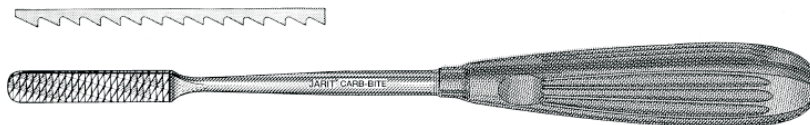

420-175 No. 1: very fine grit

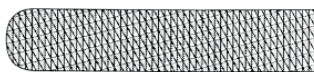

420-179 No. 5: coarse grit

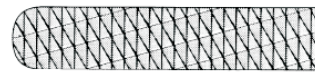

420-176 No. 2: fine grit

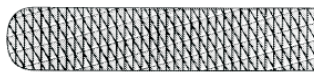

420-180 No. 6: coarse grit

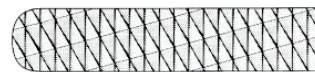

420-177 No. 3: fine grit

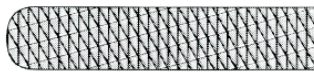

420-181 No. 7: coarse grit

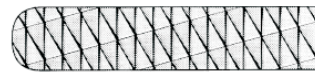

420-178 No. 4: coarse grit



420-182 No. 8: very coarse grit



420-184 **JARIT CARB-BITE Glabella Rasp,**
8¼" (21cm), 5.5mm x 10mm,
cuts on down stroke

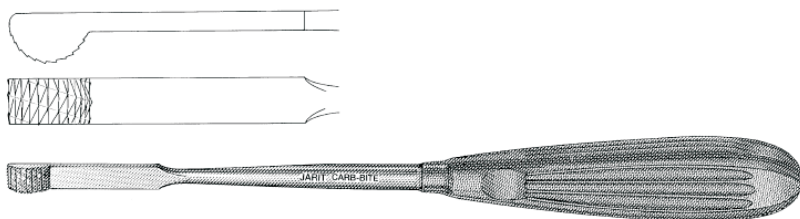

420-210 **COTTLE** Columella Clamp,
4½" (11.4cm), jaw width 11mm

