

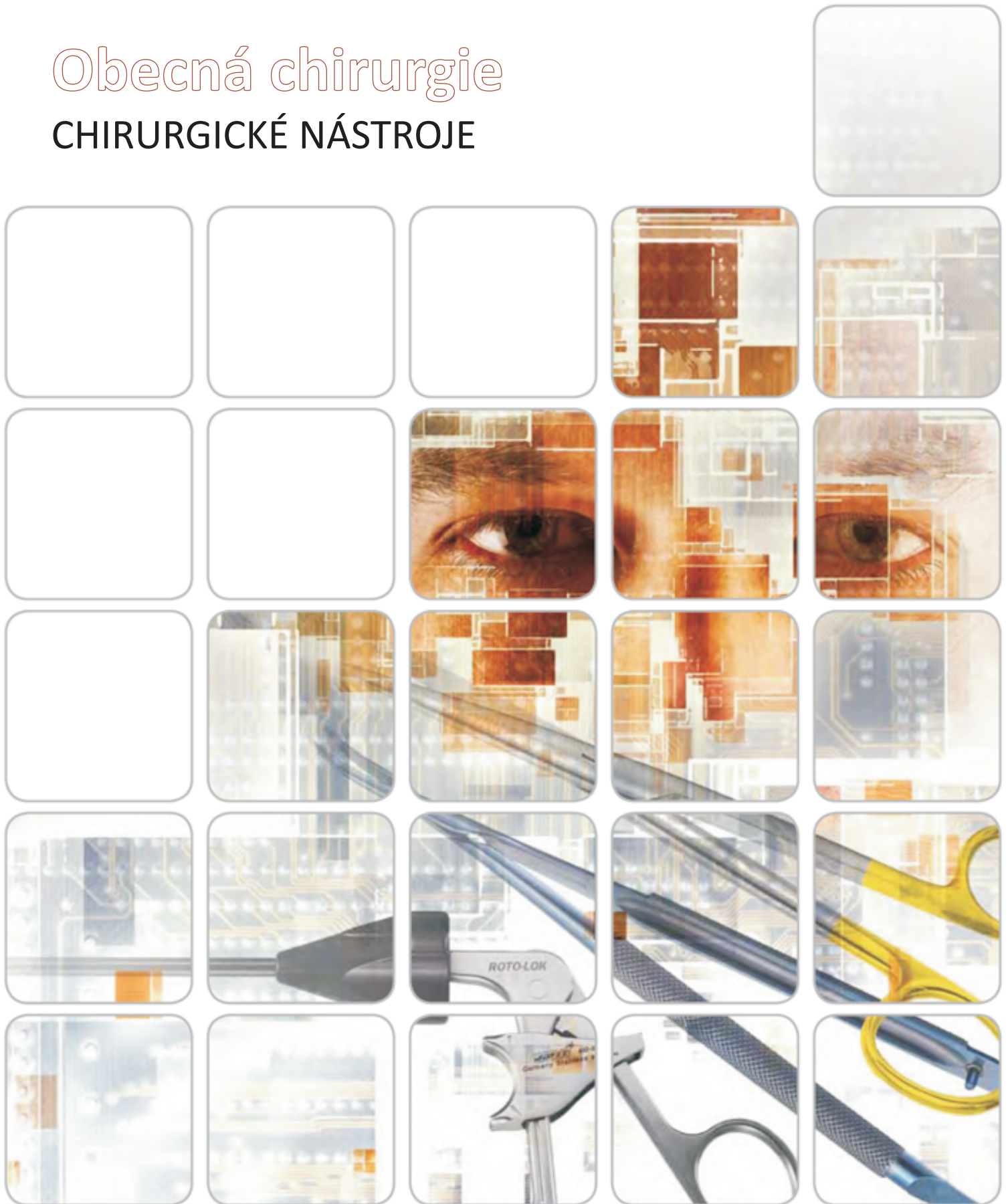

# Obecná chirurgie

## CHIRURGICKÉ NÁSTROJE





Jarit nabízí více než 30 let zkušeností na poli chirurgických nástrojů. Díky spolupráci s předními světovými výrobci vznikly unikátní chirurgické nástroje spojující v sobě americkou vynalézavost s precizností vlastní německým výrobcům.

Nástroje Jarit jsou vyrobeny z nejvyšší chirurgické oceli a splňují všechny požadavky kladené chirurgem na ergonomii a vyváženost.

Naším cílem je kompromis mezi kvalitou a cenou tak abychom uspokojili nároky kladené nemocnicemi.

Na vybrané chirurgické nástroje je poskytována tříletá záruka.

Volit můžete z široké nabídky nástrojů od běžně používaných po úzce specializované. Nástroje jsou rozděleny do několika katalogů, podle oborů.

U chirurgických nůžek, jehelců a pinzet máte na výběr až ze tří možností dle Vašich potřeb a nároků. Tyto nástroje jsou odlišeny pomocí různě barevných rukojetí.



## Záruční podmínky

Záruka na všechny nástroje Jarit se vztahuje na veškeré defekty materiálu a provedení. Jarit opraví, nebo vymění zdarma veškeré nástroje, které vykazují tyto defekty a byly užívány v souladu s doporučeními výrobce.

Všechny nástroje CARB - BITE a CARB - EDGE mají navíc záruku 3 roky. Pokud se během této doby vyskytnou jakékoli problémy, CARB - EDGE nůžky budou zdarma nabroušeny a CARB - BITE jehelce budou vyměněny.

Všechny JARIT SUPERCAT nůžky mají navíc záruku jeden rok. Pokud bude potřeba provést naostření bude toto v záruční lhůtě provedeno zdarma. Po uplynutí záruční lhůty bude nabroušení provedeno za poplatek.

**OPERATING** Scissors,  
straight, sharp-sharp

Mirror Matte

<b>100-105</b>		4½" (11.4cm)
<b>100-109</b>		5" (12.7cm)
<b>100-110</b>	<b>099-110</b>	5½" (14cm)
<b>100-111</b>		6½" (16.5cm)

**OPERATING** Scissors,  
curved, sharp-sharp

Mirror

<b>100-115</b>	4½" (11.4cm)
<b>100-117</b>	5" (12.7cm)
<b>100-120</b>	5½" (14cm)
<b>100-122</b>	6½" (16.5cm)

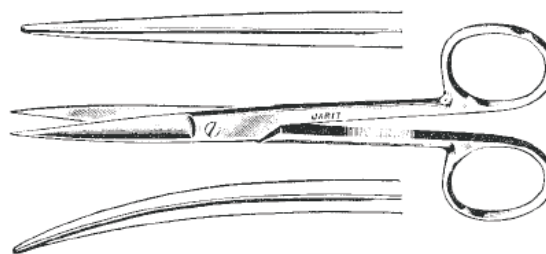

**OPERATING** Scissors,  
straight, sharp-blunt

Mirror Matte

<b>100-125</b>		4½" (11.4cm)
<b>100-127</b>		5" (12.7cm)
<b>100-130</b>	<b>099-130</b>	5½" (14cm)
<b>100-132</b>		6½" (16.5cm)

**OPERATING** Scissors,  
curved, sharp-blunt

Mirror

<b>100-116</b>	4½" (11.4cm)
<b>100-134</b>	5" (12.7cm)
<b>100-135</b>	5½" (14cm)
<b>100-137</b>	6½" (16.5cm)

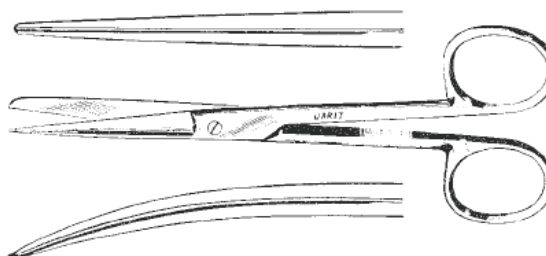



**OPERATING** Scissors,  
straight, blunt-blunt

- 100-126 4½" (11.4cm)
- 100-129 5" (12.7cm)
- 100-131 5½" (14cm)
- 100-138 6½" (16.5cm)

**OPERATING** Scissors,  
curved, blunt-blunt

- 100-128 4½" (11.4cm)
- 100-133 5" (12.7cm)
- 100-136 5½" (14cm)
- 100-139 6½" (16.5cm)

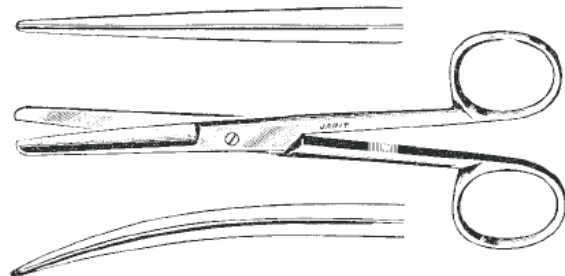

- 100-140 **OPERATING** Scissors,  
5½" (14cm), straight,  
sharp-blunt, one blade serrated

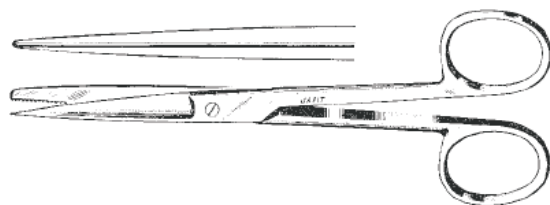

**DEAVER** Scissors,  
sharp-sharp

**100-175** 5½" (14cm), straight

**100-180** 5½" (14cm), curved

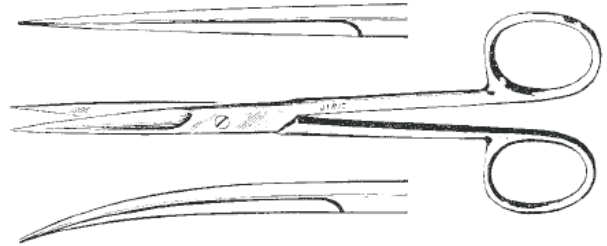

**DEAVER** Scissors,  
sharp-blunt

**100-185** 5½" (14cm), straight

**100-190** 5½" (14cm), curved

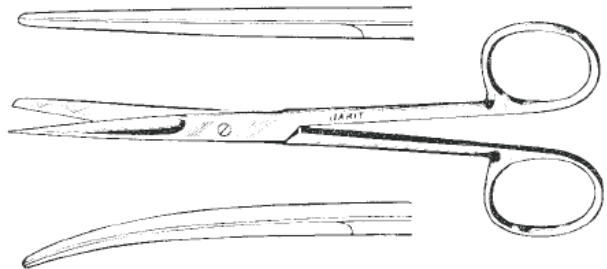

**100-195** **SISTRUNK** Scissors,  
5½" (13cm), slightly curved

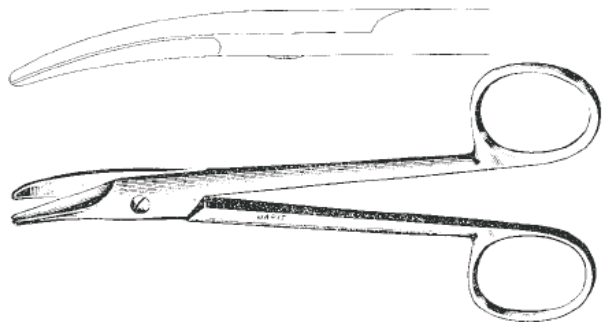

**JARIT** OPERATING SCISSORS

**MAYO** Scissors,  
beveled blades

Mirror

Matte

- 100-200 099-200 5½" (14cm), straight
- 100-202 099-202 5½" (14cm), curved
- 100-210 099-210 6¾" (17.1cm), straight
- 100-212 099-212 6¾" (17.1cm), curved

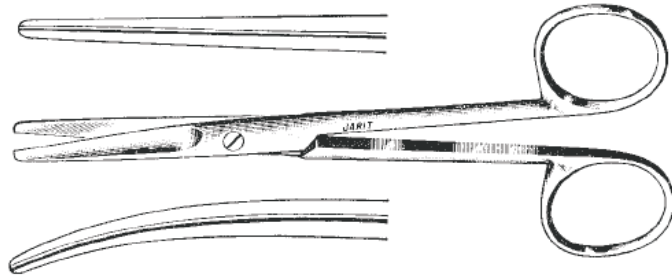

**MAYO** Scissors,  
round blades

- 100-215 5½" (14cm), straight
- 100-217 5½" (14cm), curved
- 100-220 6¾" (17.1cm), straight
- 100-222 6¾" (17.1cm), curved

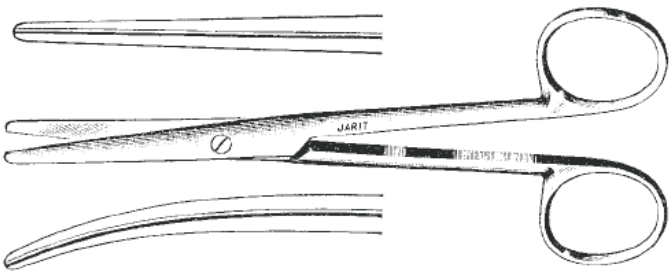

**MAYO-NOBLE** Dissecting Scissors,  
beveled blades, 6½" (16.5cm)

- 100-224 Straight
- 100-225 Curved

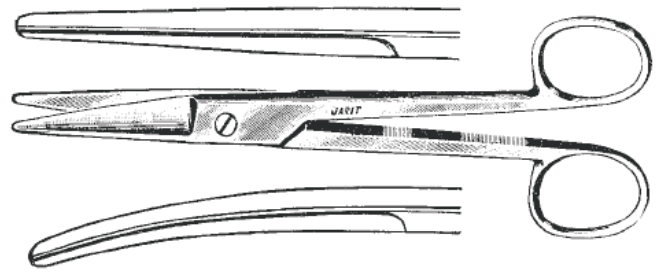

**MAYO-NOBLE** Dissecting Scissors,  
round blades, 6½" (16.5cm)

- 100-226 Straight
- 100-227 Curved

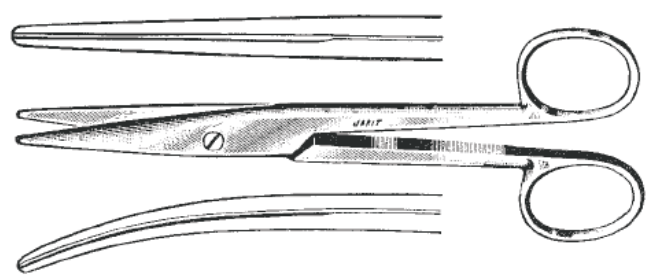

**DOYEN** Abdominal Scissors,  
7" (17.8cm)

- 100-230 Straight
- 100-231 Curved

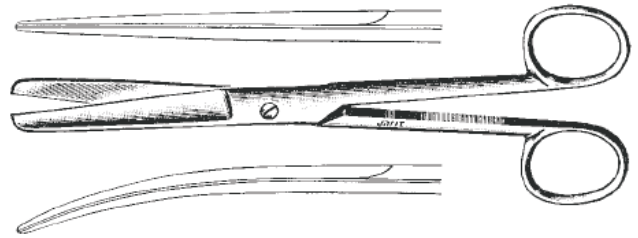

**100-233 FERGUSON** Abdominal Scissors,  
7" (17.8cm), angled on flat

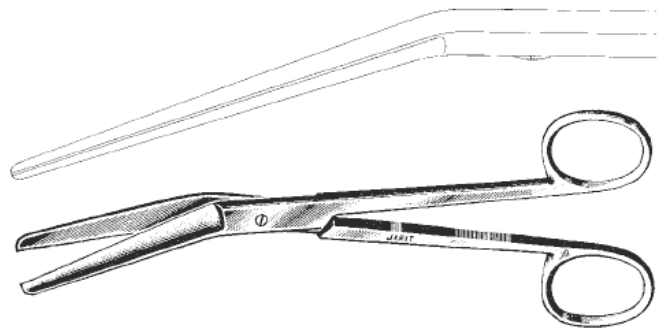

**METZENBAUM (LAHEY)** Scissors,  
5 3/4" (14.6cm)

- Mirror Matte
- 100-250 099-250 Straight
- 100-251 099-251 Curved

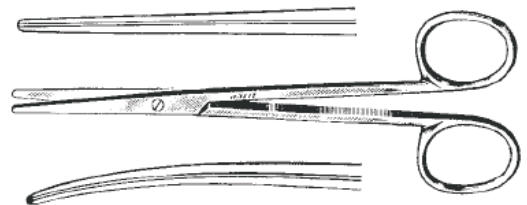

**METZENBAUM** Scissors,  
straight

Mirror

100-260 7" (17.8cm)

100-265 8" (20.3cm)

**METZENBAUM** Scissors,  
curved

Mirror Matte

100-261 7" (17.8cm), slender, delicate

100-262 099-262 7" (17.8cm)

100-266 8" (20.3cm)

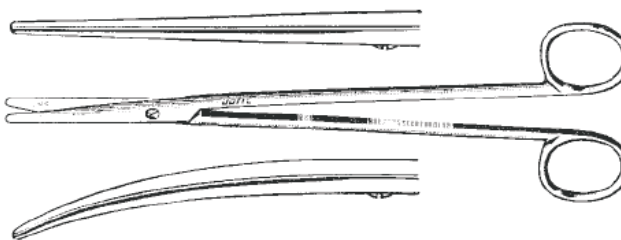

**JARIT** Scissors,  
5 1/2" (13.5cm), delicate, dissecting tips

100-269 Straight

100-270 Curved

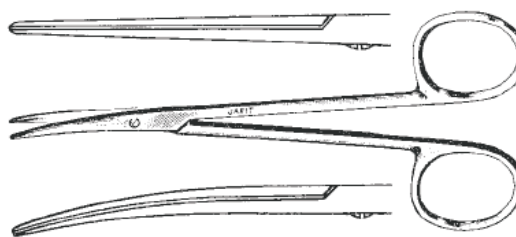

100-272 **METZENBAUM (LAHEY)** Scissors,  
5 1/2" (14.6cm), curved, delicate

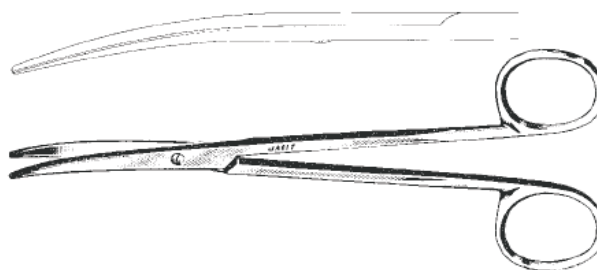

**JARIT** OPERATING SCISSORS

**JOSEPH** Scissors

- 100-278 5¼" (14.6cm), straight
- 100-279 5¼" (14.6cm), curved

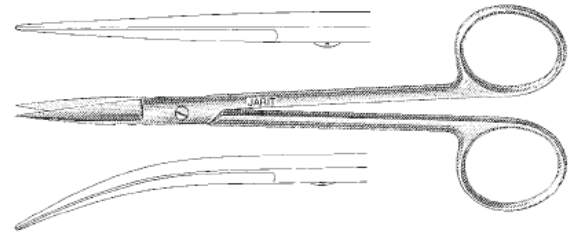

**KELLY** Fistula Scissors

- 100-280 6¼" (16cm), straight
- 100-281 6¼" (16cm), curved

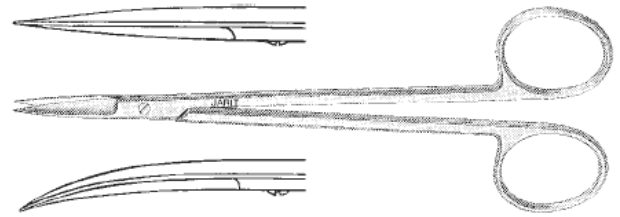

**JARIT** Flat Tip Scissors,  
curved

- 100-290 5" (12.7cm)
- 100-291 7" (17.8cm)
- 100-292 9" (22.8cm)

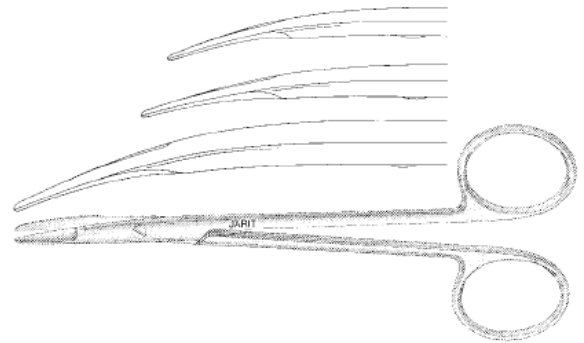

**REYNOLDS** Scissors,  
narrow tip, curved

- 100-295 5½" (14cm), plain edge
- 100-296 5½" (14cm), serrated edge
- 100-297 7" (17.8cm), plain edge
- 100-298 7" (17.8cm), serrated edge

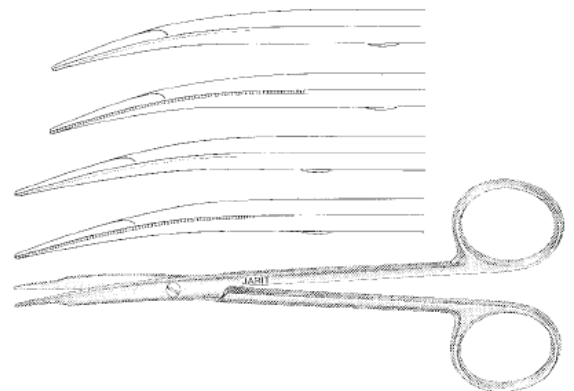

**JART** OPERATING SCISSORS

**JAMISON-METZENBAUM** Scissors,  
narrow tip, curved

- 100-300 6" (15.2cm)
- 100-302 7" (17.8cm)
- 100-304 8" (20.3cm)
- 100-306 9" (22.8cm)

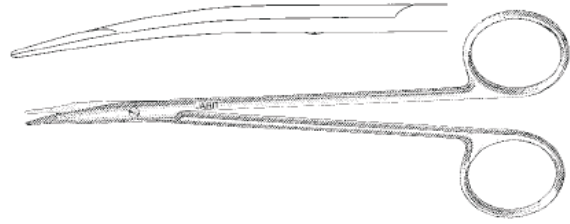

**PLASTIC SURGERY** Scissors,  
sharp-blunt

- 100-320 4 3/4" (12.1cm), straight
- 100-322 4 3/4" (12.1cm), curved

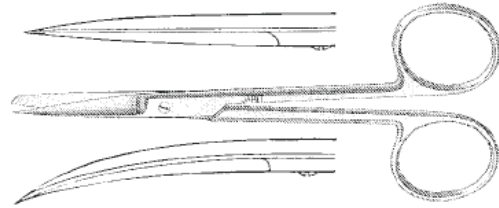

**PLASTIC SURGERY** Scissors,  
sharp-sharp

- 100-325 4 3/4" (12.1cm), straight
- 100-327 4 3/4" (12.1cm), curved

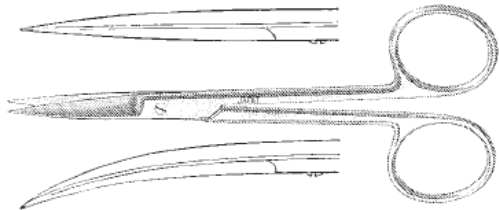

**PLASTIC SURGERY** Scissors,  
blunt-blunt

- 100-330 4 3/4" (12.1cm), straight
- 100-332 4 3/4" (12.1cm), curved

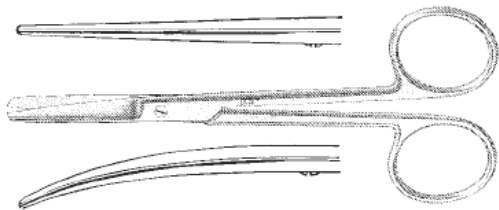



**JARIT** BANDAGE SCISSORS

**LISTER** Bandage Scissors

Mirror	Matte	
100-502		3½" (8.9cm)
100-512		4½" (11.4cm)
100-522	099-522	5½" (14cm)
100-526	099-526	7¼" (18.4cm)
100-528	099-528	8" (20.3cm)



100-527 **LISTER** Bandage Scissors, one large ring  
7½" (19.1cm)

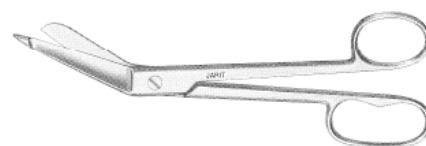

100-530 **KNOWLES** Finger Bandage Scissors,  
5¾" (14.6cm)

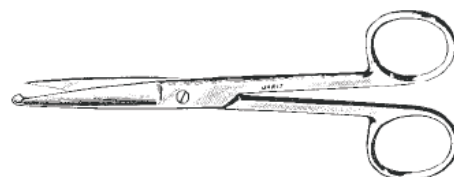

100-531 **KNOWLES** Finger Bandage Scissors,  
5½" (14cm), side curved

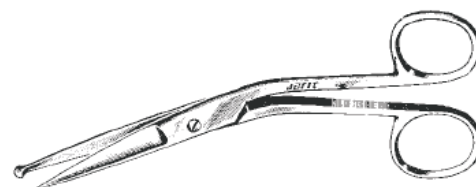

100-532 One blade serrated

**JARIT** Utility Shears,  
one serrated blade,  
stainless steel with autoclavable plastic finger rings

100-539	5½" (14cm), Black	100-544	7" (17.8cm), Purple
100-540	7" (17.8cm), Black	100-545	7" (17.8cm), Green
100-541	7" (17.8cm), Red	100-546	7" (17.8cm), Yellow
100-542	7" (17.8cm), Orange		
100-543	7" (17.8cm), Blue		

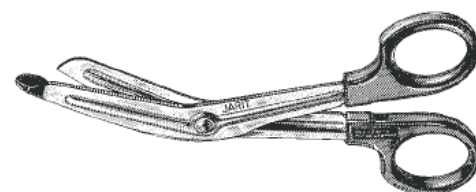

## JARIT CARB-EDGE SCISSORS

These superbly crafted instruments have solid inserts of a hard, tough alloy permanently welded to the scissors, and are vacuum hardened. This alloy, composed principally of tungsten, cobalt, chromium and carbon, is harder than stainless steel (61 to 65 Rockwell C). Cutting edges of JARIT CARB-EDGE Scissors stay sharp longer than those of ordinary scissors because of the high transfer rupture strength of the blade

inserts. The material is also highly resistant to corrosion, further prolonging its useful life.

JARIT CARB-EDGE Scissors are guaranteed to stay sharp for at least three years of normal usage. If sharpening should be required during the guarantee period, it will be done without charge. Finger rings are gold plated for easy identification.



## JARIT CARB-EDGE SCISSORS

These superbly crafted instruments have solid inserts of a hard, tough alloy permanently welded to the scissors, and are vacuum hardened. This alloy, composed principally of tungsten, cobalt, chromium and carbon, is harder than stainless steel (61 to 65 Rockwell C). Cutting edges of JARIT CARB-EDGE Scissors stay sharp longer than those of ordinary scissors because of the high transfer rupture strength of the blade

inserts. The material is also highly resistant to corrosion, further prolonging its useful life.

JARIT CARB-EDGE Scissors are guaranteed to stay sharp for at least three years of normal usage. If sharpening should be required during the guarantee period, it will be done without charge. Finger rings are gold plated for easy identification.

### OPERATING Scissors, 5¾" (14.6cm)

- 101-110 Straight, sharp-sharp
- 101-112 Curved, sharp-sharp
- 101-130 Straight, sharp-blunt
- 101-132 Curved, sharp-blunt

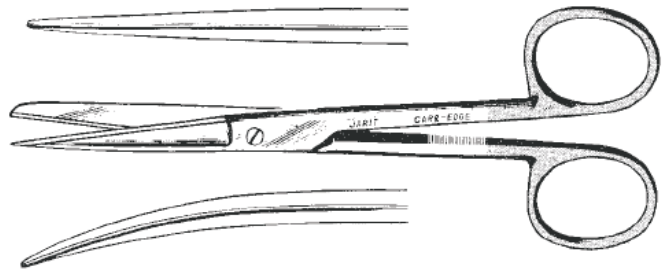

### MAYO Scissors

- | Satin   | Matte   |   |
|---------|---------|---|
| 101-215 |         | 6" (15.2cm), straight                     |
| 101-217 |         | 6" (15.2cm), curved                       |
| 101-218 |         | 6¼" (15.9cm), straight, slender, fine tip |
| 101-219 |         | 6¼" (15.9cm), curved, slender, fine tip   |
| 101-220 | 103-220 | 6¾" (17.1cm), straight                    |
| 101-222 | 103-222 | 6¾" (17.1cm), curved                      |
| 101-230 |         | 14" (35.6cm), straight                    |
| 101-232 |         | 14" (35.6cm), curved                      |

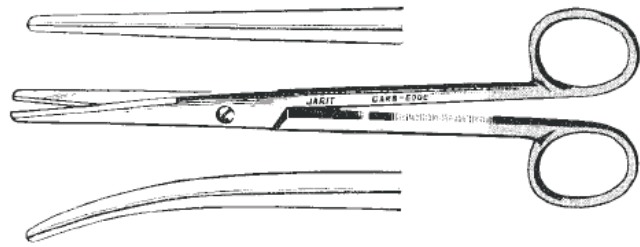

### MAYO-HARRINGTON Scissors

- 101-225 9" (22.8cm), straight
- 101-226 9" (22.8cm), curved

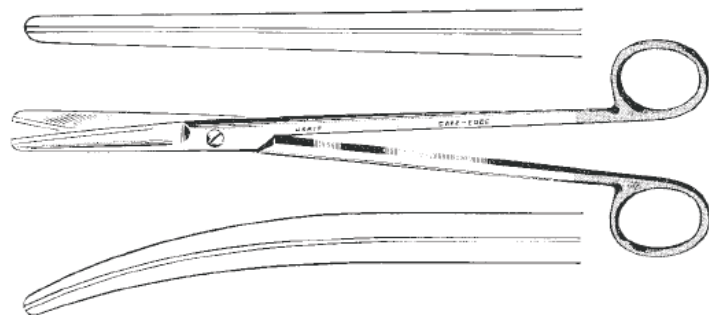

## JARIT CARB-EDGE SCISSORS

These superbly crafted instruments have solid inserts of a hard, tough alloy permanently welded to the scissors, and are vacuum hardened. This alloy, composed principally of tungsten, cobalt, chromium and carbon, is harder than stainless steel (61 to 65 Rockwell C). Cutting edges of JARIT CARB-EDGE Scissors stay sharp longer than those of ordinary scissors because of the high transfer rupture strength of the blade

inserts. The material is also highly resistant to corrosion, further prolonging its useful life.

JARIT CARB-EDGE Scissors are guaranteed to stay sharp for at least three years of normal usage. If sharpening should be required during the guarantee period, it will be done without charge. Finger rings are gold plated for easy identification.

**METZENBAUM (LAHEY) Scissors,**  
5 $\frac{1}{4}$ " (14.6cm), delicate

Satin     Matte

101-250    103-250    Straight

101-251    103-251    Curved



**METZENBAUM (LAHEY) Scissors,**  
5 $\frac{1}{4}$ " (14.6cm), delicate, sharp-sharp

101-252    Straight

101-253    Curved

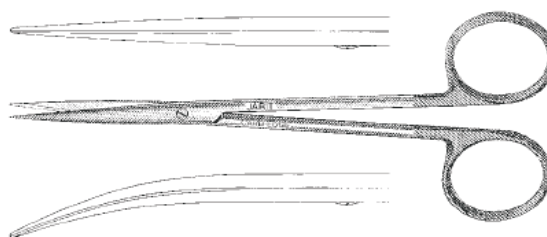

101-255    **PETIT-POINT REYNOLDS Scissors,**  
5" (12.7cm), curved, one blade serrated

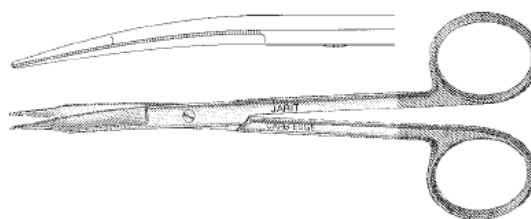

## JARIT<sup>®</sup> CARB-EDGE SCISSORS

These superbly crafted instruments have solid inserts of a hard, tough alloy permanently welded to the scissors, and are vacuum hardened. This alloy, composed principally of tungsten, cobalt, chromium and carbon, is harder than stainless steel (61 to 65 Rockwell C). Cutting edges of JARIT CARB-EDGE Scissors stay sharp longer than those of ordinary scissors because of the high transfer rupture strength of the blade

inserts. The material is also highly resistant to corrosion, further prolonging its useful life.

JARIT CARB-EDGE Scissors are guaranteed to stay sharp for at least three years of normal usage. If sharpening should be required during the guarantee period, it will be done without charge. Finger rings are gold plated for easy identification.

### METZENBAUM Scissors

Satin	Matte	
101-258	103-258	7" (17.8cm), curved
101-260		7" (17.8cm), delicate, straight
101-261	103-261	7" (17.8cm), delicate, curved
101-265		8" (20.3cm), curved

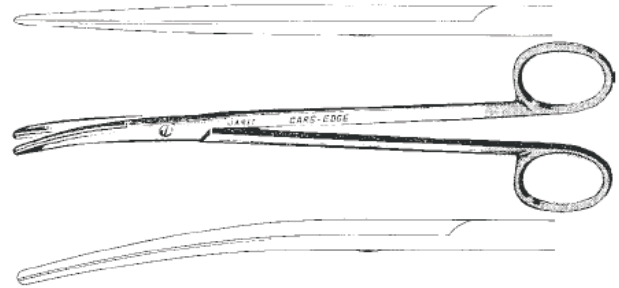

### METZENBAUM (NELSON) Scissors

101-266	9" (22.8cm), straight
101-267	9" (22.8cm), curved
101-275	9" (22.8cm), straight, delicate
101-276	9" (22.8cm), curved, delicate
101-269	10" (25.4cm), curved
101-270	11" (28cm), curved
101-272	12" (30.5cm), curved
101-256	14" (35.6cm), curved

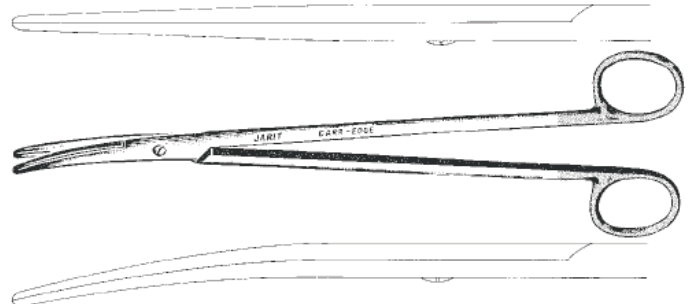

### METZENBAUM Scissors, sharp-sharp

101-257	7" (17.8cm), straight
101-259	7" (17.8cm), delicate, curved
101-278	9" (22.8cm), straight
101-279	9" (22.8cm), curved

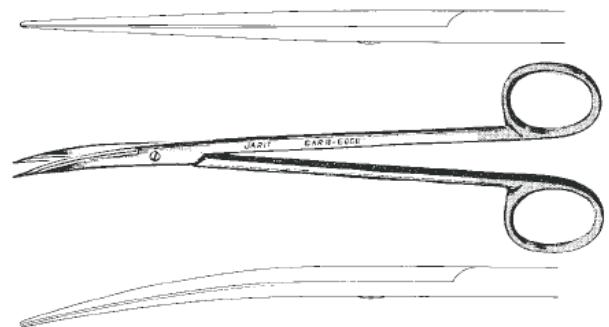

## JARIT CARB-EDGE SCISSORS

These superbly crafted instruments have solid inserts of a hard, tough alloy permanently welded to the scissors, and are vacuum hardened. This alloy, composed principally of tungsten, cobalt, chromium and carbon, is harder than stainless steel (61 to 65 Rockwell C). Cutting edges of JARIT CARB-EDGE Scissors stay sharp longer than those of ordinary scissors because of the high transfer rupture strength of the blade

inserts. The material is also highly resistant to corrosion, further prolonging its useful life.

JARIT CARB-EDGE Scissors are guaranteed to stay sharp for at least three years of normal usage. If sharpening should be required during the guarantee period, it will be done without charge. Finger rings are gold plated for easy identification.

**IRIS** Scissors,  
4½" (11.4cm)

- 101-300 Straight
- 101-301 Curved

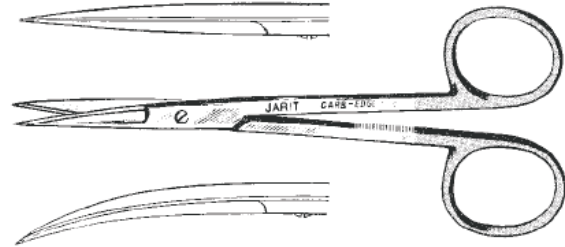

**STRABISMUS** Scissors,  
4½" (11.4cm)

- 101-310 Straight
- 101-311 Curved

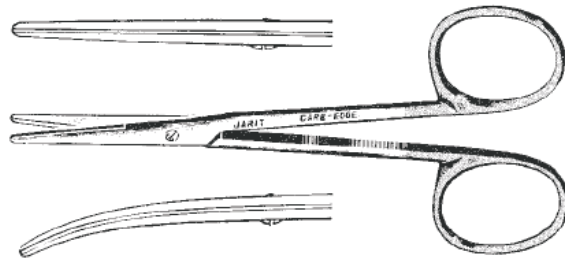

- 101-350 **WIRE** Suture Scissors,  
4¾" (12.1cm), angled, for cutting suture and  
wire (26 gauge and smaller)

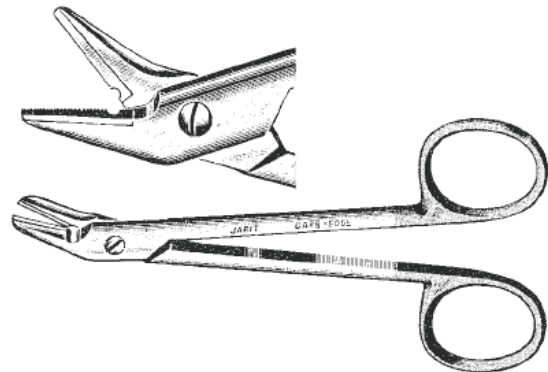



## JARIT SUPERCUT SCISSORS

Developed by utilizing unique and innovative methods of grinding, sharpening and heat treating, JARIT SUPERCUT scissors have achieved a degree of sharpness greater than on conventional surgical scissors. In the surgeon's hand, the "feel" of the cutting motion is so smooth it creates a sensation of absolute control. Laboratory tests simulating

hundreds of surgical procedures, confirmed that JARIT SUPERCUT scissors retain their sharpness long after conventional scissors become dull. JARIT backs this claim with a *Date-Stamped Certified Warranty*. Finger rings are black plated for easy identification.

The JARIT SUPERCUT blade is razor sharp and glides effortlessly through tissue with a clean precise cut. The finely serrated lower blade helps prevent slippage.

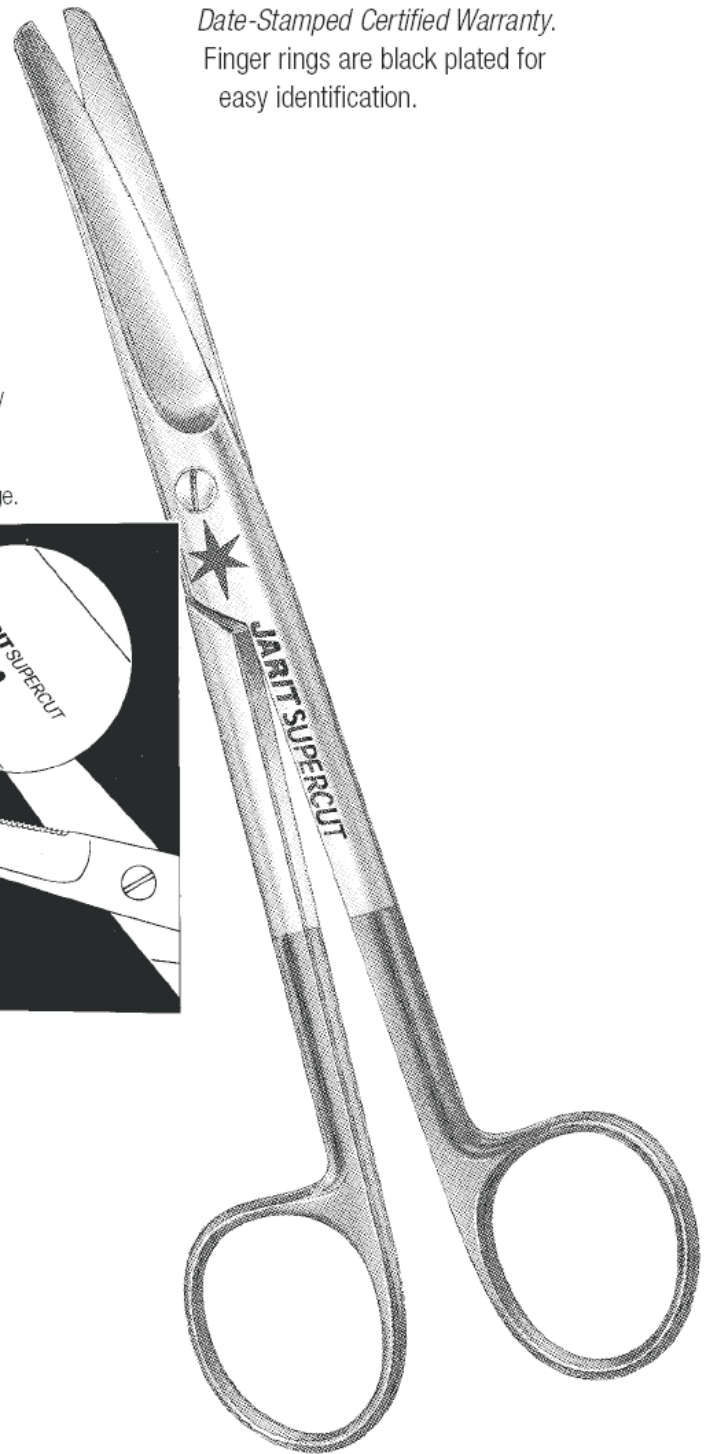
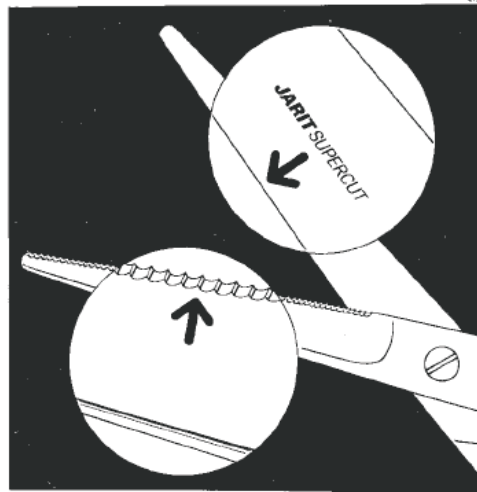



**JARIT® SUPERCUT SCISSORS - GENERAL SURGERY**



**MAYO Scissors**

- 102-100 5½" (14cm), straight
- 102-102 5½" (14cm), curved
- 102-110 6¾" (17.1cm), straight
- 102-112 6¾" (17.1cm), curved

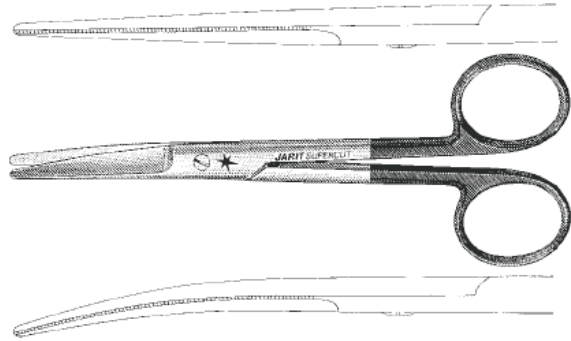

**MAYO Scissors**

- 102-115 9" (22.8cm), straight
- 102-116 9" (22.8cm), curved
- 102-118 11" (28cm), curved
- 102-113 10" (25.4cm), straight
- 102-114 12" (30.5cm), straight

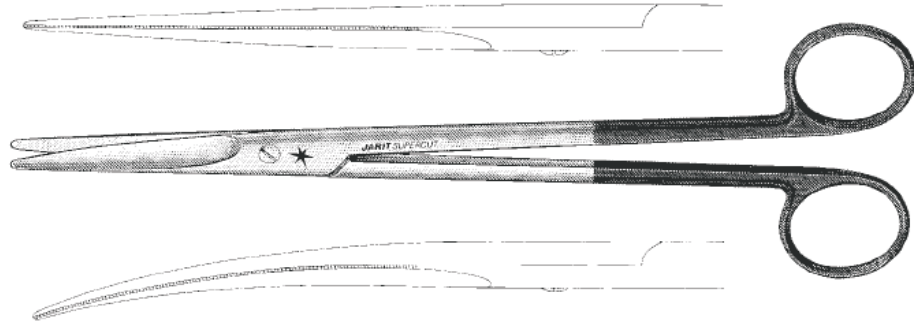

**METZENBAUM (LAHEY) Scissors,**  
5¾" (14.6cm)

- 102-119 Straight
- 102-120 Curved

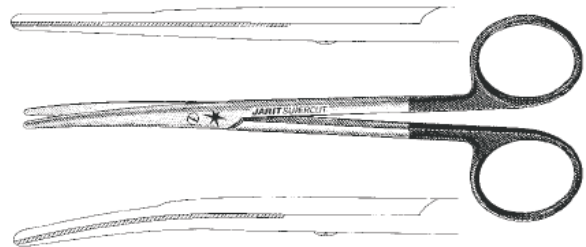

**METZENBAUM Scissors**

- 102-122 7" (17.8cm), curved
- 102-125 9" (22.8cm), curved
- 102-128 11" (28cm), curved
- 102-127 14" (35.6cm), curved
- 102-126 10" (25.4cm), curved
- 102-129 12" (30.5cm), curved

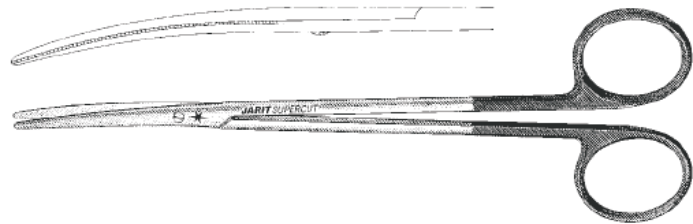

**IRIS Scissors,**  
4½" (11.4cm)

- 102-130 Straight
- 102-131 Curved

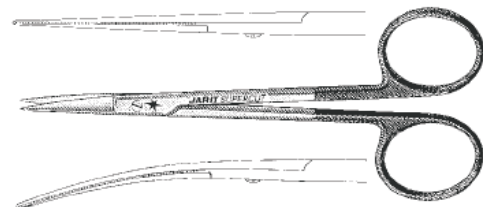

**JARIT** SUPERCUT SCISSORS - PLASTIC AND RECONSTRUCTIVE



**102-180 KNIGHT** Nasal Scissors,  
6 $\frac{3}{4}$ " (17.1cm)

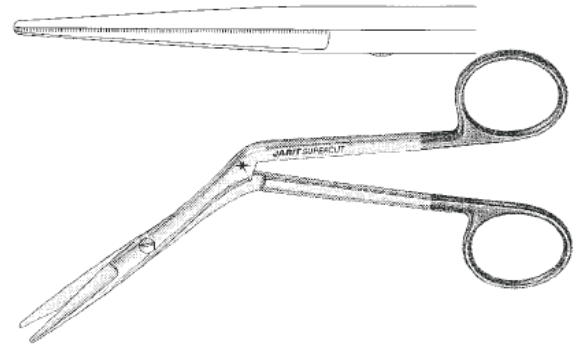

**PLASTIC SURGERY** Scissors,  
4 $\frac{3}{4}$ " (12.1cm)

- 102-200** Straight
- 102-202** Curved

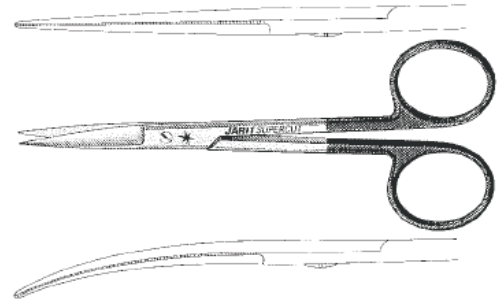

**STEVENS** Tenotomy Scissors,  
blunt tips

- |                |                |   |
|----------------|----------------|---|
| Standard       | Supercut       |   |
| <b>360-138</b> | <b>102-138</b> | 4 $\frac{1}{2}$ " (11.4cm), 13mm blades, straight, slender pattern  |
| <b>360-139</b> | <b>102-139</b> | 4 $\frac{1}{2}$ " (11.4cm), 13mm blades, curved, slender pattern    |
| <b>360-140</b> | <b>102-140</b> | 4 $\frac{1}{8}$ " (10.5cm), 12mm blades, straight, standard pattern |
| <b>360-141</b> | <b>102-141</b> | 4 $\frac{1}{8}$ " (10.5cm), 12mm blades, curved, standard pattern   |

Standard shown below. Supercut available.

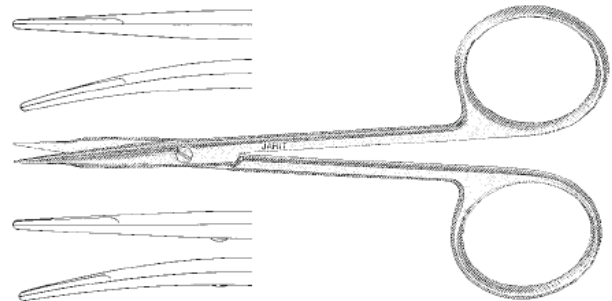

**102-205 CASTANARES** Face Lift Scissors,  
6 $\frac{1}{4}$ " (16cm), straight

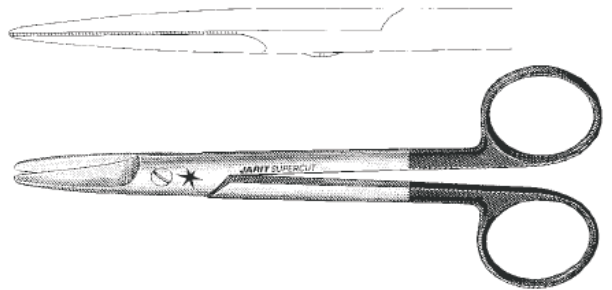

**GORNEY** Plastic Surgery Scissors,  
7 $\frac{1}{4}$ " (18.4cm)

- 102-210** Straight
- 102-211** Curved

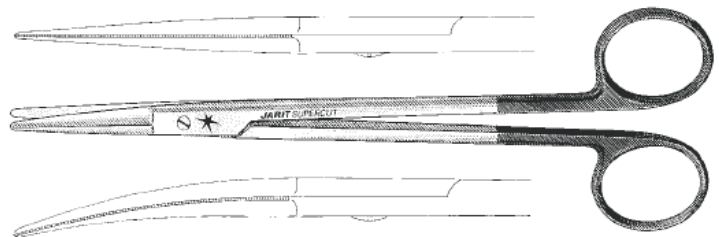

**JARIT** SUPERCUT SCISSORS - PLASTIC AND RECONSTRUCTIVE



**KAYE** Face Lift Scissors,  
beveled blades have semi-sharp  
outer edges

- 102-215 6" (15.2cm), curved
- 102-216 7½" (19cm), curved

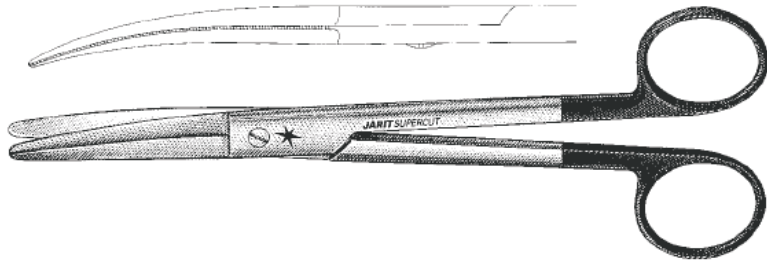

**FREEMAN-GORNEY** Face Lift Scissors,  
7½" (19cm), beveled blades have semi-sharp  
outer edges and flat, tapered tips; flared shanks  
for greater comfort and control

- 102-220 Straight
- 102-221 Curved

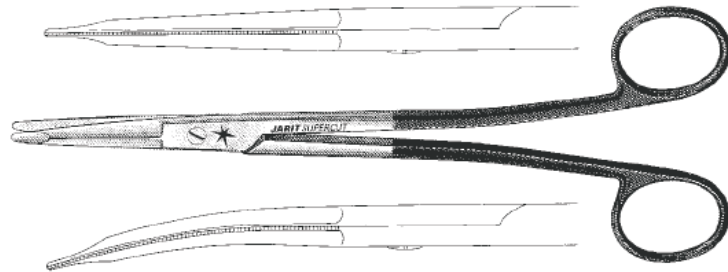

**FREEMAN-KAYE** Face Lift Scissors,  
7" (17.8cm), beveled blades have semi-sharp  
outer edges and flat, tapered tips; flared shanks  
for greater comfort and control.

- 102-225 Straight
- 102-226 Curved

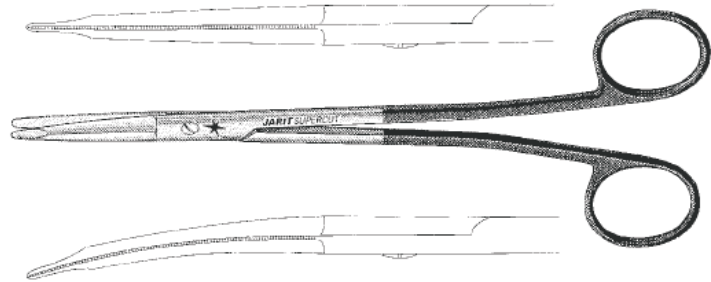

**FREEMAN** Rhytidectomy Scissors,  
7" (17.8cm), curved with flat tips;  
flared shanks for greater comfort and control.

- 102-229

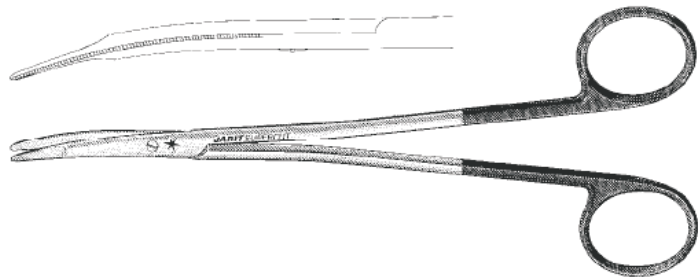

**GORNEY** Platysma Scissors,  
9" (22.8cm), beveled blades  
have semi-sharp outer edges  
and flat, tapered tips; flared shanks  
for greater comfort and control.

- 102-230 Straight
- 102-231 Curved

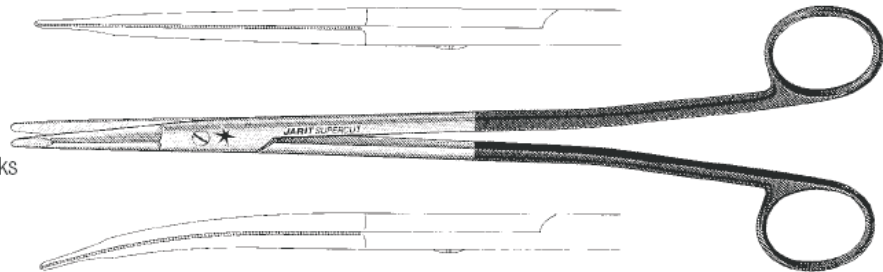

**JARIT<sup>®</sup> SUPERCUT SCISSORS - PLASTIC AND RECONSTRUCTIVE**



**102-235 FOMON Lateral Scissors,**  
5" (12.7cm), full curved

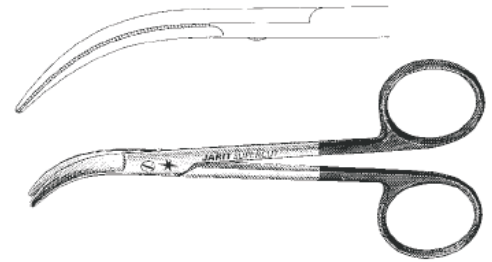

**102-236 FOMON Dorsal Scissors,**  
5 3/4" (14.6cm), angled on flat

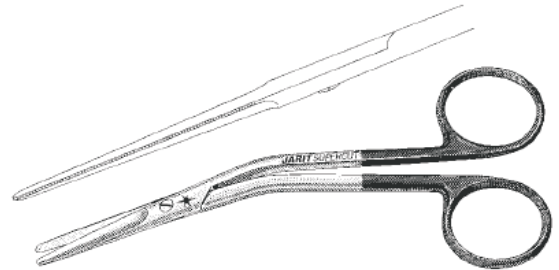

**102-238 COTTLE Dorsal Scissors,**  
6 1/2" (16.5cm), angled on flat

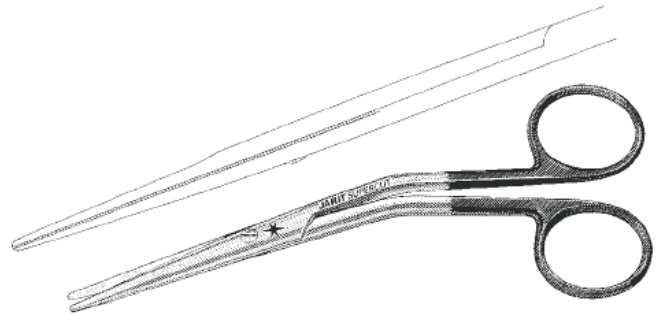

**JARIT PLASTIC AND RECONSTRUCTIVE Scissors,**  
curved

**102-240** 4 1/2" (11.4cm)

**102-242** 5 3/4" (14.6cm)

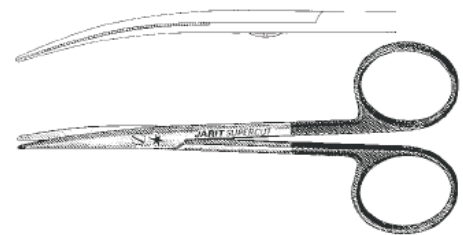

**102-245 JARIT PETIT-POINT REYNOLDS Scissors,**  
5" (12.7cm), curved

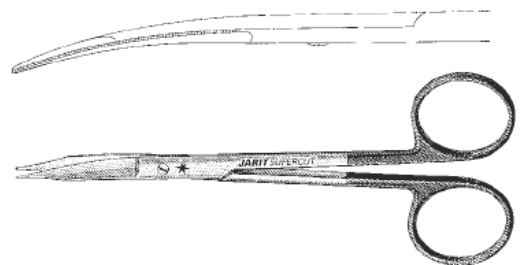

# JARIT<sup>®</sup> SUPERCUT SCISSORS - CARDIOVASCULAR

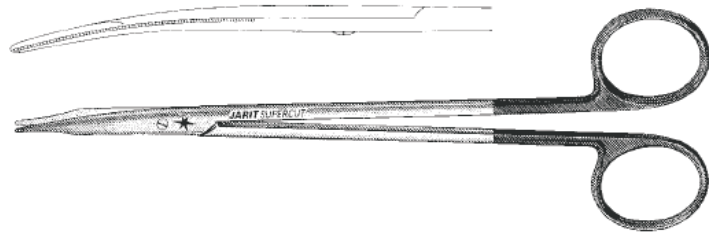

**JAMISON** Scissors,  
curved

102-300 5½" (14cm)

102-302 7" (17.8cm)

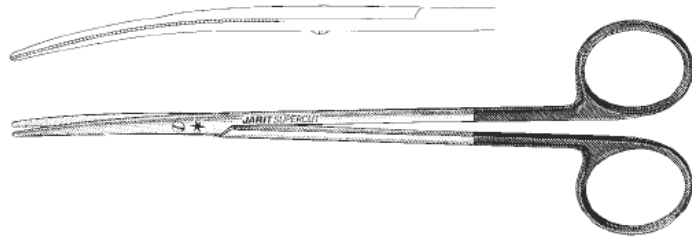

**102-310 METZENBAUM** Scissors,  
7" (17.8cm) curved, delicate

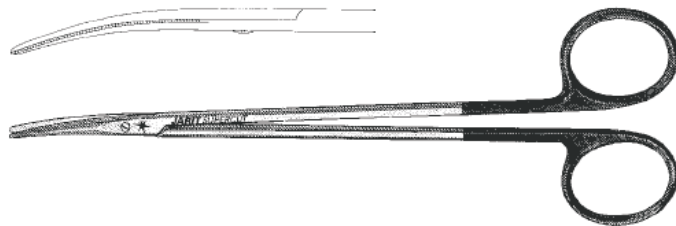

**102-315 JARIT** Endarterectomy Scissors,  
6¾" (17.1cm), curved

**JARIT** SUPERCUT SCISSORS - CARDIOVASCULAR

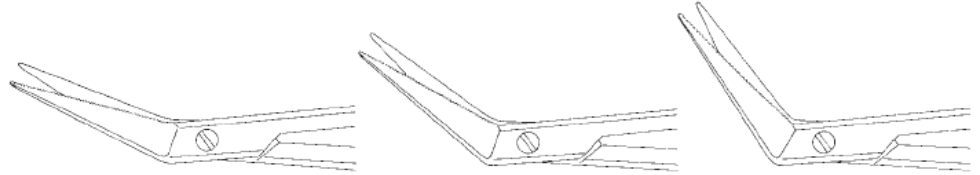

**POTTS-SMITH** Scissors,  
7" (17.8cm)

- 102-320 25°
- 102-321 45°
- 102-322 60°

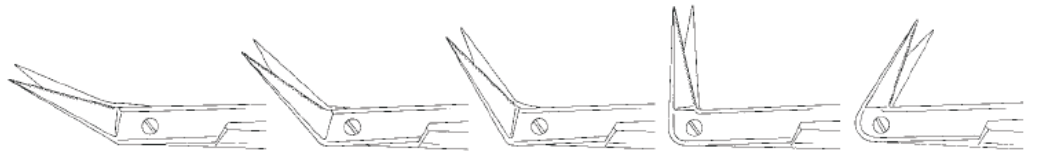
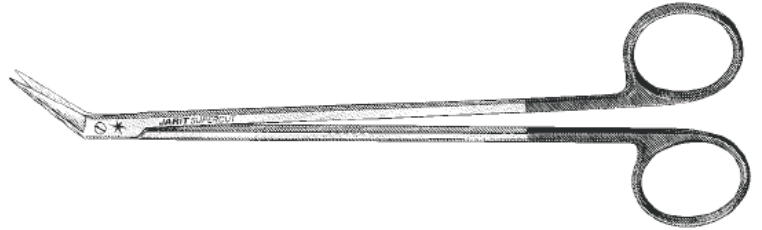

**DIETHRICH** Coronary Artery Scissors,  
7" (17.8cm)

- 102-350 25°
- 102-351 45°
- 102-352 60°
- 102-353 90°
- 102-354 125°

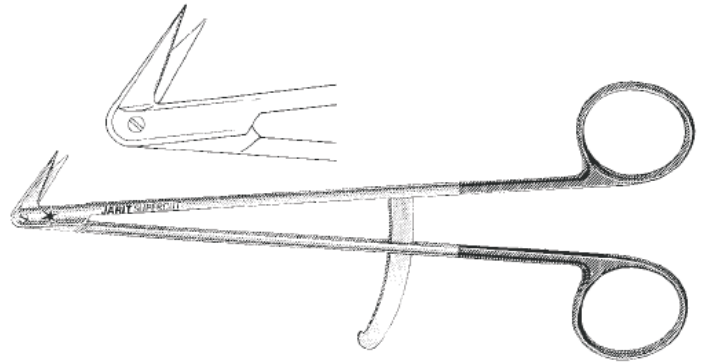
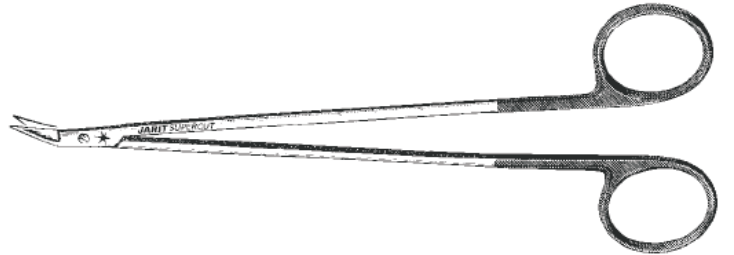

102-360 **DIETHRICH** Coronary Artery Scissors,  
7" (17.8cm), 130°, shanks are stabilized  
to keep blades in alignment

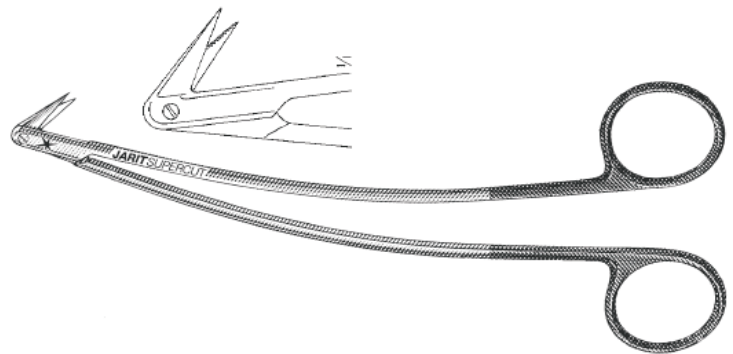

102-374 **FAVALORO** Scissors,  
6 3/4" (17cm), 125°

**PETIT-POINT**<sup>®</sup>

JARIT PETIT-POINT feature a matched and balanced set of fine, delicate hemostats, soft-tension intestinal clamps, delicate scissors, and needle holders, for pediatric and other delicate procedures.

**PETIT-POINT JACOBSON MOSQUITO** Forceps,  
5" (12.7cm)

- 105-088 Straight
- 105-089 Curved

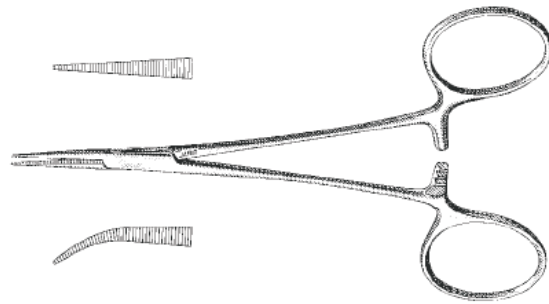

**PETIT-POINT MOSQUITO** Forceps

- 105-090 3<sup>7</sup>/<sub>8</sub>" (9.8cm), straight
- 105-091 3<sup>7</sup>/<sub>8</sub>" (9.8cm), curved
- 105-095 4<sup>3</sup>/<sub>8</sub>" (12.1cm), straight
- 105-096 4<sup>3</sup>/<sub>8</sub>" (12.1cm), curved

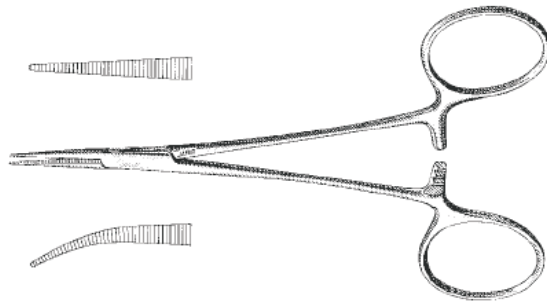

**PETIT-POINT MOSQUITO** Forceps,  
6" (15.2cm)

- 105-098 Straight
- 105-099 Curved

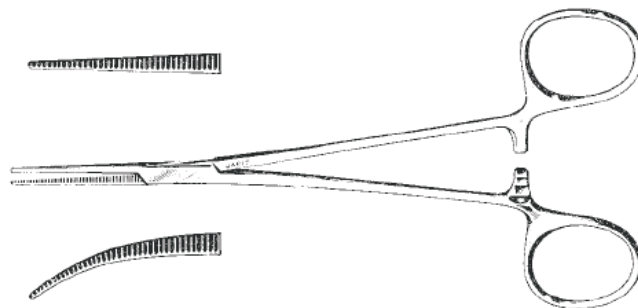



**PETIT-POINT MOSQUITO** Forceps,  
7½" (18.1cm)

- 285-107 Straight
- 285-108 Curved

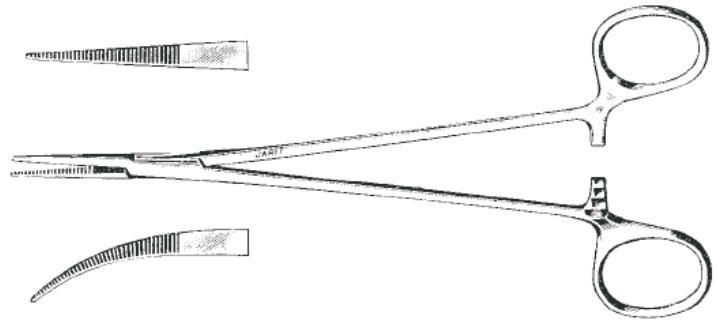

**PETIT-POINT CRILE** Forceps,  
5½" (14cm)

- 105-118 Straight
- 105-119 Curved

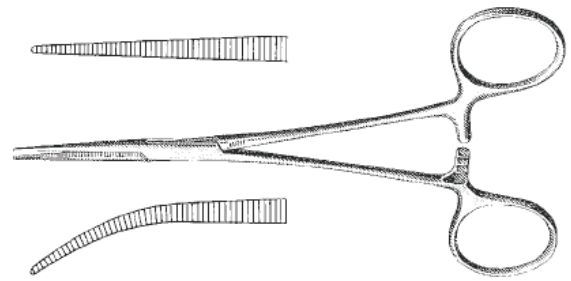

**PETIT-POINT PEAN** Forceps,  
5½" (14cm)

- 105-163 Straight
- 105-164 Curved

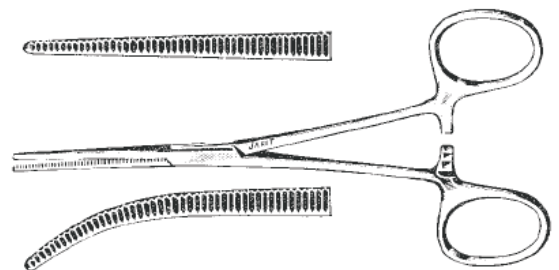

**PETIT-POINT OCHSNER** Forceps,  
5½" (14cm)

- 105-233 Straight
- 105-234 Curved

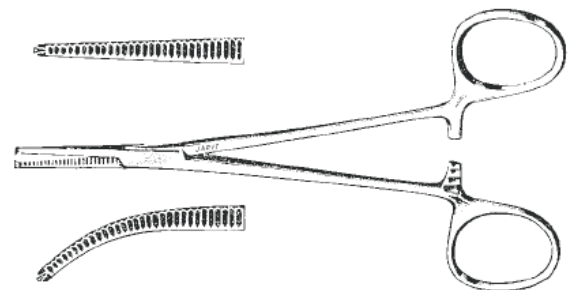

**101-255** PETIT-POINT REYNOLDS Scissors,  
5" (12.7cm), curved CARB-EDGE blades,  
one blade serrated

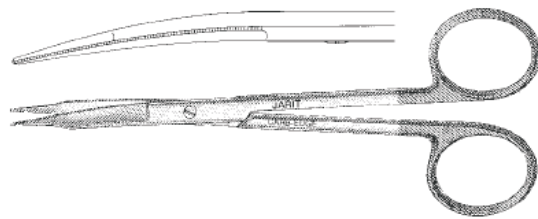

**PETIT-POINT OLSEN-HEGAR** Needle Holders,  
5" (12.7cm), delicate

- 120-148** Serrated
- 120-149** Smooth

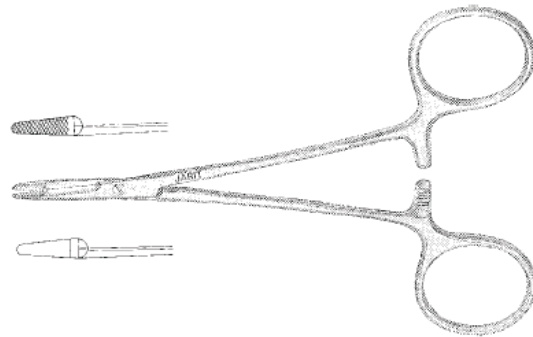

**PETIT-POINT OLSEN-HEGAR** Needle Holders,  
5" (12.7cm), delicate CARB-BITE jaws

- 121-148** Serrated
- 121-149** Smooth

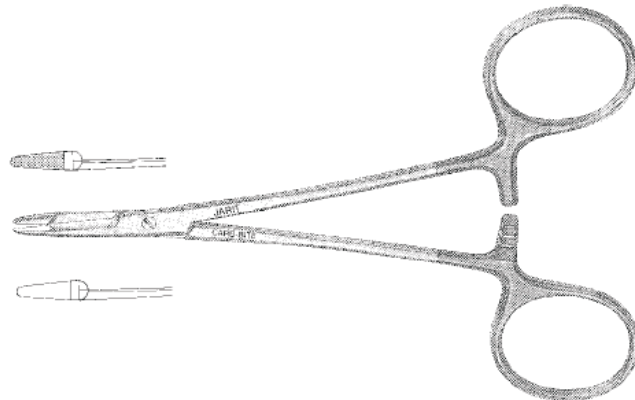

**PETIT-POINT RYDER** Needle Holders,  
1mm CARB-BITE jaws

- 121-170 5" (12.7cm), serrated
- 121-171 5" (12.7cm), smooth
- 121-172 6" (15.2cm), serrated
- 121-173 6" (15.2cm), smooth
- 121-174 7" (17.8cm), serrated
- 121-175 7" (17.8cm), smooth
- 121-176 8" (20.3cm), serrated
- 121-179 8" (20.3cm), smooth
- 121-177 9" (22.8cm), serrated
- 121-178 9" (22.8cm), smooth

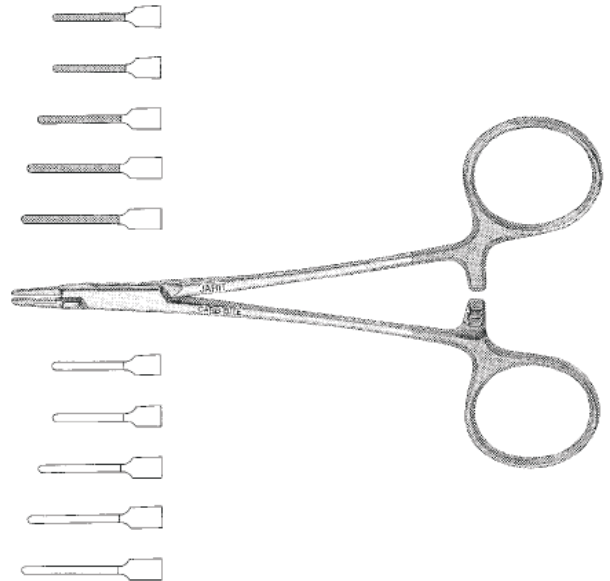

**PETIT-POINT SAROT** Needle Holders,  
CARB-BITE jaws, delicate

- 121-197 6" (15.2cm)
- 121-198 6 $\frac{1}{2}$ " (16.8cm)

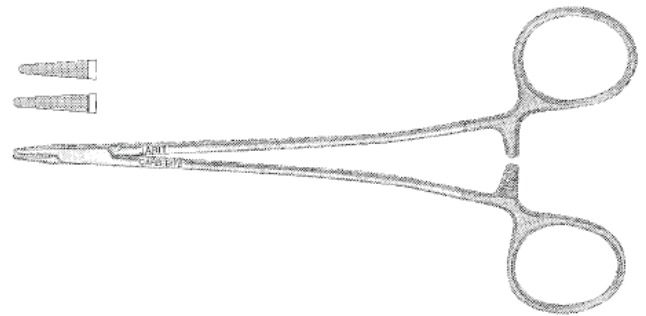

**135-095 PETIT-POINT ALLIS** Tissue Forceps,  
5 $\frac{1}{4}$ " (13.3cm), 4 x 5 teeth

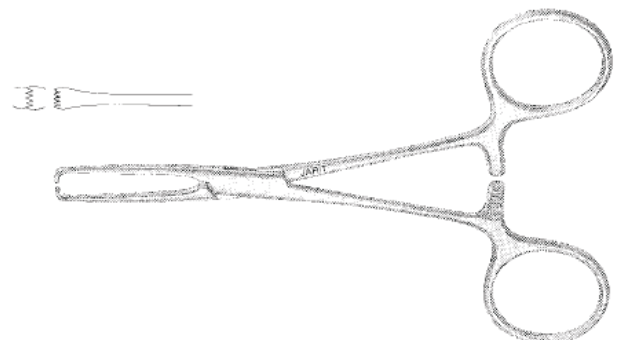

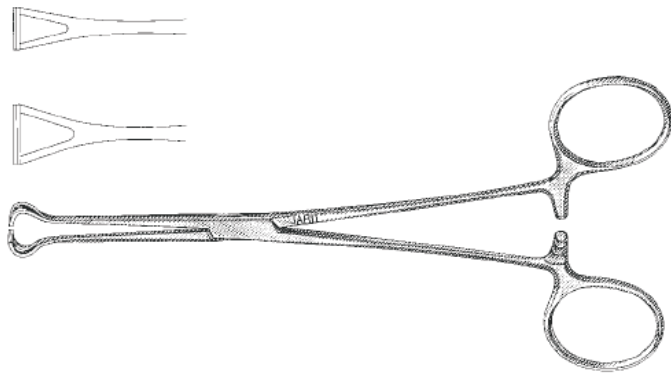

**PETIT-POINT BABCOCK** Forceps

- 135-179 5¼" (13.3cm), jaw width 6mm
- 135-180 6¼" (16cm), jaw width 7.5mm

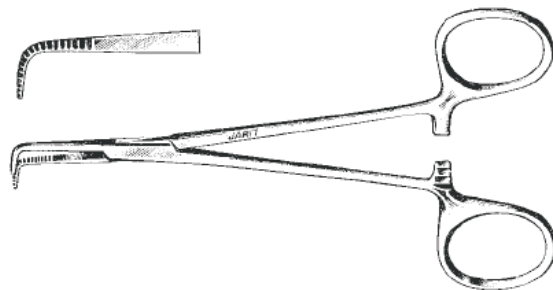

- 140-218 **PETIT-POINT MIXTER** Forceps,  
5¼" (13.3cm)



- 140-223 **PETIT-POINT MIXTER** Forceps,  
7¼" (18.4cm)

**HALSTEAD** Mosquito Forceps

Mirror	Satin	Matte	
105-100	106-100	107-100	5" (12.7cm), straight
105-102	106-102	107-102	5" (12.7cm), curved

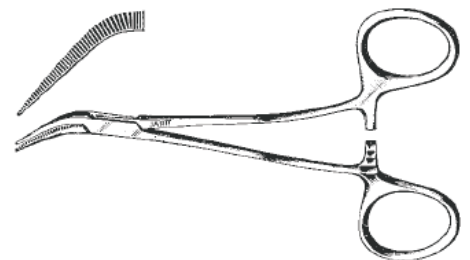
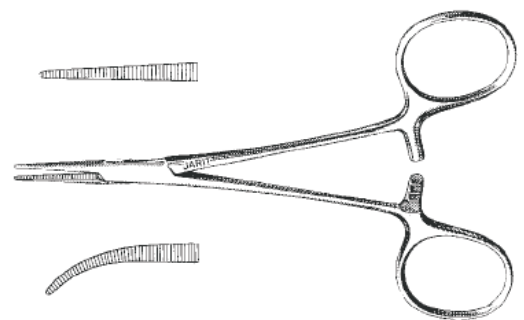

**105-105 HALSTEAD** Mosquito Forceps,  
5" (12.7cm), angled, mirror finish

**HALSTEAD** Mosquito Forceps,  
5" (12.7cm), 1 x 2 teeth, mirror finish

- 105-110 Straight
- 105-112 Curved

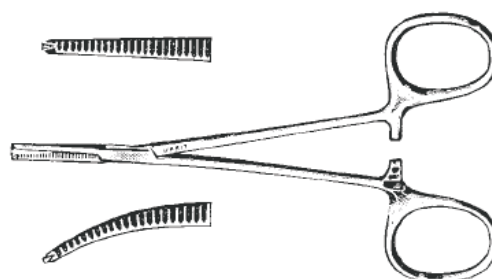

**HARTMAN** Mosquito Forceps,  
3½" (8.9cm)

- |         |         |          |
|---------|---------|----------|
| Mirror  | Matte   |          |
| 105-114 | 107-114 | Straight |
| 105-115 | 107-115 | Curved   |

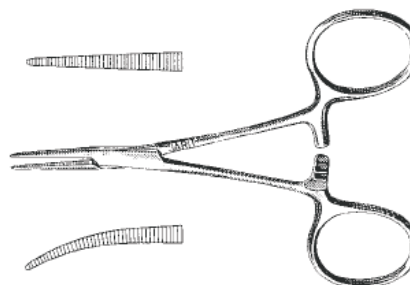

**CRILE** Forceps

Mirror	Satin	Matte	
105-120	106-120	107-120	5½" (14cm), straight
105-121	106-121	107-121	5½" (14cm), curved
105-140	106-140	107-140	6¾" (16cm), straight
105-141	106-141	107-141	6¾" (16cm), curved

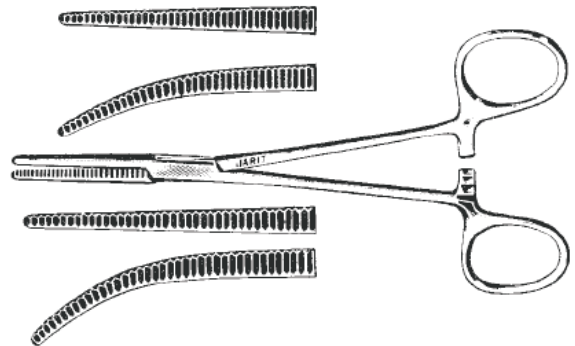

**KELLY** Forceps,  
5½" (14cm)

Mirror	Satin	Matte	
105-130	106-130	107-130	Straight
105-131	106-131	107-131	Curved

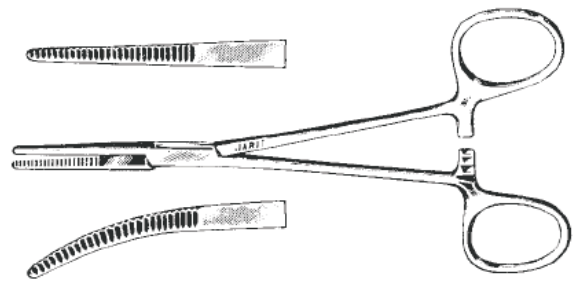



**COLLER-CRILE** Forceps,  
fine tapered tips, mirror finish

- 105-142 5½" (14cm), straight
- 105-143 6¼" (16cm), straight
- 105-144 5½" (14cm), curved
- 105-145 6¼" (16cm), curved

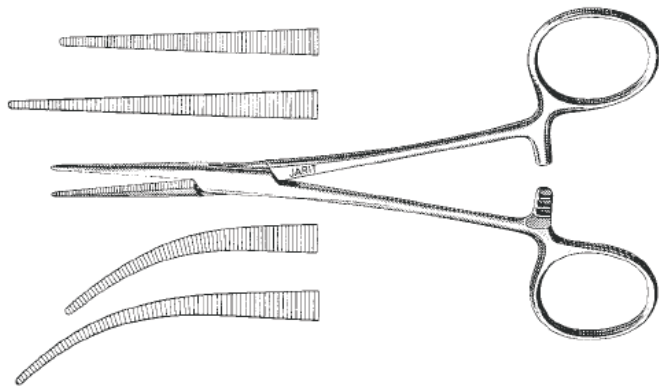

**RANKIN** Forceps,  
6¼" (16cm)

- |         |         |          |
|---------|---------|----------|
| Mirror  | Satin   |          |
| 105-150 | 106-150 | Straight |
| 105-151 | 106-151 | Curved   |

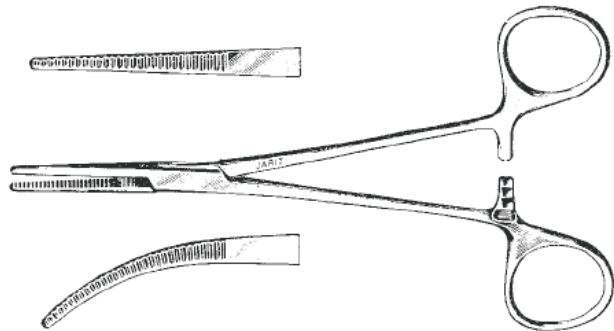

**PROVIDENCE HOSPITAL** Forceps,  
5½" (14cm), mirror

- 105-160 Straight
- 105-161 Curved

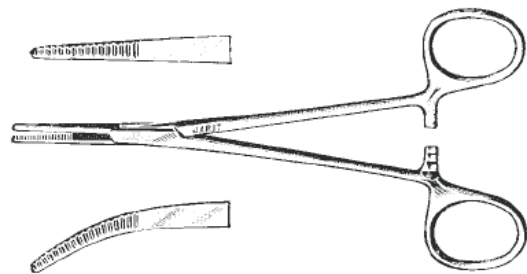

**ROCHESTER-PEAN Forceps**

Mirror	Satin	Matte	
105-168	106-168		5½" (14cm), straight
105-169	106-169		5½" (14cm), curved
105-170	106-170	107-170	6¼" (16cm), straight
105-171	106-171	107-171	6¼" (16cm), curved
105-180	106-180	107-180	7¼" (18.4cm), straight
105-181	106-181	107-181	7¼" (18.4cm), curved
105-190	106-190	107-190	8" (20.3cm), straight
105-191	106-191	107-191	8" (20.3cm), curved
105-195	106-195		9" (22.8cm), straight
105-196	106-196		9" (22.8cm), curved
105-197			10" (25.4cm), straight
105-198			11" (27.9cm), straight
105-199			12" (30.5cm), straight

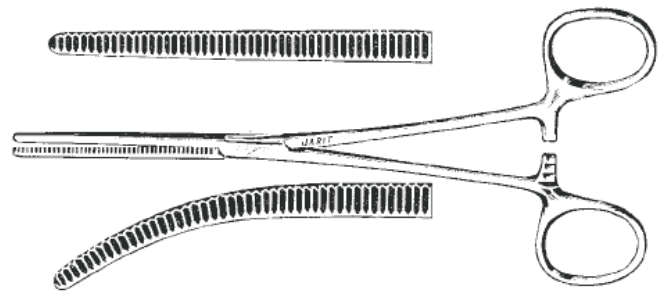

**ROCHESTER-OCHSNER Forceps**

Mirror	Satin	Matte	
105-200	106-200	107-200	6¼" (16cm), straight
105-202	106-202		6¼" (16cm), curved
105-210	106-210	107-210	7¼" (18.4cm), straight
105-212	106-212		7¼" (18.4cm), curved
105-220	106-220	107-220	8" (20.3cm), straight
105-222	106-222		8" (20.3cm), curved
105-223			9" (22.8cm), straight
105-224			9" (22.8cm), curved
105-225			10" (25.4cm), straight
105-226			10" (25.4cm), curved
105-227			11" (27.9cm), straight
105-229			12" (30.5cm), straight
105-228			14" (35.6cm), straight

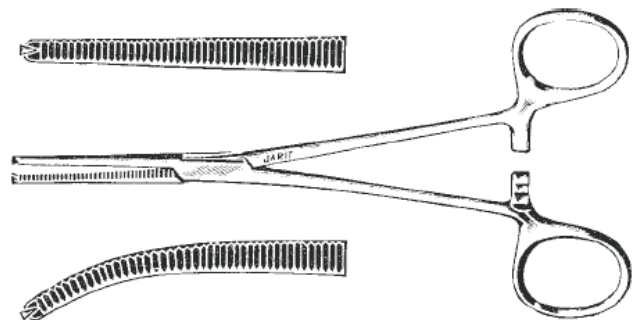

**KOCHER** Forceps,  
5½" (14cm)

Mirror     Satin

- |         |         |          |
|---------|---------|----------|
| 105-230 | 106-230 | Straight |
| 105-232 | 106-232 | Curved   |

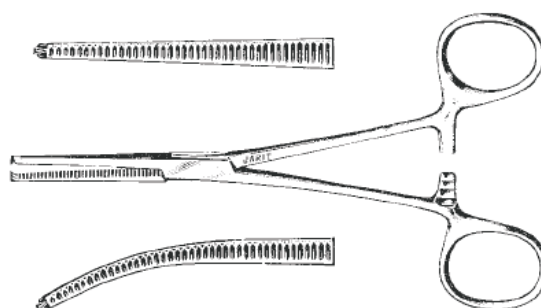

**ROCHESTER-CARMALT** Forceps

- |         |                       |
|---------|-----------------------|
| 105-240 | 6¼" (16cm), straight  |
| 105-242 | 6¼" (16cm), curved    |
| 105-243 | 8" (20.3cm), straight |
| 105-245 | 8" (20.3cm), curved   |

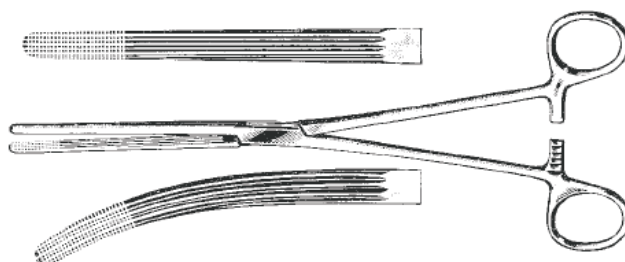

**JONES** Forceps,  
5" (12.7cm)

- 105-250 Straight
- 105-251 Curved

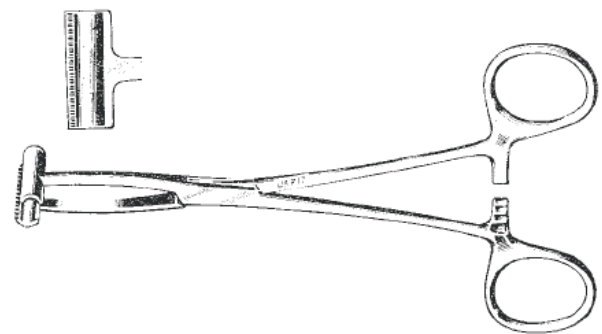
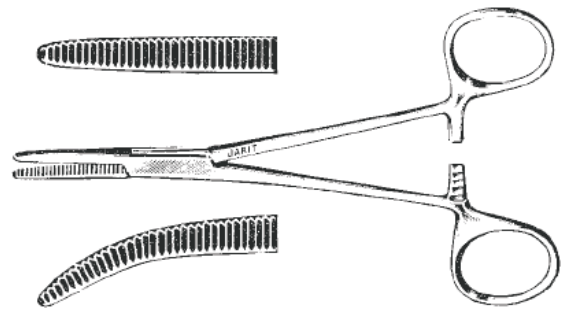

- 105-255 **PRATT** T-Clamp,  
5 7/8" (15cm)

**SERREFINE** Forceps

- 105-260 1½" (3.8cm), straight
- 105-261 1½" (3.8cm), curved
- 105-262 2½" (6.4cm), straight
- 105-263 2½" (6.4cm), curved

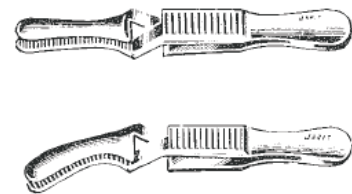

**FERGUSON** Angiotribe,  
6½" (16.5cm)

- 105-270 Straight
- 105-271 Curved

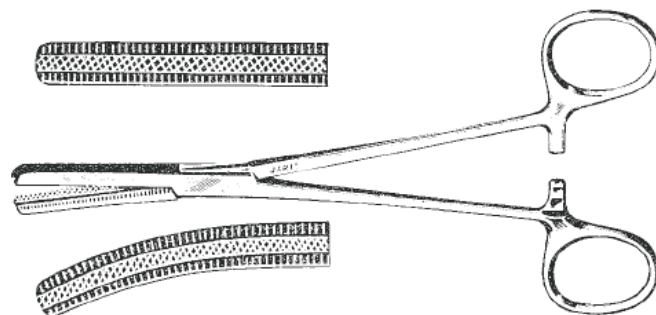

**BAINBRIDGE** Forceps

- 105-300 6" (15.2cm), straight
- 105-302 6" (15.2cm), curved
- 105-304 7½" (18.4cm), straight
- 105-306 7½" (18.4cm), curved

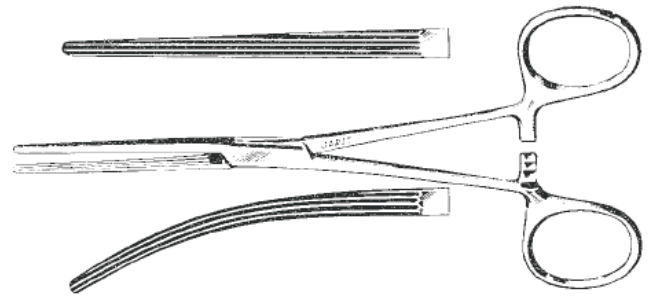

- 105-320 **PENNINGTON** Forceps,  
5¾" (14.6cm), triangular jaws

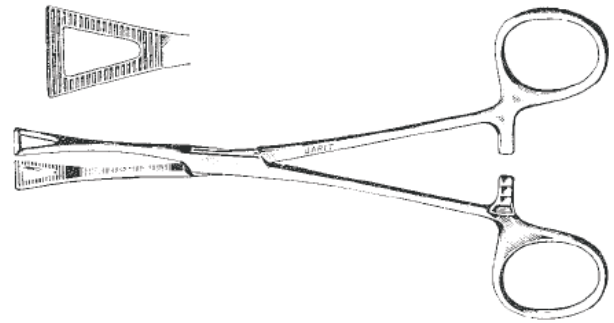

- COLLER** Forceps,  
9½" (241mm), full horizontal serrations

- 105-330 Curved
- 105-331 Strong curve
- 105-332 Right angle

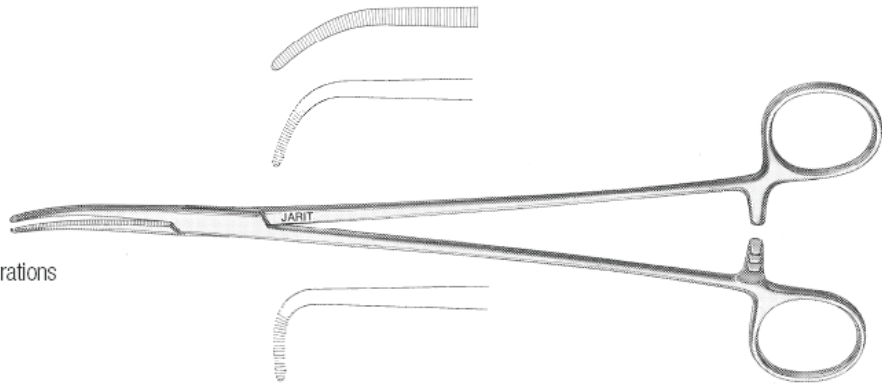

- STOREY** Forceps  
8¾" (222mm), cross serrations

- 105-340 Slight curve
- 105-341 Strong curve
- 105-342 Right angle

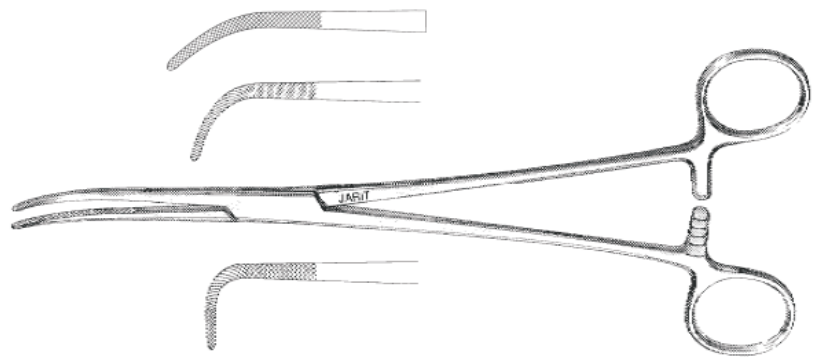

**BACKHAUS** Towel Forceps

Mirror	Satin	Matte	
110-100	111-100	109-100	3½" (8.9cm)
110-102	111-102	109-102	5¼" (13.3cm)

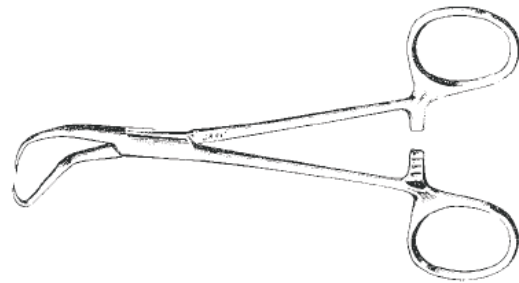

110-105 **ROEDER** Towel Forceps,  
5¼" (13.3cm)

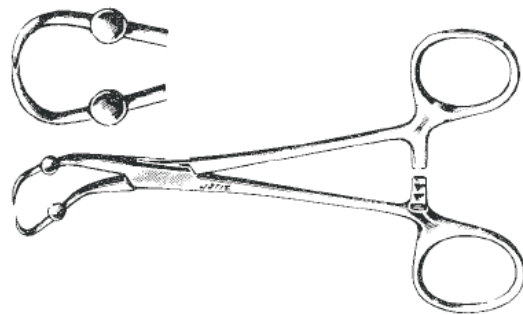

**JONES** Towel Forceps,  
cross-action

**110-110** 3" (7.6cm)

**110-111** 2½" (5.7cm)

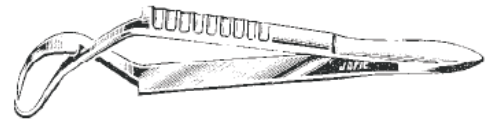

**JARIT** Towel Forceps,  
with non-perforating jaws

**110-117** 4" (10.1cm)

**110-118** 5½" (13.3cm)

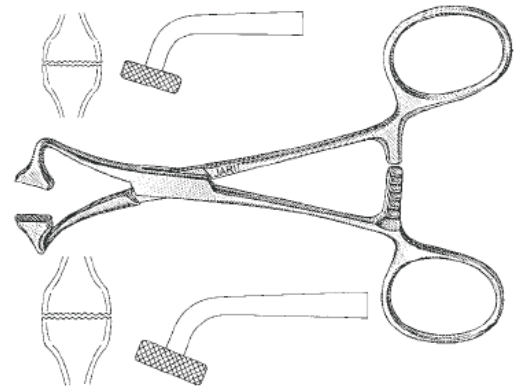



**EDNA** Towel Forceps

Mirror     Matte

110-119    109-119    4" (10.1cm)

110-120    109-120    5½" (14cm)

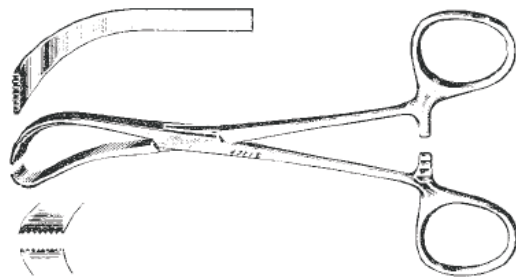

110-121    **PEERS** Towel Forceps,  
5¾" (14.6cm)

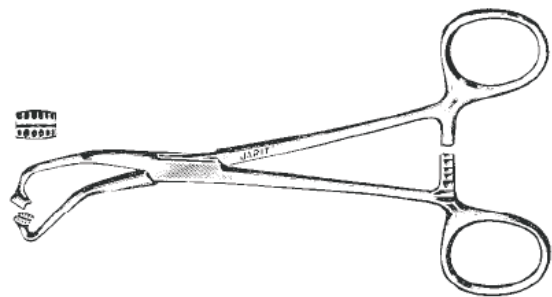

**110-150** PRESBYTERIAN HOSPITAL Tube Occluding Forceps,  
6½" (16.5cm)

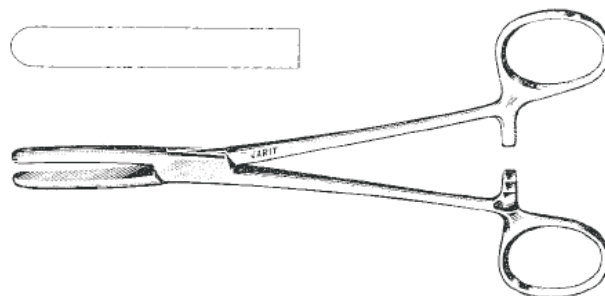

**110-154** JARIT Tube Occluding Forceps,  
5½" (14cm), delicate jaws with smooth  
inner surfaces, beveled edges

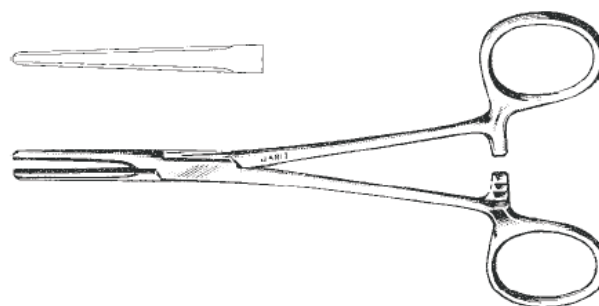

## JARIT® TUBE OCCLUDING FORCEPS

### JARIT (VORSE) Tube Occluding Forceps

- 110-155 5½" (14cm)
- 110-157 7¼" (18.4cm)
- 110-159 8" (20.3cm), heavy jaw

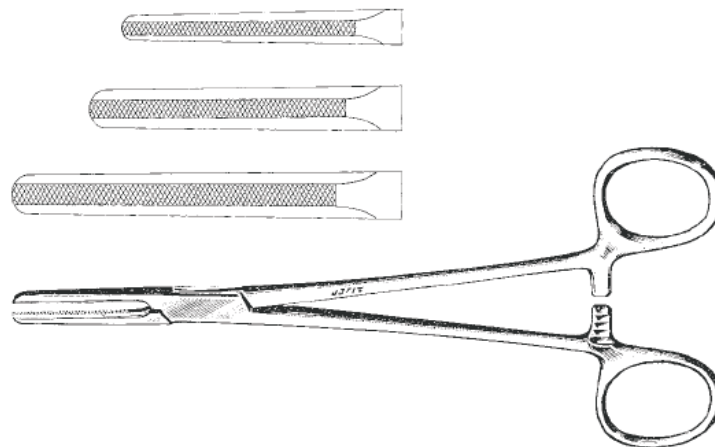

### JARIT Tube Occluding Forceps, with U-shaped guard

- 110-160 5½" (14cm)
- 110-161 7¼" (18.4cm)
- 110-162 8" (20.3cm), heavy jaw

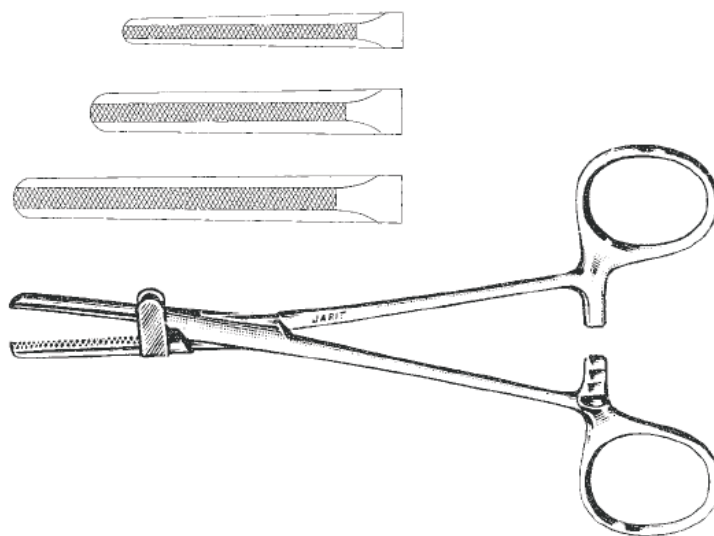

## JARIT SCALPEL HANDLES

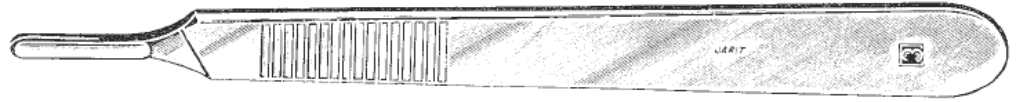

**KNIFE HANDLE #3,**  
holds blades 10, 11, 12, 15  
Length 5" (12.7cm)

Satin     Matte  
**110-165    110-175**



**KNIFE HANDLE #4,**  
holds blades 20 thru 25  
Length 5¼" (13.3cm)

Satin     Matte  
**110-167    110-176**



**KNIFE HANDLE #7,**  
holds blades 10, 11, 12, 15  
Length 6½" (16.5cm)

Satin     Matte  
**110-169    110-177**



**KNIFE HANDLE #3L,**  
for deep surgery,  
holds blades 10, 11, 12, 15  
Length 8¾" (21.3cm)

Satin     Matte  
**110-170    110-178**



**KNIFE HANDLE #3LA,**  
angled, for deep surgery,  
holds blades 10, 11, 12, 15  
Length 8¾" (21.3cm)

Satin  
**110-171**

**JARIT** SCALPEL HANDLES



**KNIFE HANDLE #4L,**  
for deep surgery,  
holds blades 20-25

110-173 Length 8 $\frac{3}{4}$ " (21.3cm)



**KNIFE HANDLE #9 (7K),**  
holds blades 10, 11, 12, 15

110-174 Length 5" (12.7cm)



**BARRON** Knife Handle,  
octagonal handle,  
holds blades 10, 11, 12, 15

110-180 Length 5 $\frac{1}{2}$ " (14cm)



**CORWIN** Knife Handle,  
round knurled handle,  
holds blades 10, 11, 12, 15

110-182 Length 5 $\frac{3}{4}$ " (13.7cm)



**KNIFE HANDLE,**  
round knurled handle,  
holds miniature blades (e.g. series 50, 60, 70)

110-190 **#3KS,** 4" (10.1cm)

110-191 **#3KL,** 6" (15.2cm)

110-198 **#3K/H** replacement collet



**KNIFE HANDLE,**  
hexagonal handle  
holds miniature blades (e.g. series 50, 60, 70)

110-194 **#3HS,** 4" (10.1cm)

110-195 **#3HL,** 6" (15.2cm)

110-198 **#3K/H** replacement collet



**FOERSTER** Sponge Holding Forceps

Mirror	Satin	Matte	
115-100	116-100		7" (17.8cm), straight, smooth
115-102	116-102	114-102	7" (17.8cm), straight, serrated
115-105	116-105		9½" (24.1cm), straight, smooth
115-107	116-107	114-107	9½" (24.1cm), straight, serrated
115-110	116-110		7" (17.8cm), curved, smooth
115-112	116-112		7" (17.8cm), curved, serrated
115-115	116-115		9½" (24.1cm), curved, smooth
115-117	116-117		9½" (24.1cm), curved, serrated
		114-124	14" (35.6cm), straight, serrated

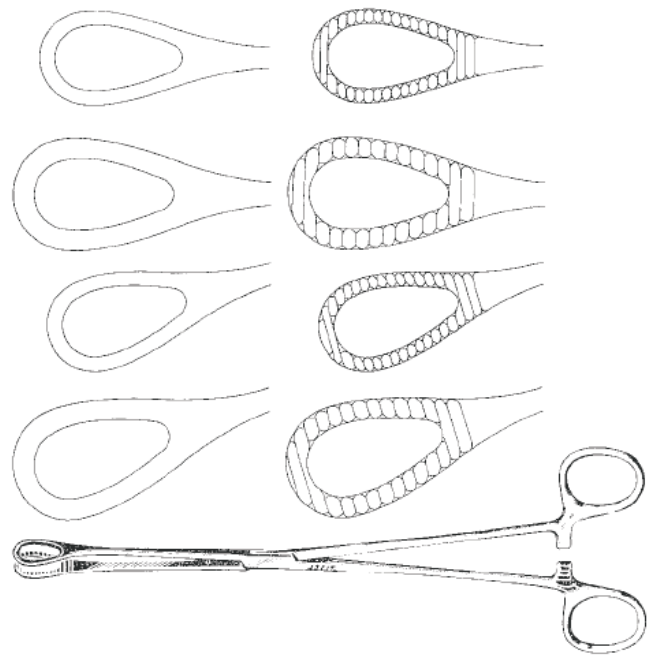

**FLETCHER** Sponge Forceps,  
9½" (24.1cm)

115-119	Straight
115-120	Curved

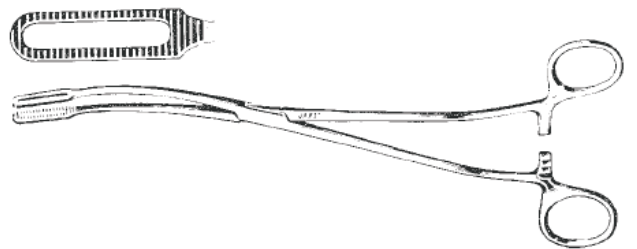

## **Jarll** STERILIZING TRAYS AND AIDS

### Instrument Sterilizing Trays

- 117-100 5" x 15½" x 3" (12.7 x 39.4 x 7.6cm)
- 117-102 6" x 24" x 3½" (15.2 x 61 x 8.9cm)
- 117-106 8" x 25¼" x 3½" (20.3 x 64.2 x 8.9cm)
- 117-108 10" x 6½" x 2½" (25.4 x 16.5 x 6.4cm)
- 117-110 10½" x 10" x 3½" (26.7 x 25.4 x 8.9cm)
- 117-112 10½" x 15" x 3½" (26.7 x 38.1 x 8.9cm)
- 117-114 10½" x 20" x 3½" (26.7 x 50.8 x 8.9cm)
- 117-116 13" x 20¼" x 3½" (33 x 51.5 x 8.9cm), handles inside
- 117-118 13" x 20¼" x 3½" (33 x 51.5 x 8.9cm), handles outside



(NOT PICTURED)

- 117-120 **Lifting Handles** for lifting and carrying sterilization trays, set of 2

### Covered Instrument Sterilization Trays with positive locking latch. Removable cover can be stored under tray during use.

- 117-130 5" x 15½" x 3" (12.7 x 39.4 x 7.6cm)
- 117-132 6" x 24" x 3½" (15.2 x 61 x 8.9cm)
- 117-136 8" x 25¼" x 3½" (20.3 x 64.2 x 8.9cm)
- 117-138 10" x 6½" x 2½" (25.4 x 16.5 x 6.4cm)
- 117-140 10½" x 10" x 3½" (26.7 x 25.4 x 8.9cm)
- 117-142 10½" x 15" x 3½" (26.7 x 38.1 x 8.9cm)
- 117-144 10½" x 20" x 3½" (26.7 x 50.8 x 8.9cm)
- 117-148 13" x 20¼" x 3½" (33 x 51.5 x 8.9cm)



### MAYO Trays Perforated

- 117-160 10" x 6½" x ¾" (25.4 x 16.5 x 2cm)
- 117-162 13½" x 9¾" x ¾" (34.3 x 24.8 x 2cm)
- 117-164 15" x 10½" x ¾" (38.1 x 27 x 2cm)
- 117-166 17" x 11½" x ¾" (43.2 x 29.5 x 2cm)
- 117-168 19" x 12½" x ¾" (48.3 x 32.1 x 2cm)
- 117-170 21¼" x 16¼" x ¾" (54 x 41.3 x 2cm)







**Flash Autoclaving Pans,  
Tray and Safety Handle**

- 117-180 Pan, 9" x 5" x 2" (23 x 12.7 x 5.1cm)
- 117-182 Pan, 10" x 6½" x 2½" (25.4 x 16.5 x 6.3cm)
- 117-184 Tray, 10" x 6½" x 2½" (25.4 x 16.5 x 6.3cm)
- 117-188 Safety Handle

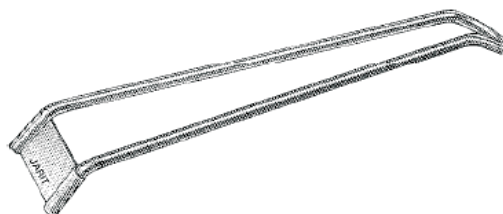

**Deep Perforated Instrument Pans**

- 117-190 9" x 5" x 2" (23 x 12.7 x 5.1cm)
- 117-192 10" x 6½" x 2" (25.4 x 16.5 x 5.1cm)
- 117-194 12¼" x 7¾" x 2½" (31.1 x 19.7 x 6.3cm)
- 117-196 12¾" x 10½" x 2½" (32.4 x 26.7 x 6.3cm)
- 117-198 16" x 10" x 2½" (40.6 x 25.4 x 6.3cm)
- 117-199 20¾" x 12¾" x 2½" (52.7 x 32.4 x 6.3cm)



**WEINSTEIN Instrument Holders,  
width 2½" (6.3cm)**

- 117-240 6" (15.2cm)
- 117-242 8" (20.3cm)
- 117-244 10" (25.4cm)
- 117-246 12" (30.5cm)
- 117-247 14" (35.6cm)
- 117-248 16" (40.6cm)
- 117-249 18" (45.7cm)

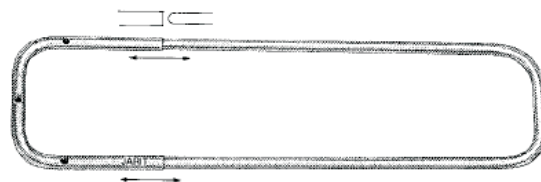

**JARIT Instrument Holders,  
width 2½" (6.3cm)**

- 117-250 6" (15.2cm)
- 117-252 8" (20.3cm)
- 117-254 10" (25.4cm)
- 117-256 12" (30.5cm)
- 117-258 14" (35.6cm)
- 117-260 16" (40.6cm)
- 117-262 18" (45.7cm)





**Instrument Stringers**

- 117-270 8" x 2½" (20.3 x 6.3cm)
- 117-272 10" x 2½" (25.4 x 6.3cm)
- 117-274 12" x 2½" (30.5 x 6.3cm)
- 117-276 14" x 2½" (35.6 x 6.3cm)
- 117-278 16" x 2½" (40.6 x 6.3cm)
- 117-280 18" x 2½" (45.7 x 6.3cm)

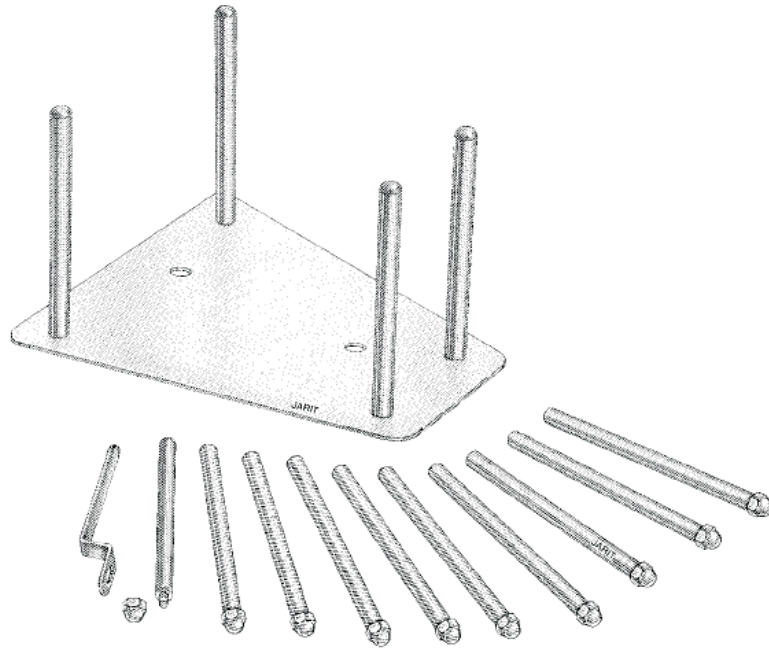

- 117-330 **Instrument Rack,**  
with four vertical pins,  
keeps box locks open during sterilization

- 117-340 **Tray Pins,**  
box of 10

- 118-116 **BUNT** Forceps Holder



- JARIT** Forceps Holder
- 118-118 6" (15.2cm)
- 118-119 12" (30.5cm)



## **JART** CUPS AND BASINS

**117-370 GRADUATED MEASURE**  
4 $\frac{3}{4}$ " x 5 $\frac{1}{4}$ " (12.1 x 13.3cm), 32 oz



**SOLUTIONS BASIN**  
**117-380** 13 $\frac{5}{8}$ " x 4 $\frac{5}{8}$ " (34.6 x 11.7cm), 7 qt  
**117-381** 14 $\frac{1}{2}$ " x 5" (36.8 x 12.7cm), 9 $\frac{1}{2}$  qt



**117-360 IODINE CUP**  
3 $\frac{3}{8}$ " x 2" (8.6 x 5.1cm), 6 oz



**117-365 MEDICINE CUP**  
2 $\frac{1}{8}$ " x 2" (5.4 x 5.1cm), 2 oz, graduated



**EMESIS BASIN**  
**117-390** 6 $\frac{5}{8}$ " x 3 $\frac{1}{2}$ " x 1 $\frac{1}{2}$ " (16.8 x 8.9 x 3.8cm), 10 oz  
**117-391** 8 $\frac{1}{8}$ " x 3 $\frac{5}{8}$ " x 1 $\frac{3}{8}$ " (20.6 x 9.2 x 4.1cm), 12 oz  
**117-392** 9 $\frac{1}{8}$ " x 4 $\frac{1}{2}$ " x 2 $\frac{1}{8}$ " (25.1 x 11.4 x 5.4cm), 26 oz



120-090 **CONVERSE** Needle Holder,  
4 $\frac{1}{4}$ " (10.8cm), large finger rings

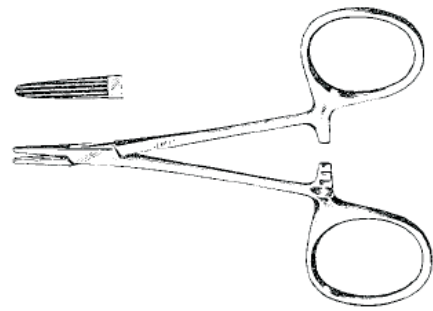

120-095 **BROWN** Needle Holder,  
5 $\frac{1}{4}$ " (13.3cm)

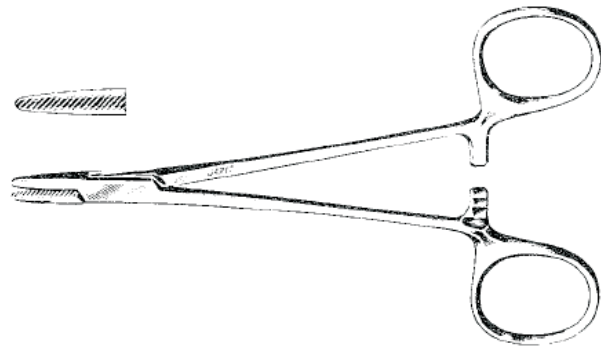

120-097 **NEIVERT** Needle Holder,  
5" (12.7cm), thumb ring turned up

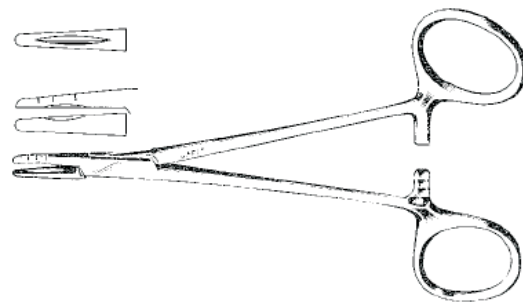

**120-100** DERF Needle Holder,  
4 $\frac{1}{4}$ " (12.1cm)

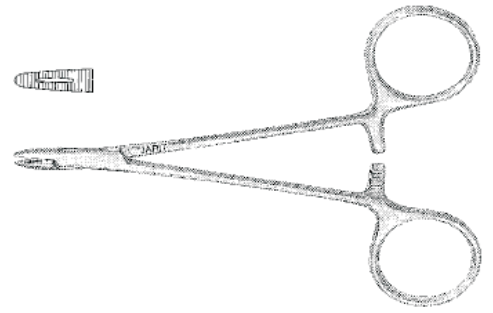

**120-105** BAUMGARTNER Needle Holder,  
5 $\frac{1}{4}$ " (13.3cm), solid jaws

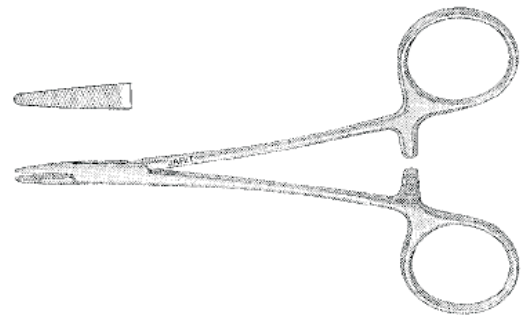

**120-110** BAUMGARTNER Needle Holder,  
5 $\frac{1}{4}$ " (13.3cm), grooved jaws

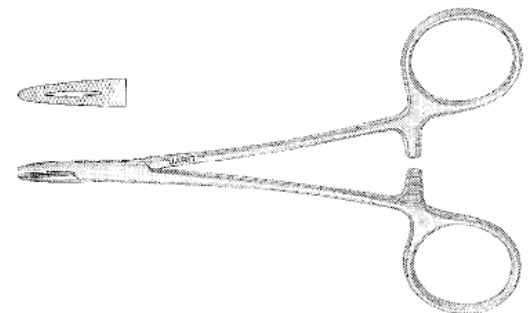

**120-112** HEGAR-BAUMGARTNER Needle Holder,  
5 $\frac{1}{2}$ " (14cm), solid jaws

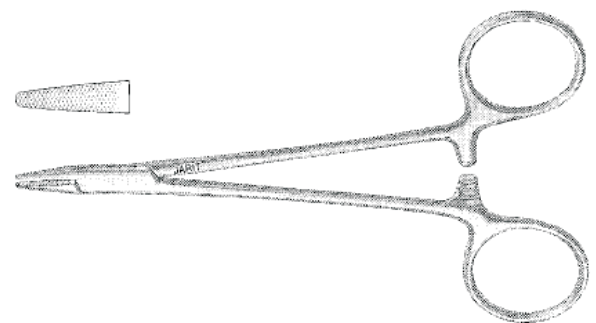

**JARIT** NEEDLE HOLDERS

**120-115 COLLIER** Needle Holder,  
5" (12.7cm)

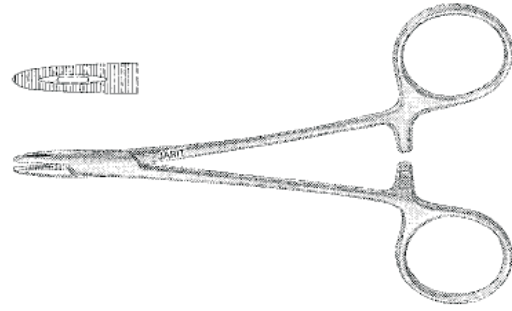

**120-118 WEBSTER** Needle Holder,  
4½" (11.4cm), smooth jaws

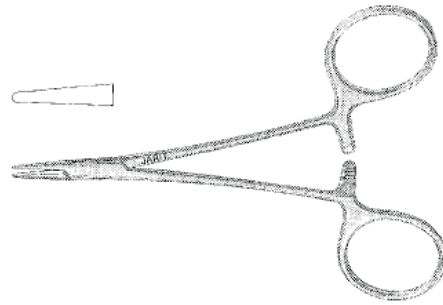

**120-120 HALSEY** Needle Holder,  
5" (12.7cm), smooth jaws

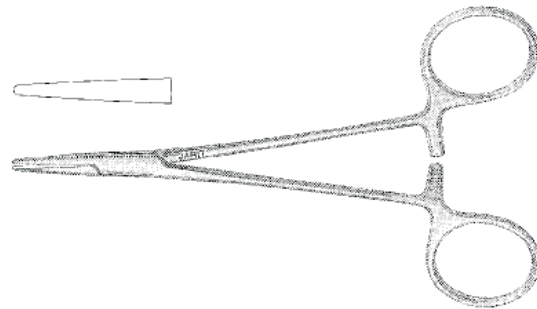

**120-125 NEW ORLEANS** Needle Holder,  
7" (17.8cm)

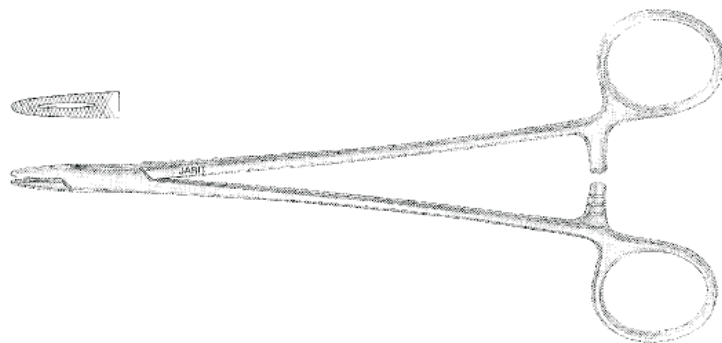

**CRILE-WOOD** Needle Holders

- 120-130 6" (15.2cm)
- 120-131 7" (17.8cm)
- 120-132 8" (20.3cm)

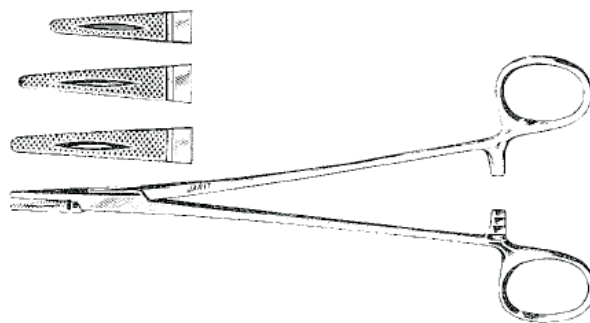

**MAYO-HEGAR** Needle Holders

- 120-135 6" (15.2cm)
- 120-140 7" (17.8cm)
- 120-145 8" (20.3cm)
- 120-147 12" (30.5cm)

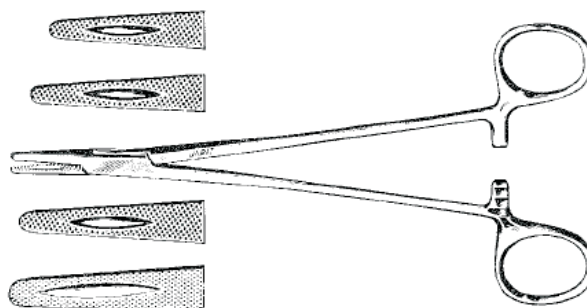

**PETIT-POINT OLSEN-HEGAR** Needle Holders,  
5" (12.7cm), delicate

- 120-148 Serrated
- 120-149 Smooth

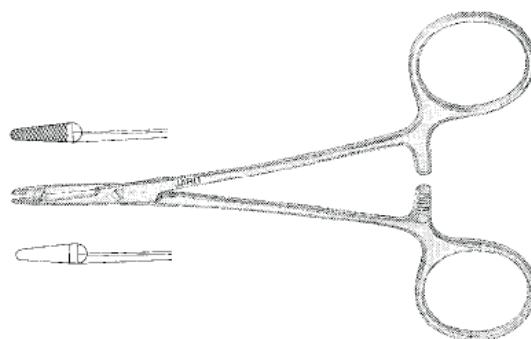

**OLSEN-HEGAR** Needle Holders

- 120-150 5½" (14cm)
- 120-155 6½" (16.5cm)

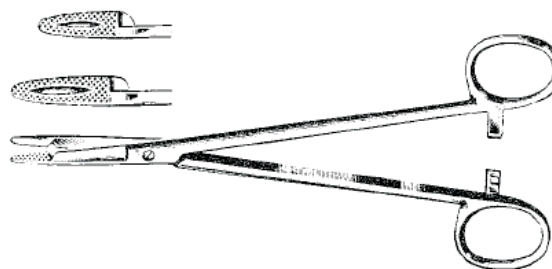

**JARIT** NEEDLE HOLDERS

120-180 **MASSON** Needle Holder,  
10½" (26.6cm)

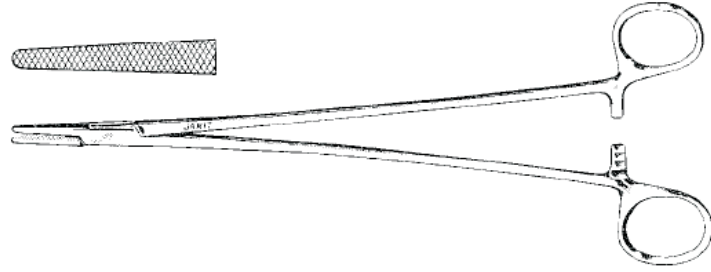

120-200 **SAROT** Needle Holder,  
7½" (18.1cm), delicate

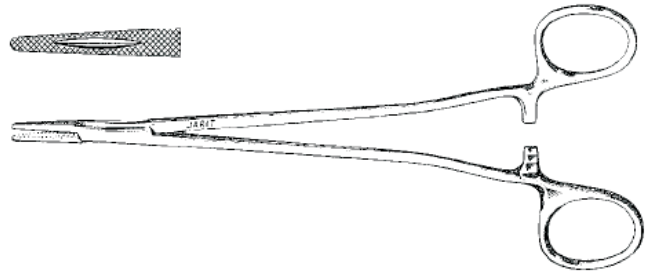

120-210 **HEANEY** Needle Holder,  
8¼" (21cm), curved

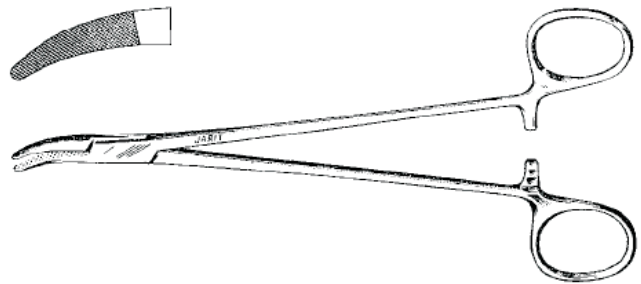

120-215 **JARIT** Bayonet Needle Holder,  
6¾" (17.1cm), fine tapered jaws

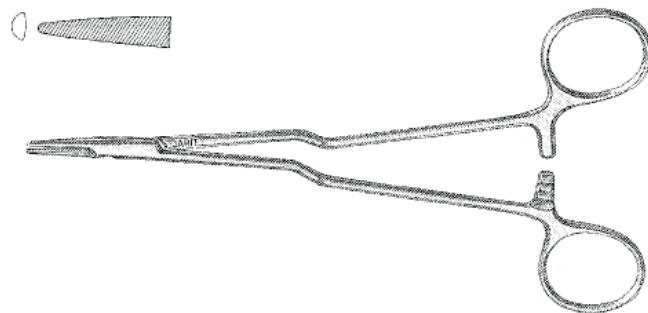

**JARIT** CARB-BITE NEEDLE HOLDERS

JARIT CARB-BITE Needle Holders feature jaw inserts of solid tungsten carbide. Sharply defined serrations have been milled into these inserts to provide a secure hold on the suture needle.

Because tungsten carbide is much harder than stainless steel, the useful life of CARB-BITE

Needle Holders greatly exceeds that of ordinary needle holders. JARIT CARB-BITE Needle Holders are guaranteed for a minimum of three years of normal usage. If jaw serrations should wear smooth while under guarantee, new CARB-BITE inserts will be installed without charge. Finger rings are gold plated for easy identification.

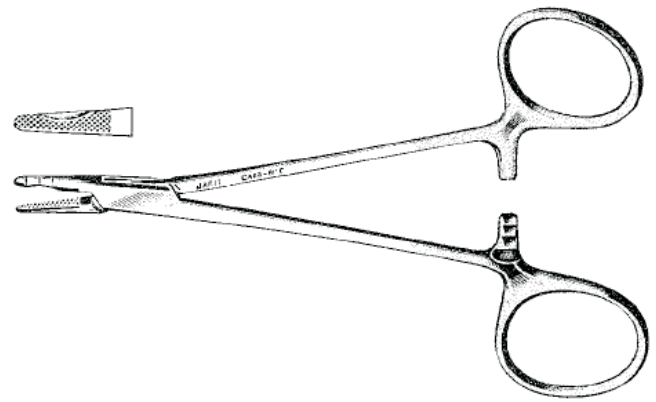

**121-097 NEIVERT** Needle Holder,  
5" (12.7cm), thumb ring turned up

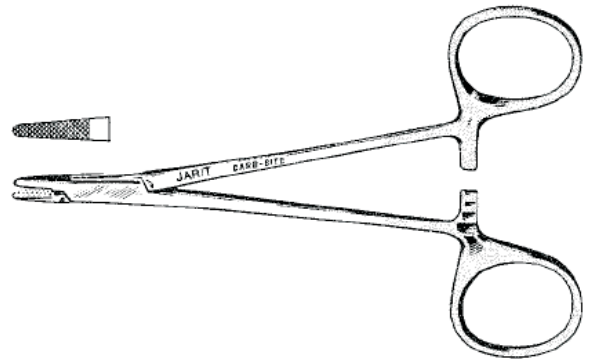

**121-100 DERF** Needle Holder,  
4 3/4" (12.1cm)

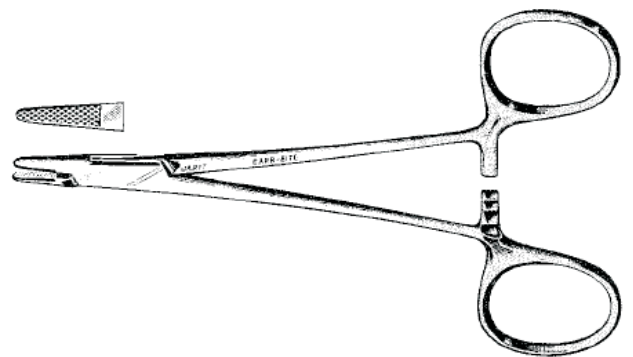

**BAUMGARTNER** Needle Holder,  
5 1/4" (13.3cm)

Satin Matte  
**121-105 123-105**



## JARIT CARB-BITE NEEDLE HOLDERS

JARIT CARB-BITE Needle Holders feature jaw inserts of solid tungsten carbide. Sharply defined serrations have been milled into these inserts to provide a secure hold on the suture needle.

Because tungsten carbide is much harder than stainless steel, the useful life of CARB-BITE

Needle Holders greatly exceeds that of ordinary needle holders. JARIT CARB-BITE Needle Holders are guaranteed for a minimum of three years of normal usage. If jaw serrations should wear smooth while under guarantee, new CARB-BITE inserts will be installed without charge. Finger rings are gold plated for easy identification.

**HEGAR-BAUMGARTNER** Needle Holder,  
5½" (14cm)  
Satin      Matte  
**121-106**   **123-106**

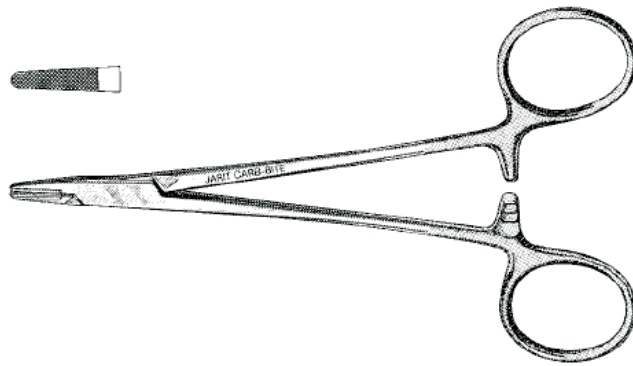

**JARIT PLASTIC AND RECONSTRUCTIVE** Needle Holders,  
4¾" (12cm)  
**121-115**   Serrated  
**121-116**   Smooth

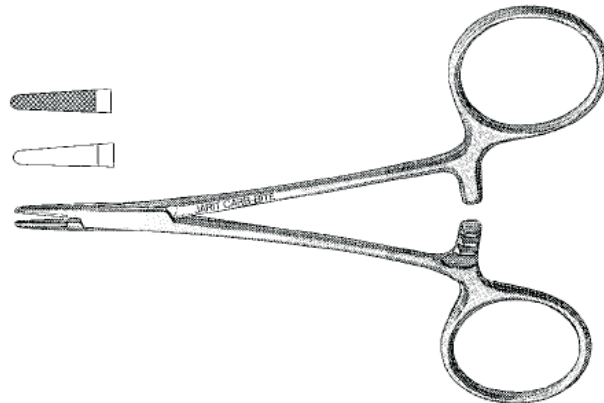

**WEBSTER** Needle Holder,  
**121-118**   4½" (11.4cm), smooth  
**121-119**   4½" (11.4cm), serrated

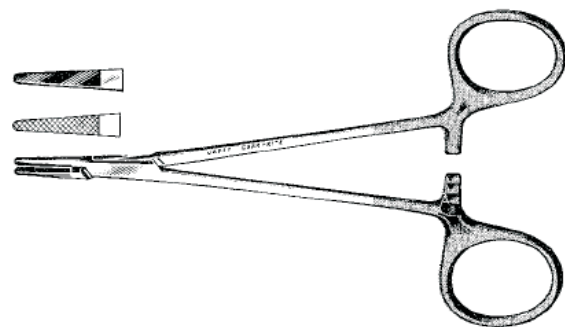

## **JARIT** CARB-BITE NEEDLE HOLDERS

JARIT CARB-BITE Needle Holders feature jaw inserts of solid tungsten carbide. Sharply defined serrations have been milled into these inserts to provide a secure hold on the suture needle.

Because tungsten carbide is much harder than stainless steel, the useful life of CARB-BITE

Needle Holders greatly exceeds that of ordinary needle holders. JARIT CARB-BITE Needle Holders are guaranteed for a minimum of three years of normal usage. If jaw serrations should wear smooth while under guarantee, new CARB-BITE inserts will be installed without charge. Finger rings are gold plated for easy identification.

**121-120** HALSEY Needle Holder,  
5" (12.7cm), smooth

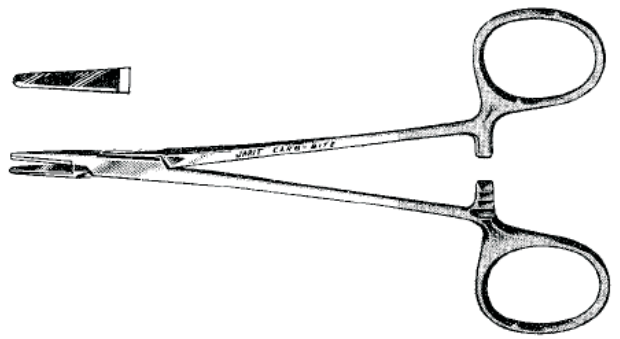

**121-121** HALSEY Needle Holder,  
5" (12.7cm), serrated

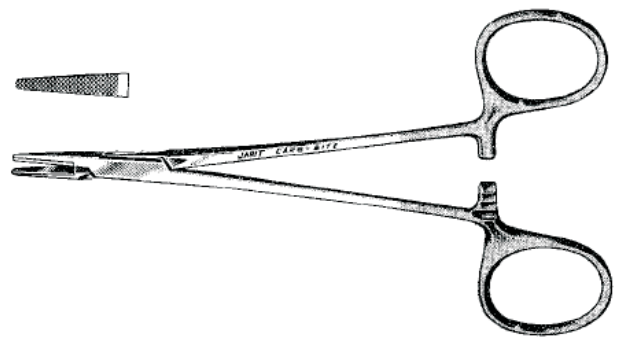

**121-125** NEW ORLEANS Needle Holder,  
7" (17.8cm)

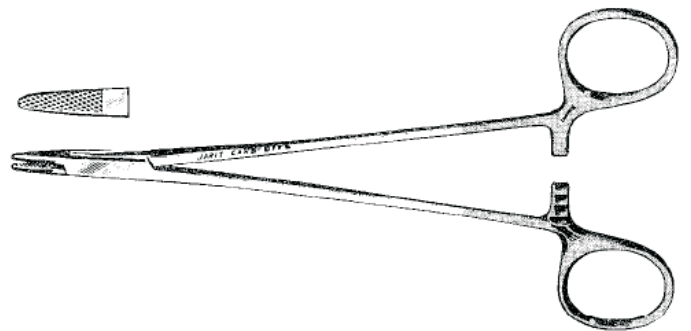

## JARIT CARB-BITE NEEDLE HOLDERS

JARIT CARB-BITE Needle Holders feature jaw inserts of solid tungsten carbide. Sharply defined serrations have been milled into these inserts to provide a secure hold on the suture needle.

Because tungsten carbide is much harder than stainless steel, the useful life of CARB-BITE

Needle Holders greatly exceeds that of ordinary needle holders. JARIT CARB-BITE Needle Holders are guaranteed for a minimum of three years of normal usage. If jaw serrations should wear smooth while under guarantee, new CARB-BITE inserts will be installed without charge. Finger rings are gold plated for easy identification.

### CRILE-WOOD Needle Holders, curved

<b>121-126</b>	7" (17.8cm)
<b>121-127</b>	9" (22.8cm)

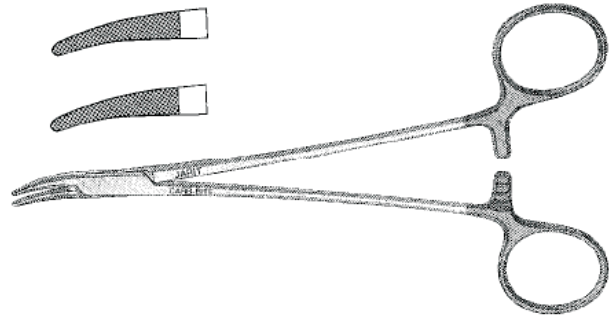

### CRILE-WOOD Needle Holder

Satin	Matte		
<b>121-130</b>	<b>123-130</b>	6"	(15.2cm)
<b>121-131</b>	<b>123-131</b>	7"	(17.8cm)
<b>121-132</b>	<b>123-132</b>	8"	(20.3cm)
<b>121-133</b>		9"	(22.8cm)
<b>121-134</b>		10 1/4"	(26cm)
<b>121-129</b>		12"	(30.5cm)
<b>121-128</b>		14"	(35.6cm)

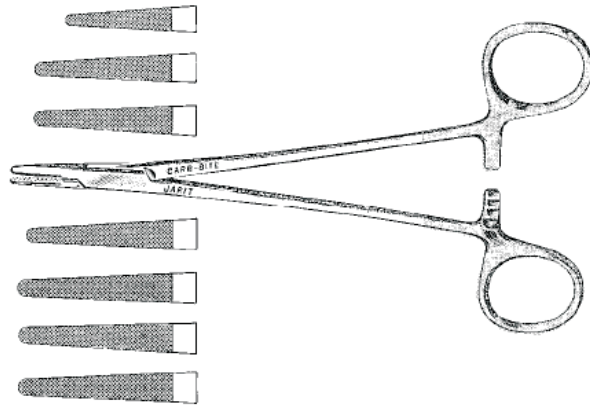

### MAYO-HEGAR Needle Holder

Satin	Matte		
<b>121-135</b>	<b>123-135</b>	6"	(15.2cm)
<b>121-140</b>	<b>123-140</b>	7"	(17.8cm)
<b>121-145</b>	<b>123-145</b>	8"	(20.3cm)
<b>121-146</b>		9"	(22.8cm)
<b>121-142</b>		10"	(25.4cm)
<b>121-143</b>		11"	(28cm)
<b>121-147</b>		12"	(30.5cm)
<b>121-144</b>		14"	(35.6cm)

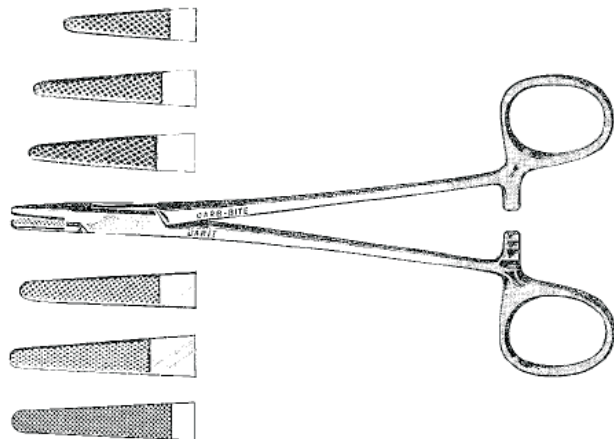

**JARIT** CARB-BITE NEEDLE HOLDERS

JARIT CARB-BITE Needle Holders feature jaw inserts of solid tungsten carbide. Sharply defined serrations have been milled into these inserts to provide a secure hold on the suture needle.

Because tungsten carbide is much harder than stainless steel, the useful life of CARB-BITE

Needle Holders greatly exceeds that of ordinary needle holders. JARIT CARB-BITE Needle Holders are guaranteed for a minimum of three years of normal usage. If jaw serrations should wear smooth while under guarantee, new CARB-BITE inserts will be installed without charge. Finger rings are gold plated for easy identification.

**PETIT-POINT OLSEN-HEGAR** Needle Holders,  
5" (12.7cm), delicate

- 121-148 Serrated
- 121-149 Smooth

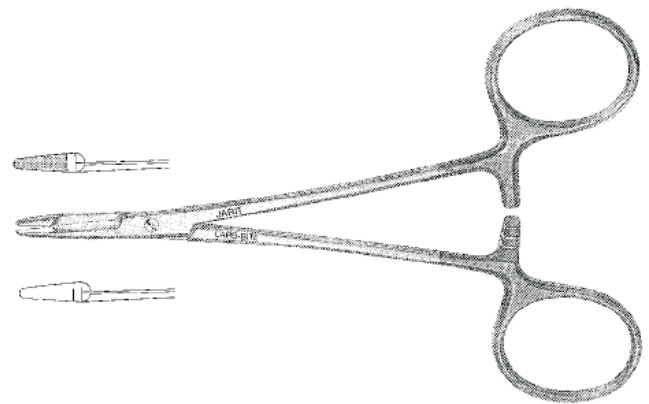

**OLSEN-HEGAR** Needle Holders

- 121-150 5 3/4" (14.6cm)
- 121-155 6 1/2" (16.5cm)

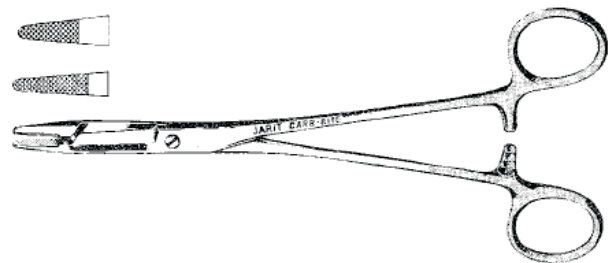

**RYDER** Needle Holders

- 121-160 5" (12.7cm)
- 121-161 6" (15.2cm)
- 121-162 7" (17.8cm)
- 121-163 8" (20.3cm)
- 121-164 9" (22.8cm)
- 121-165 10" (25.4cm)

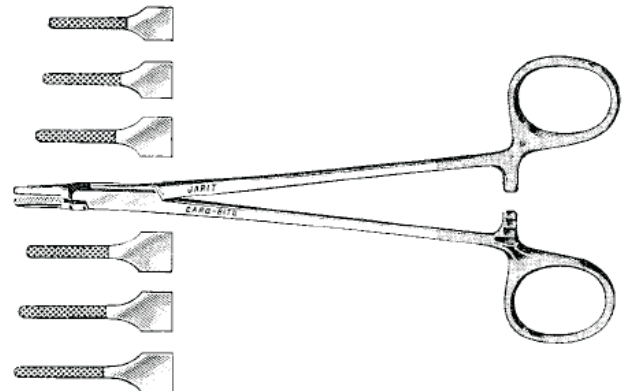

## JARIT CARB-BITE NEEDLE HOLDERS

JARIT CARB-BITE Needle Holders feature jaw inserts of solid tungsten carbide. Sharply defined serrations have been milled into these inserts to provide a secure hold on the suture needle.

Because tungsten carbide is much harder than stainless steel, the useful life of CARB-BITE

Needle Holders greatly exceeds that of ordinary needle holders. JARIT CARB-BITE Needle Holders are guaranteed for a minimum of three years of normal usage. If jaw serrations should wear smooth while under guarantee, new CARB-BITE inserts will be installed without charge. Finger rings are gold plated for easy identification.

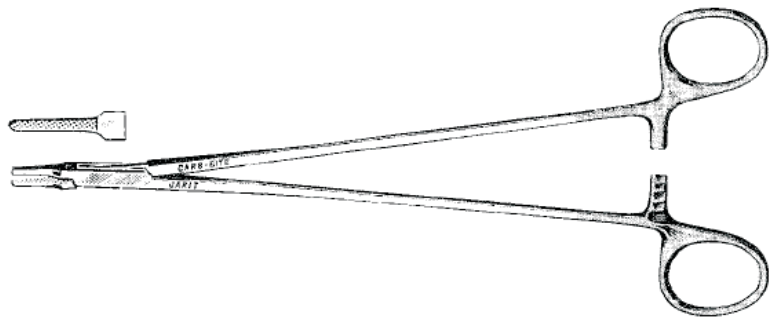

**121-166 HUFNAGEL-RYDER** Needle Holder,  
9" (22.8cm)

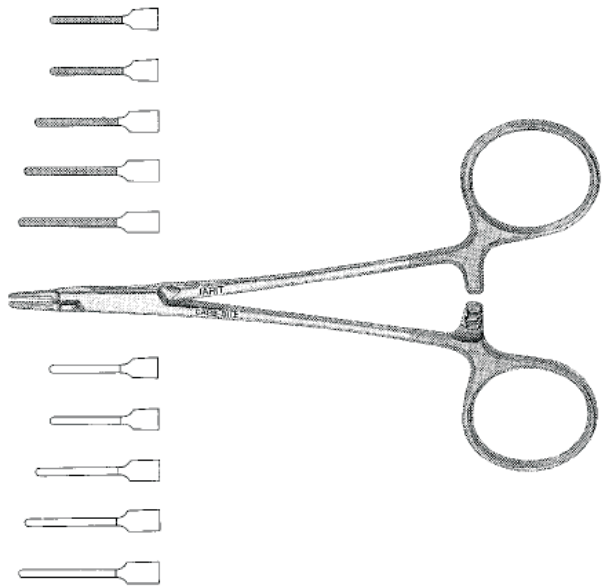

**PETIT-POINT RYDER** Needle Holders,  
1mm jaws

- 121-170** 5" (12.7cm), serrated
- 121-171** 5" (12.7cm), smooth
- 121-172** 6" (15.2cm), serrated
- 121-173** 6" (15.2cm), smooth
- 121-174** 7" (17.8cm), serrated
- 121-175** 7" (17.8cm), smooth
- 121-176** 8" (20.3cm), serrated
- 121-179** 8" (20.3cm), smooth
- 121-177** 9" (22.8cm), serrated
- 121-178** 9" (22.8cm), smooth

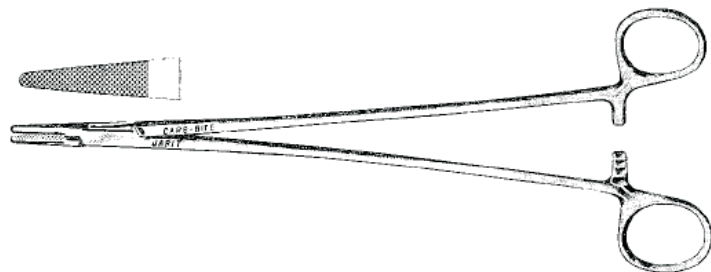

**121-180 MASSON** Needle Holder,  
10½" (26.6cm)

## JARIT CARB-BITE NEEDLE HOLDERS

JARIT CARB-BITE Needle Holders feature jaw inserts of solid tungsten carbide. Sharply defined serrations have been milled into these inserts to provide a secure hold on the suture needle.

Because tungsten carbide is much harder than stainless steel, the useful life of CARB-BITE

Needle Holders greatly exceeds that of ordinary needle holders. JARIT CARB-BITE Needle Holders are guaranteed for a minimum of three years of normal usage. If jaw serrations should wear smooth while under guarantee, new CARB-BITE inserts will be installed without charge. Finger rings are gold plated for easy identification.

### JARIT Microvascular Needle Holders

- 121-181 7" (17.8cm)
- 121-182 8" (20.3cm)
- 121-183 9" (22.8cm)

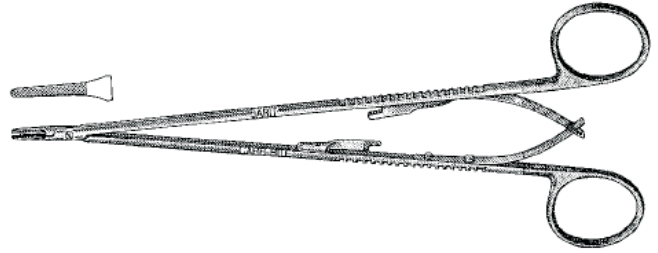

### DeBAKEY Vascular Needle Holders, extra light model

- 121-184 6" (15.2cm)
- 121-185 7" (17.8cm)
- 121-186 8" (20.3cm)
- 121-187 9" (22.8cm)
- 121-188 10½" (26.6cm)
- 121-189 12" (30.5cm)

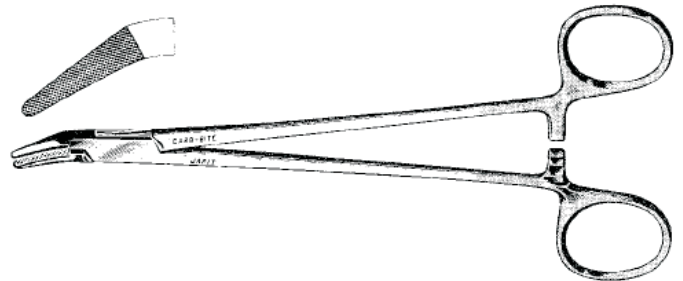
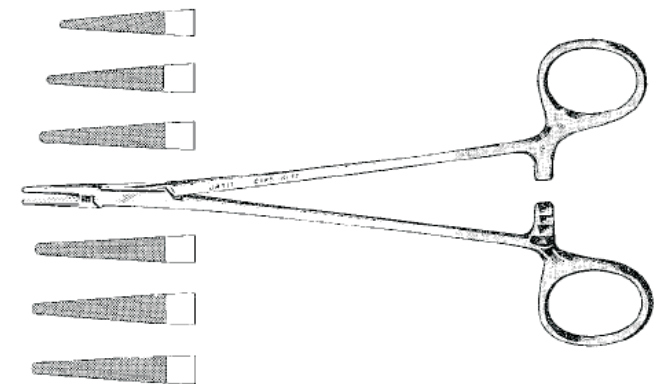

- 121-192 **FINOCHIETTO** Needle Holder, 10½" (26.6cm)

## JARIT CARB-BITE NEEDLE HOLDERS

JARIT CARB-BITE Needle Holders feature jaw inserts of solid tungsten carbide. Sharply defined serrations have been milled into these inserts to provide a secure hold on the suture needle.

Because tungsten carbide is much harder than stainless steel, the useful life of CARB-BITE

Needle Holders greatly exceeds that of ordinary needle holders. JARIT CARB-BITE Needle Holders are guaranteed for a minimum of three years of normal usage. If jaw serrations should wear smooth while under guarantee, new CARB-BITE inserts will be installed without charge. Finger rings are gold plated for easy identification.

**121-193 DeBAKEY Needle Holder,**  
9" (22.8cm), curved,  
extra light model

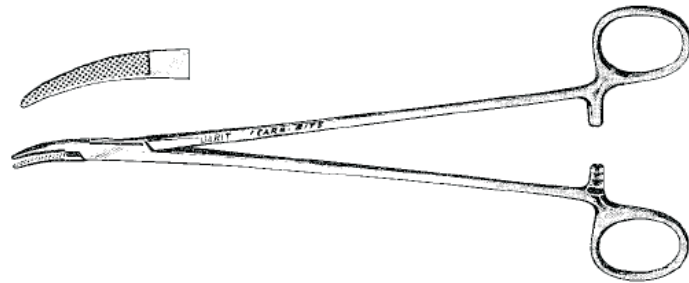

**121-195 STRATTE Needle Holder,**  
9" (22.8cm), double curved

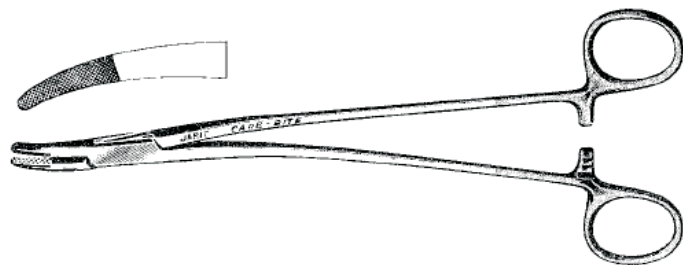

**PETIT-POINT SAROT Needle Holders,**  
delicate

**121-197** 6" (15.2cm)

**121-198** 6½" (16.8cm)

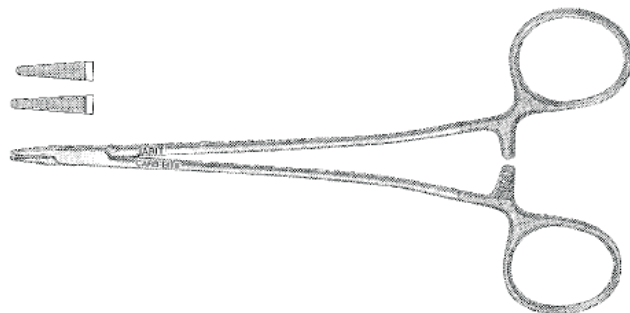



**JARIT CARB-BITE NEEDLE HOLDERS**

JARIT CARB-BITE Needle Holders feature jaw inserts of solid tungsten carbide. Sharply defined serrations have been milled into these inserts to provide a secure hold on the suture needle.

Because tungsten carbide is much harder than stainless steel, the useful life of CARB-BITE

Needle Holders greatly exceeds that of ordinary needle holders. JARIT CARB-BITE Needle Holders are guaranteed for a minimum of three years of normal usage. If jaw serrations should wear smooth while under guarantee, new CARB-BITE inserts will be installed without charge. Finger rings are gold plated for easy identification.

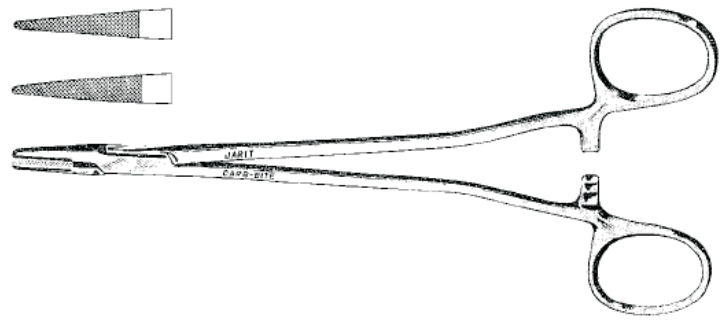

**SAROT** Needle Holders

- 121-200 7 $\frac{1}{8}$ " (18.1cm)
- 121-205 10 $\frac{1}{8}$ " (25.7cm)

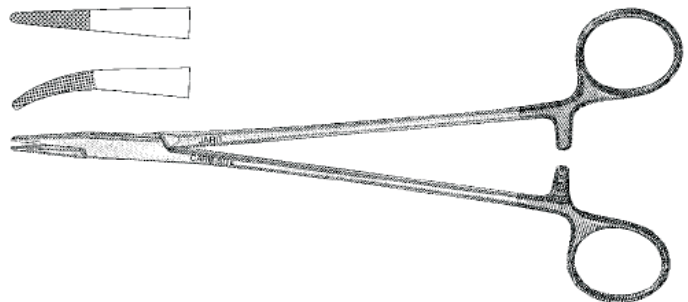

**JULIAN** Needle Holders,  
8 $\frac{1}{4}$ " (21cm)

- 121-206 Straight
- 121-207 Curved

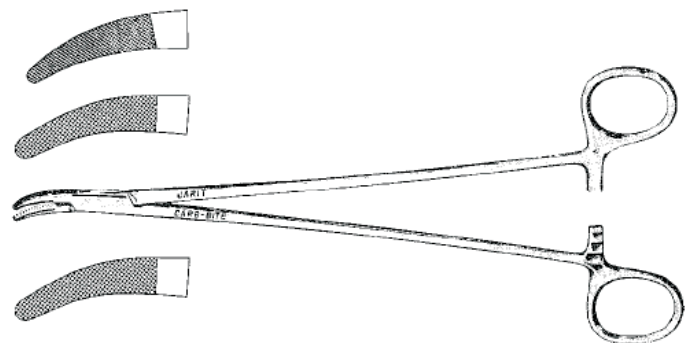

**HEANEY** Needle Holders,  
curved

- 121-210 8 $\frac{1}{4}$ " (21cm)
- 121-209 10" (25.4cm)
- 121-204 12" (30.5cm)



**JARIT CARB-BITE NEEDLE HOLDERS**

**JARIT** Vascular Needle Holders,  
light weight model, slender jaws

- 121-211 6" (15.2cm)
- 121-212 7¼" (18.4cm)
- 121-213 8" (20.3cm)
- 121-214 9" (22.8cm)
- 121-215 10" (25.4cm)

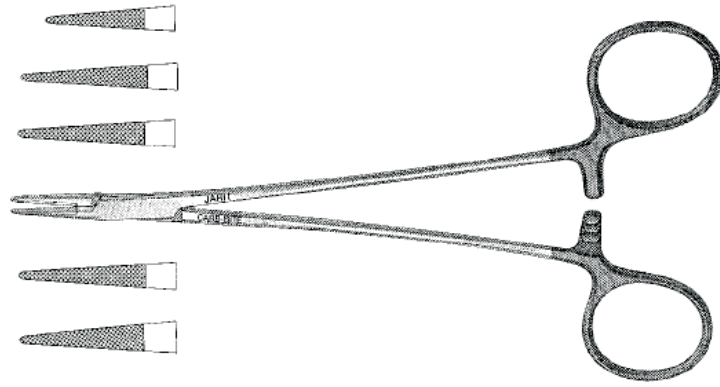

**JARIT** Intracardiac Needle Holders

- 121-216 7" (17.8cm)
- 121-217 8" (20.3cm)
- 121-218 9" (22.9cm)
- 121-219 10¼" (26cm)

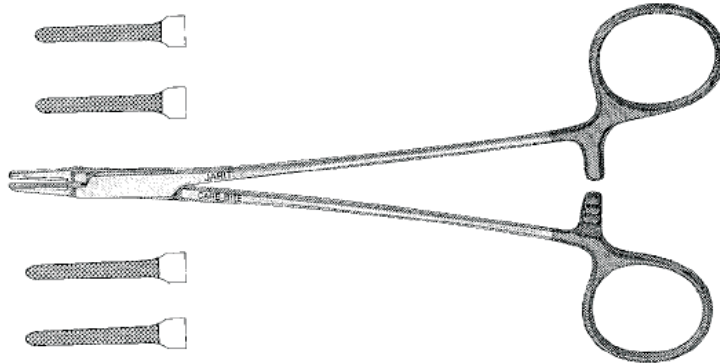

- 121-220 **MATHIEU** Needle Holder,  
8" (20.3cm)

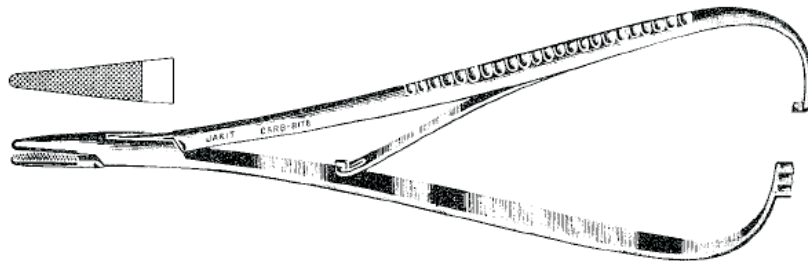

**JARIT** Microsurgical Needle Holders  
With Lock

- 121-228 7" (17.8cm), smooth jaws
- 121-229 7" (17.8cm), serrated jaws
- 121-230 8½" (21.6cm), smooth jaws
- 121-231 8½" (21.6cm), serrated jaws

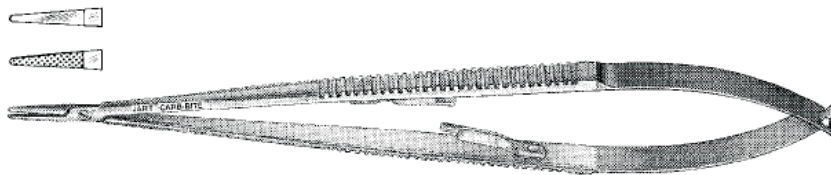

Without Lock

- 121-228NL 7" (17.8cm), smooth jaws
- 121-229NL 7" (17.8cm), serrated jaws
- 121-230NL 8½" (21.6cm), smooth jaws
- 121-231NL 8½" (21.6cm), serrated jaws

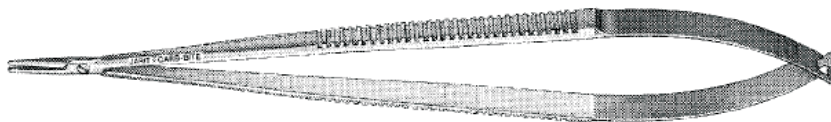

**JARIT** CARB-BITE NEEDLE HOLDERS AND WIRE TWISTERS

**121-250** JARIT Sternal Needle Holder and Wire Twisters,  
CARB-BITE jaws  
5" (12.7cm)

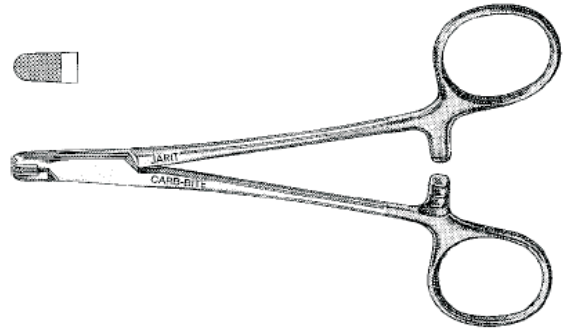

**121-255** JARIT Sternal Needle Holder and Wire Twister,  
7" (17.8cm)

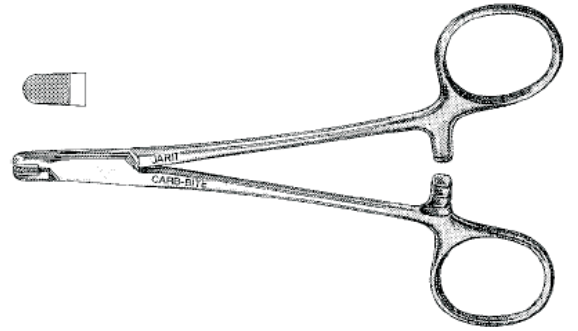

JARIT Wire Twister,  
6" (15.2cm)  
**121-257** Short delicate jaws  
**121-258** Short blunt jaws

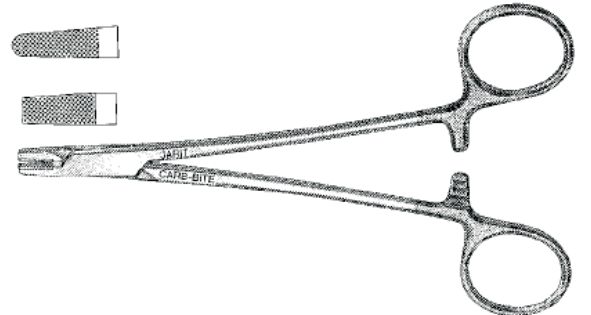

**121-260** JARIT Sternal Needle Holder and Wire Twister,  
7½" (18.4cm), heavy duty,  
5mm jaws

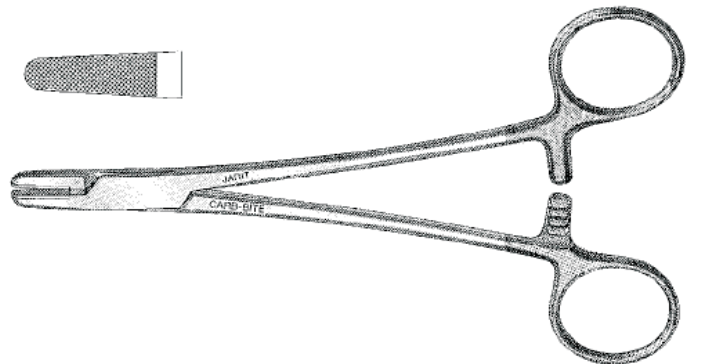

**JARIT** CARB-BITE TISSUE AND NEEDLE FORCEPS

These versatile forceps feature tips with solid tungsten carbide inserts. Fine, sharply defined serrations have been milled into these inserts

to provide non-slip surfaces for grasping tissue and suture needles. Handles are gold plated for easy identification.

**ADSON** Needle Forceps,  
1 x 2 teeth

- 122-500 4 3/4" (12.1cm)
- 122-501 4 3/4" (12.1cm), delicate
- 122-502 6" (15.2cm)
- 122-503 6" (15.2cm), delicate

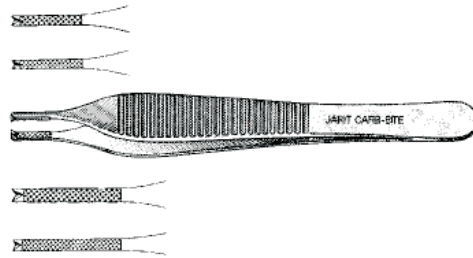

122-510 **BROWN-ADSON** Needle Forceps,  
4 3/4" (12.1cm), 3 x 4 teeth

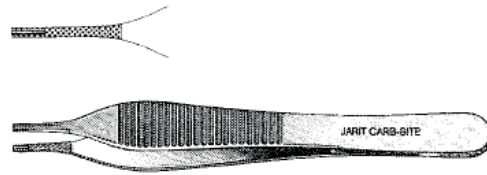

122-520 **BONNEY** Needle Forceps,  
6 3/4" (17.1cm), 1 x 2 teeth

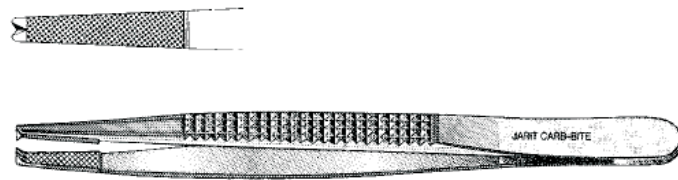

122-530 **CUSHING** Needle Forceps,  
7" (17.8cm), Gutsch handle,  
scraper end

122-535 Delicate

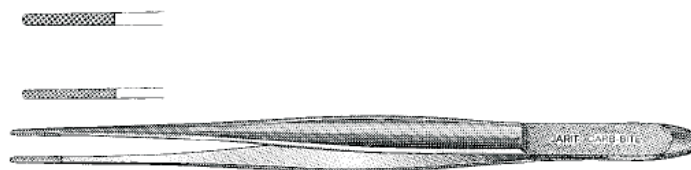

**JARIT** CARB-BITE TISSUE AND NEEDLE FORCEPS

These versatile forceps feature tips with solid tungsten carbide inserts. Fine, sharply defined serrations have been milled into these inserts

to provide non-slip surfaces for grasping tissue and suture needles. Handles are gold plated for easy identification.

**DeBAKEY** Needle Forceps,  
3 x 6 teeth, 2.0mm tips

- 122-540 6" (15.2cm)
- 122-542 7¼" (19.7cm)
- 122-544 9½" (24.1cm)

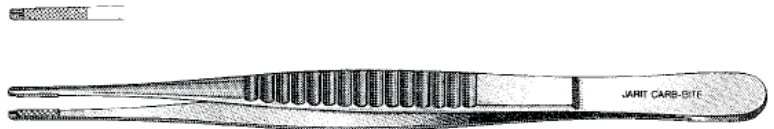

**DeBAKEY** Needle Forceps,  
2 x 4 teeth, 1.5mm tips

- 122-541 6" (15.2cm)
- 122-543 7¼" (19.7cm)
- 122-545 9½" (24.1cm)



- 122-550 **FERRIS-SMITH** Needle Forceps,  
6¾" (17.1cm), 1 x 2 teeth

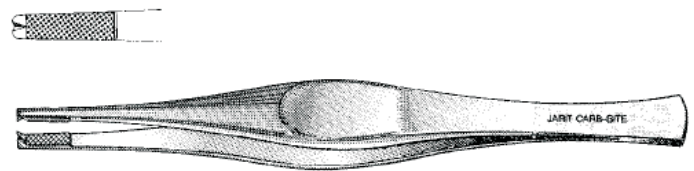

- 122-560 **JARIT** Needle Forceps,  
6¼" (16cm), 1 x 2 teeth

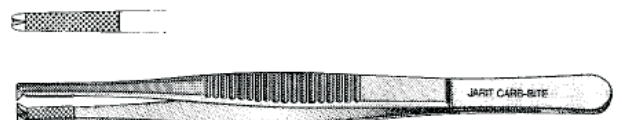

**JARIT CARB-BITE TISSUE AND NEEDLE FORCEPS**

These versatile forceps feature tips with solid tungsten carbide inserts. Fine, sharply defined serrations have been milled into these inserts

to provide non-slip surfaces for grasping tissue and suture needles. Handles are gold plated for easy identification.

**122-570 GERALD Needle Forceps,**  
7" (17.8cm), 1 x 2 teeth, delicate

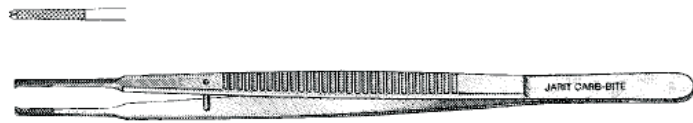

**122-590 SEMKEN Needle Forceps,**  
6" (15.2cm), 1 x 2 teeth



**122-591 Delicate**

**122-600 SKINNER Needle Forceps,**  
9" (22.8cm), 1 x 2 teeth

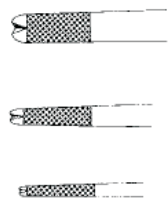

**122-601 Delicate**  
**122-602 Micro**



**125-100** **HEGENBARTH** Clip Applying Forceps,  
5" (12.7cm)



**125-110** **MICHEL** Clip Applying/Removing Forceps,  
5" (12.7cm), double ended

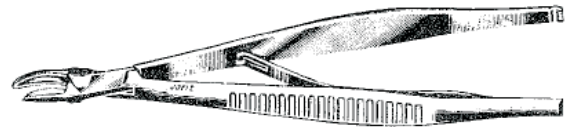

**MICHEL** Skin Clips,  
package of 1000

- 125-114** 7.5mm
- 125-115** 11mm
- 125-117** 14mm
- 125-120** 16mm
- 125-122** 18mm



**Jarvis** CARB-BITE TISSUE AND NEEDLE FORCEPS

125-125 RICHTER-HEATH Clip Forceps,  
5 1/4" (13.3cm)

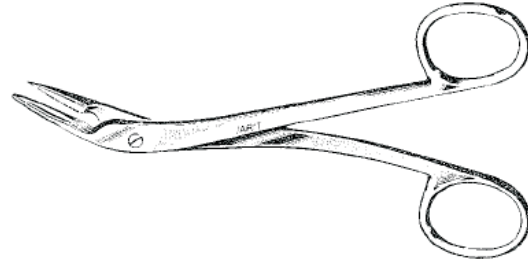

125-130 WACHTENFELD Clip Forceps,  
5" (12.7cm)



125-132 WACHTENFELD Clip Forceps,  
5" (12.7cm), cross-action

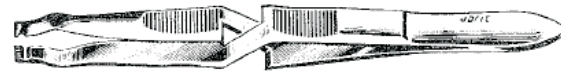

**DESCHAMPS** Ligature Carriers,  
8" (20.3cm)

- 125-150 Sharp, left
- 125-152 Sharp, right
- 125-154 Blunt, left
- 125-155 Blunt, right

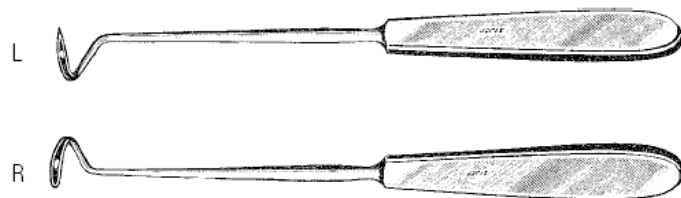

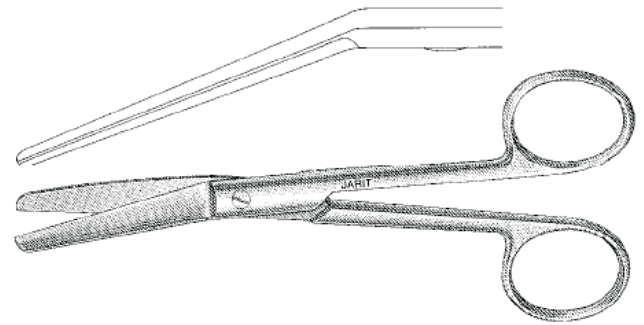

**125-165** **NEW'S** Suture Scissors,  
5½" (14cm), angled on flat

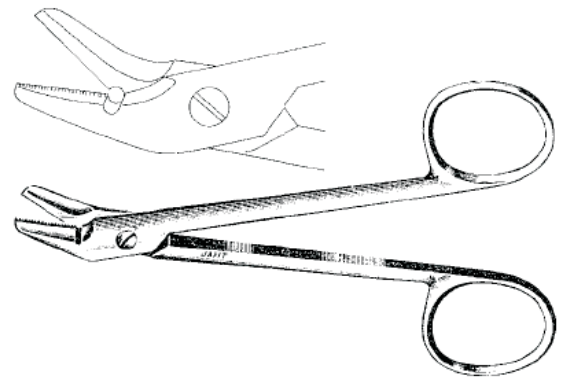

**125-170** **WIRE** Suture Scissors,  
4¾" (12.1cm), angled,  
one serrated blade

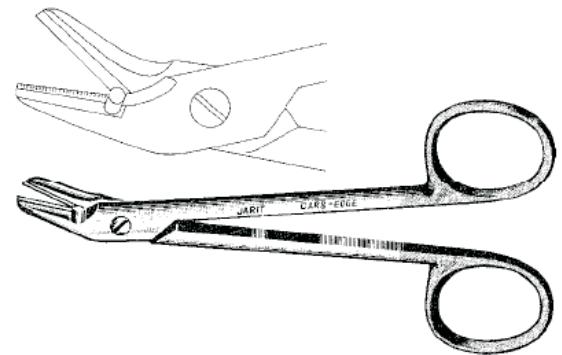

**101-350** **WIRE** Suture Scissors,  
4¾" (12.1cm), angled with CARB-EDGE blades,  
for cutting suture and wire (26 gauge and smaller)



**125-175** **HEATH** Suture Scissors,  
6 $\frac{3}{4}$ " (15.9cm), serrated

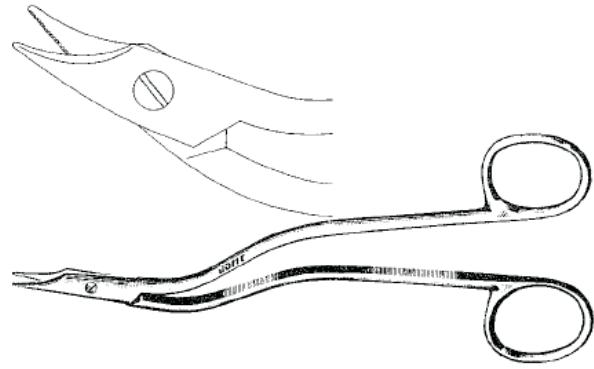

**125-180** **SPENCER** Suture Scissors  
3 $\frac{1}{2}$ " (8.9cm)  
**125-182** 4 $\frac{3}{4}$ " (12.1cm)

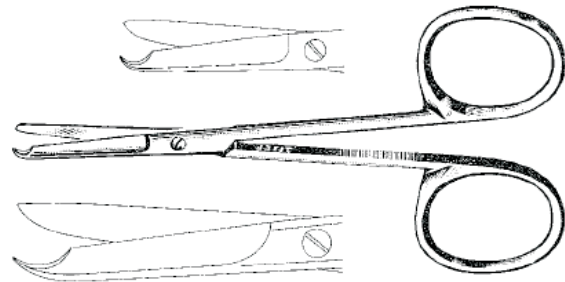

**125-184** **SPENCER** Suture Scissors,  
curved sideways  
3 $\frac{1}{2}$ " (8.9cm)  
**125-185** 4 $\frac{3}{4}$ " (12.1cm)

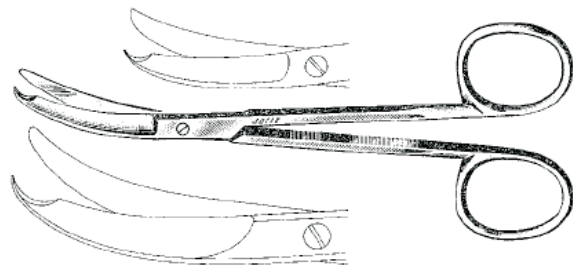

**125-190** **LITTAUER** Stitch Scissors,  
5 $\frac{1}{2}$ " (14cm)

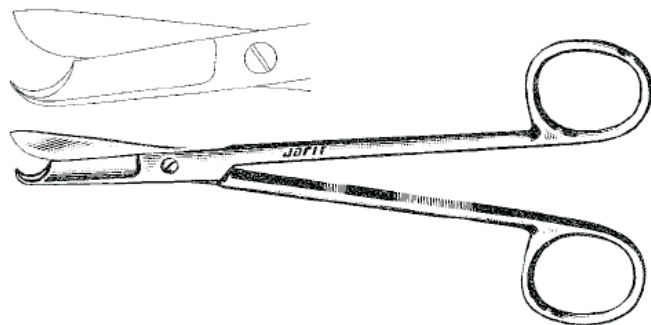

**JARIT** Suture Wire Scissors,  
4" (10.1cm), serrated

**125-192** Straight

**125-193** Curved

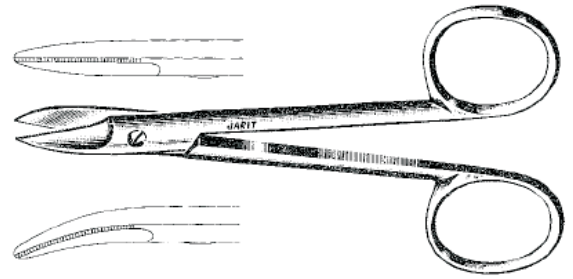

**125-194** **SMITH** Wire Scissors,  
6 3/4" (17.1cm)

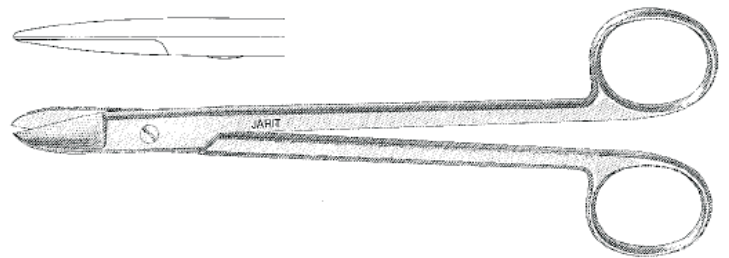

**125-195** **O'BRIEN** Suture Scissors,  
3 3/4" (9.5cm), angled

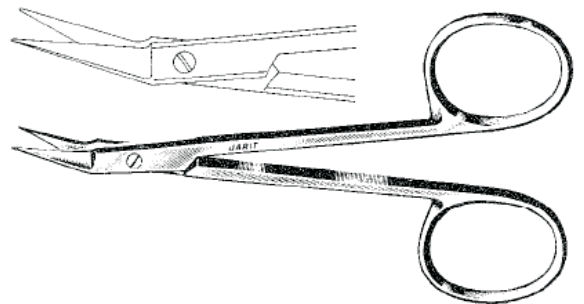

**THUMB** Forceps,  
serrated

Matte	Mirror	
130-099		4" (10.1cm)
130-100		4½" (11.4cm)
130-101		4½" (11.4cm), fluted handles
130-105		5" (12.7cm)
130-110	129-110	5½" (14cm)
130-111		5½" (14cm), fluted handles
130-115	129-115	6" (15.2cm)
130-116		6" (15.2cm), fluted handles
130-117		7" (17.8cm)
130-120		8" (20.3cm)
130-125		10" (25.4cm)
130-130		12" (30.5cm)
130-132		14" (35.6cm)



130-145 **TISSUE** Forceps,  
6" (15.2cm), CARB-BITE tips

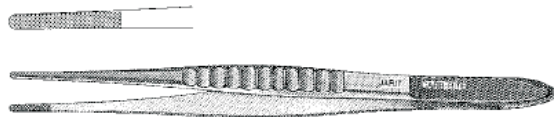

**TISSUE** Forceps,  
1 x 2 teeth

Matte	Mirror	
130-150		4½" (11.4cm)
130-151		4½" (11.4cm), fluted handles
130-155		5" (12.7cm)
130-160	129-160	5½" (14cm)
130-161		5½" (14cm), fluted handles
130-165	129-165	6" (15.2cm)
130-166		6" (15.2cm), fluted handles
130-167		7" (17.8cm)
130-170		8" (20.3cm)
130-175		10" (25.4cm)
130-180		12" (30.5cm)
130-182		14" (35.6cm)



130-185 **TISSUE** Forceps,  
6" (15.2cm), 1 x 2 teeth,  
cross serrated



**JARIT** DRESSING AND TISSUE FORCEPS

**TISSUE Forceps**

- 130-200 5½" (14cm), 2 x 3 teeth
- 130-201 6" (15.2cm), 2 x 3 teeth
- 130-210 5½" (14cm), 3 x 4 teeth
- 130-211 6" (15.2cm), 3 x 4 teeth
- 130-216 5½" (14cm), 4 x 5 teeth
- 130-217 6" (15.2cm), 4 x 5 teeth

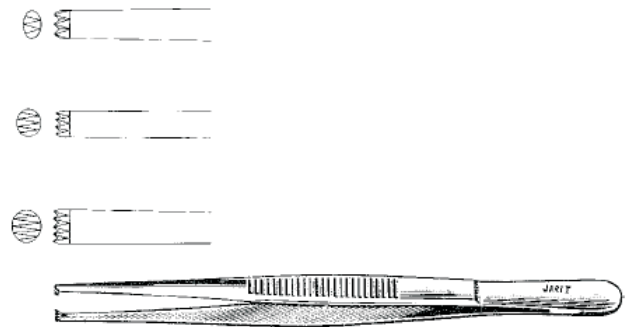

- 130-220 **VON GRAEFE** Tissue Forceps, 4½" (11.4cm)



- 130-225 **COLLEGE PLIERS #317**, 6" (15.2cm), serrated

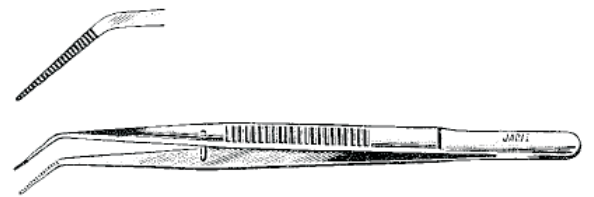

**ADSON Dressing Forceps, serrated**

- Matte     Mirror
- 130-230    129-230    4¾" (12.1cm)
- 130-231                    4¾" (12.1cm), extra delicate, 0.8mm wide tip



- 130-232 **ADSON Dressing Forceps**, 4¾" (12.1cm), cross serrated



**JARIT** DRESSING AND TISSUE FORCEPS

- ADSON** Tissue Forceps,  
1 x 2 teeth
- Matte Mirror
- 130-234 129-234 4 3/4" (12.1cm)
- 130-235 4 3/4" (12.1cm), extra delicate, 0.8mm wide tip
- 130-237 4 3/4" (12.1cm), angled
- 130-238 4 3/4" (12.1cm), with tying platform

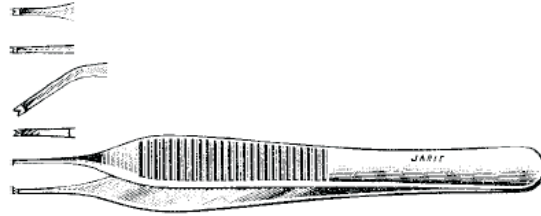

- 130-236 **ADSON** Tissue Forceps,  
4 3/4" (12.1cm), CARB-BITE tips

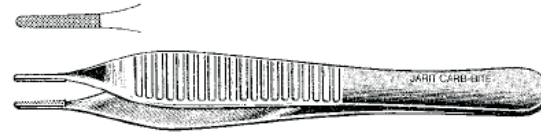

- 130-240 **ADSON** Tissue Forceps,  
4 3/4" (12.1cm), 2 x 3 teeth



- 130-243 **ADSON** Dressing Forceps,  
4 3/4" (12.1cm), cross serrated handle, matte
- 130-244 **ADSON** Tissue Forceps,  
4 3/4" (12.1cm), 1 x 2 teeth, cross serrated handle, matte

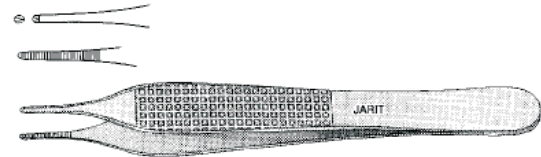

- 130-245 **ADSON** Tissue Forceps,  
4 3/4" (12.1cm), 1 x 2 teeth, serrated

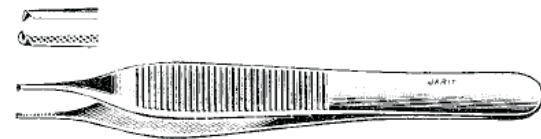

- 130-241 **ADSON** Tissue Forceps, delicate  
7" (17.8cm), 2 x 3 teeth, 3mm wide tip

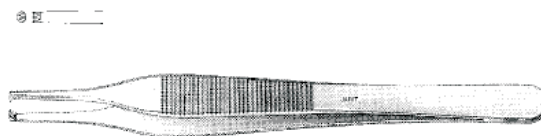

**Jarvis** DRESSING AND TISSUE FORCEPS

130-250 **EWALD (HUDSON)** Dressing Forceps,  
4 $\frac{1}{4}$ " (12.1 cm), serrated

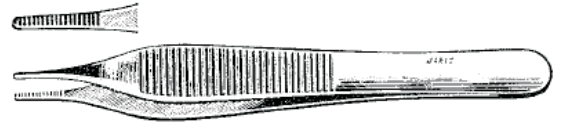

130-255 **EWALD (HUDSON)** Tissue Forceps,  
4 $\frac{1}{4}$ " (12.1 cm), 1 x 2 teeth



**BROWN-ADSON** Tissue Forceps,  
4 $\frac{1}{4}$ " (12.1 cm), 9 x 9 teeth

Satin Mirror  
130-260 129-260



130-262 **BEASLEY-BABCOCK** Tissue Forceps,  
5" (12.7 cm), 6 x 7 teeth

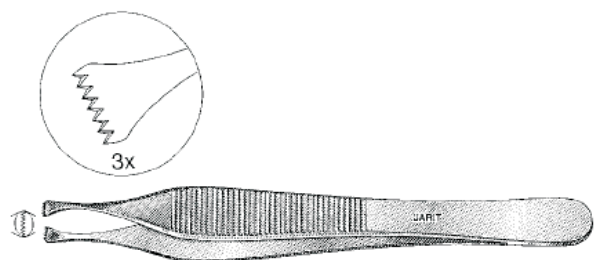

**JARIT** DRESSING AND TISSUE FORCEPS

**BROWN** Tissue Forceps,  
8 x 8 teeth

- 130-265 6" (15.2cm)
- 130-266 8" (20.3cm)
- 130-267 10" (25.4cm)



- 130-270 **BROWN-ADSON** Tissue Forceps,  
4 1/2" (12.1cm), 9 x 9 teeth, angled

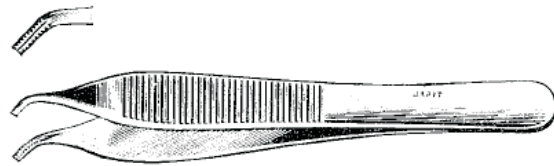

**SEMKEN** Dressing Forceps,  
serrated

- 130-275 4 1/2" (12.1cm)
- 130-276 6" (15.2cm)



**SEMKEN** Tissue Forceps

- 130-280 4 1/2" (12.1cm), 1 x 2 teeth
- 130-281 6" (15.2cm), 1 x 2 teeth
- 130-282 4 1/2" (12.1cm), 2 x 3 teeth



**JARIT** DRESSING AND TISSUE FORCEPS

**130-284** **McINDOE** Dressing Forceps,  
6" (15.2cm), serrated

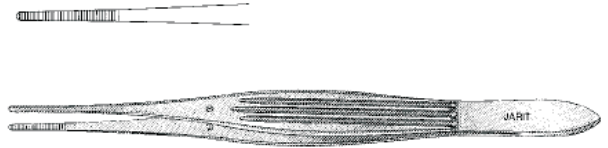

**130-286** **GILLIES** Tissue Forceps,  
6" (15.2cm), 1 x 2 teeth, cross-serrated

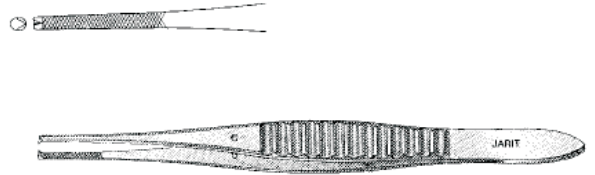

**130-287** **BRIGHTAM** Tissue Forceps,  
5½" (14cm), 1 x 2 teeth, dissecting end  
Tip width 2.2mm

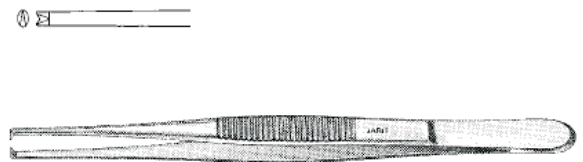

**FERRIS-SMITH** Tissue Forceps,  
6¾" (17.1cm)

**130-289** 1 x 2 teeth  
**130-290** 2 x 3 teeth

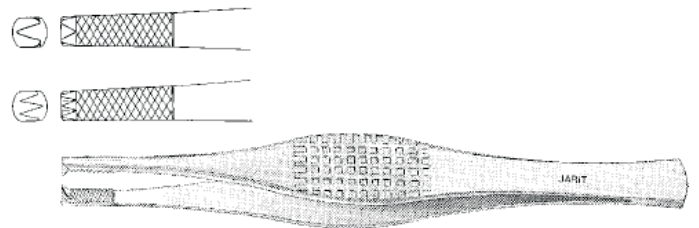



**JARIT** DRESSING AND TISSUE FORCEPS

**BONNEY** Tissue Forceps,  
6 $\frac{3}{4}$ " (17.1cm)

- 130-293 1 x 2 teeth
- 130-294 2 x 3 teeth

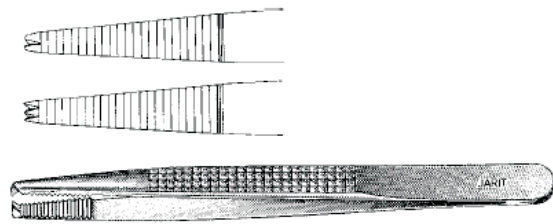

**WHEELER-Type** Plaque and Vessel Forceps,  
CARDIO-GRIP serrations

- 130-296 5 $\frac{1}{2}$ " (14cm)
- 130-297 7 $\frac{1}{4}$ " (18.4cm)
- 130-298 8 $\frac{3}{4}$ " (22.3cm)

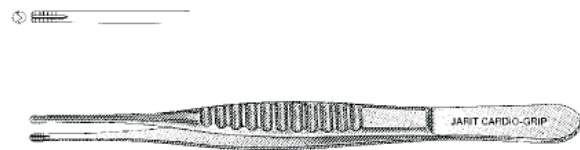

- 130-300 **ALDERKREUTZ** Tissue Forceps,  
6" (15.2cm), 6 x 6 teeth



**JARIT** DRESSING AND TISSUE FORCEPS

**POTTS-SMITH Dressing Forceps,**  
serrated

- 130-350** 7" (17.8cm)
- 130-355** 8¼" (21cm)
- 130-360** 9½" (24.1cm)
- 130-367** 10¼" (26cm)
- 130-365** 12" (30.5cm)

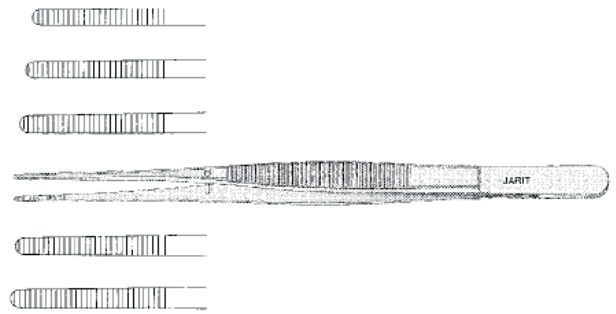

**POTTS-SMITH Tissue Forceps,**  
1 x 2 teeth, serrated

- 130-352** 7" (17.8cm)
- 130-357** 8¼" (21cm)
- 130-362** 9½" (24.1cm)
- 130-368** 10¼" (26cm)
- 130-366** 12" (30.5cm)

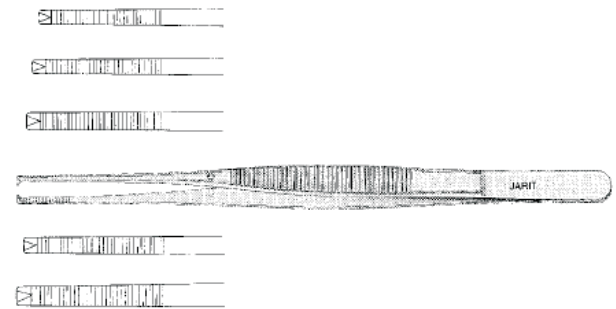

**POTTS-SMITH Tissue Forceps,**  
CARB-BITE tips

- 130-353** 7" (17.8cm)
- 130-358** 8¼" (21cm)
- 130-363** 9½" (24.1cm)
- 130-369** 10¼" (26cm)

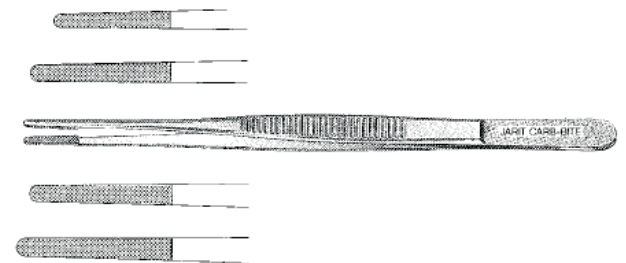

**NELSON** Tissue Forceps,  
6 x 7 teeth

- 130-370 6" (15.2cm)
- 130-375 7" (17.8cm)
- 130-380 9" (22.8cm)

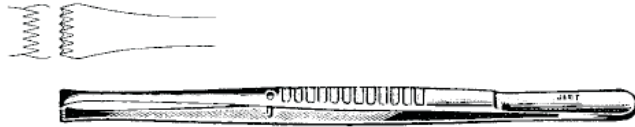

**130-383 EVANS** Tissue Forceps,  
10" (25.4cm), CARB-BITE tips

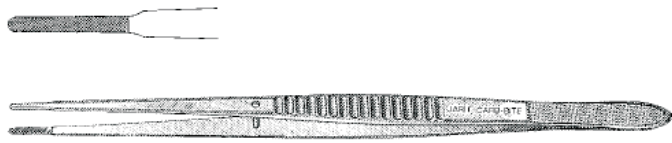

**RUSSIAN** Tissue Forceps

- | Mirror  | Matte   |              |
|---------|---------|--------------|
| 130-390 | 129-390 | 6" (15.2cm)  |
| 130-392 | 129-392 | 8" (20.3cm)  |
| 130-395 | 129-395 | 10" (25.4cm) |
| 130-394 |         | 12" (30.5cm) |
| 130-396 |         | 14" (35.6cm) |

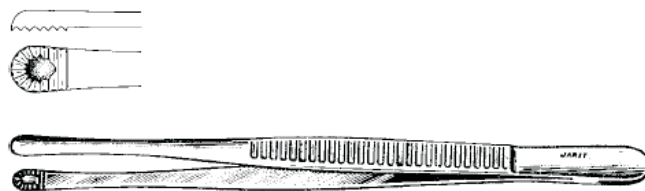

**130-397 MAYO-RUSSIAN** Tissue Forceps,  
9" (22.8cm)

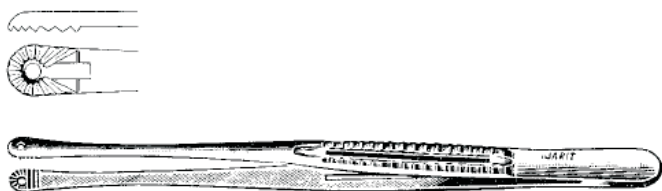

**JARIT** DRESSING AND TISSUE FORCEPS

**CUSHING** Dressing Forceps,  
straight, serrated, scraper end

- 130-400 6 $\frac{3}{4}$ " (17.1cm)
- 130-445 8" (20.3cm)

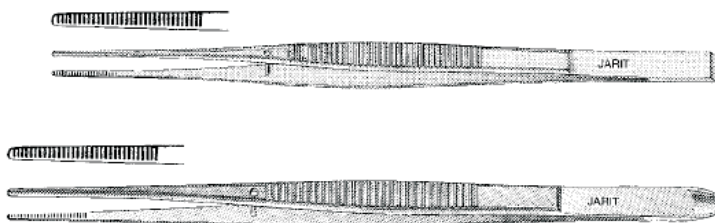

**CUSHING** Tissue Forceps,  
straight, 1 x 2 teeth, scraper end

- 130-405 7" (17.8cm)
- 130-446 8" (20.3cm), cross serrated

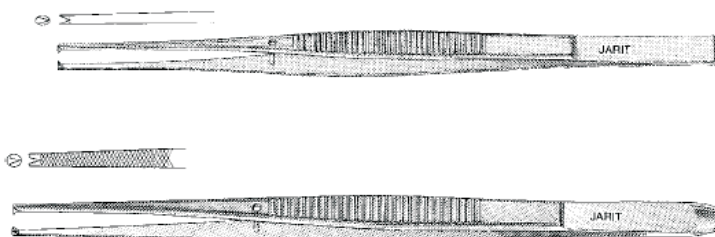

**CUSHING** Dressing Forceps,  
bayonet, serrated, scraper end

- 130-410 7 $\frac{1}{4}$ " (18.4cm)
- 130-420 7 $\frac{3}{4}$ " (19.7cm)

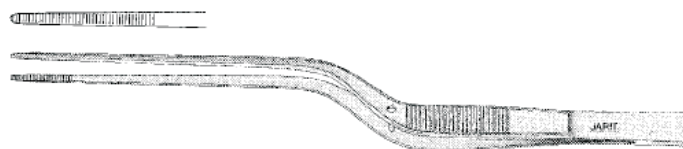

**CUSHING** Tissue Forceps,  
bayonet, 1 x 2 teeth, scraper end

- 130-415 7 $\frac{1}{4}$ " (18.4cm)
- 130-421 7 $\frac{3}{4}$ " (19.7cm)

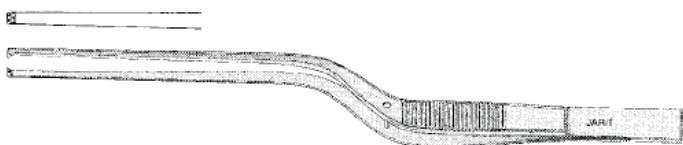

**CUSHING** Tissue Forceps,  
7" (17.8cm), Gutsch handle, straight,  
scraper end

- 130-425 Serrated
- 130-430 1 x 2 teeth
- 130-435 1 x 2 teeth, serrated



122-530 **CUSHING** Needle Forceps,  
7" (17.8cm), straight, CARB-BITE tips,  
Gutsch handle, scraper end

122-535 Delicate

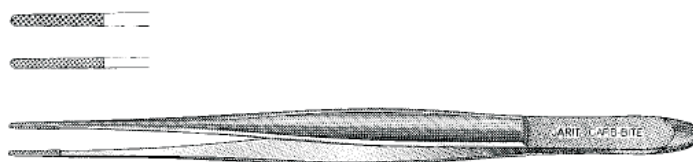

**JARIT** DRESSING AND TISSUE FORCEPS

**130-417 CUSHING** Tissue Forceps,  
7" (17.8cm), angled, CARB-BITE tips,  
Gutsch handle, scraper end

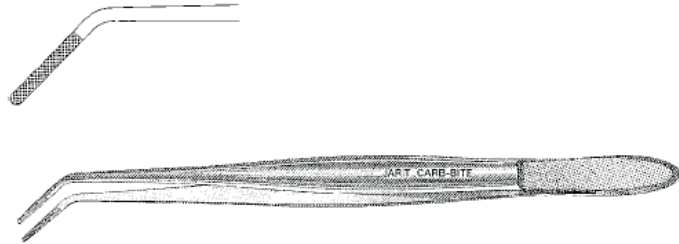

**130-418 CUSHING** Tissue Forceps,  
7 3/4" (19.7cm), bayonet,  
CARB-BITE tips, scraper end

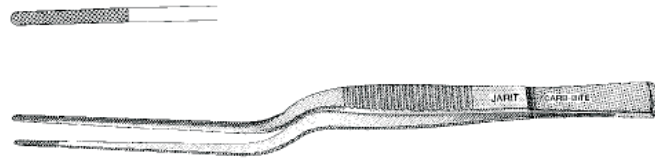

**130-437 REUL** Coronary Tissue Forceps,  
8" (20.3cm), delicate,  
CARB-BITE tips, 1.8mm wide



**130-440 CUSHING-BROWN** Tissue Forceps,  
7" (17.8cm), straight, double row  
of 9 x 9 delicate teeth, scraper end



**130-442 CUSHING-BROWN** Tissue Forceps,  
7 1/4" (18.4cm), bayonet, double row  
of 9 x 9 delicate teeth, scraper end



**Jarit** SPLINTER FORCEPS

**PLAIN** Splinter Forceps

130-500 3½" (8.9cm)

130-505 4½" (11.4cm)

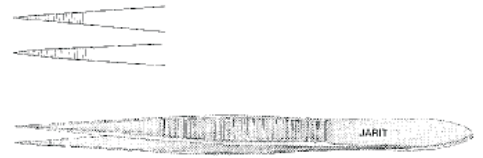

**FEILCHENFELD** Splinter Forceps

130-510 3" (7.6cm)

130-515 4½" (11.4cm)

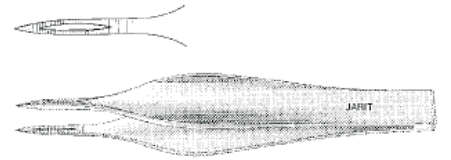

**CARMALT** Splinter Forceps,  
4½" (10.8cm)

130-520 Straight

130-525 Angled

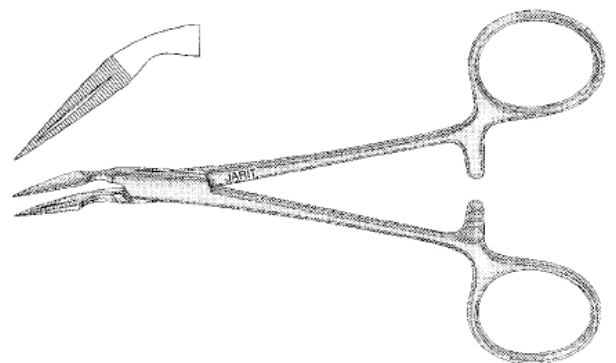
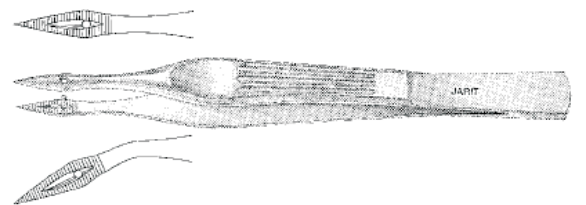

130-535 **WILLIAMS** Splinter Forceps,  
5½" (14cm), angled

**JART** **INTESTINAL TISSUE FORCEPS**

**135-095** **PETIT-POINT ALLIS** Tissue Forceps,  
5 1/4" (13.3cm), 4 x 5 teeth

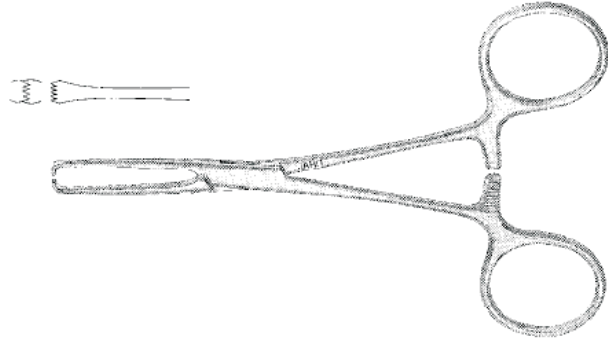

**ALLIS** Tissue Forceps,  
6" (15.2cm)

Mirror	Matte	
<b>135-100</b>	<b>136-100</b>	4 x 5 teeth
<b>135-105</b>	<b>136-105</b>	5 x 6 teeth

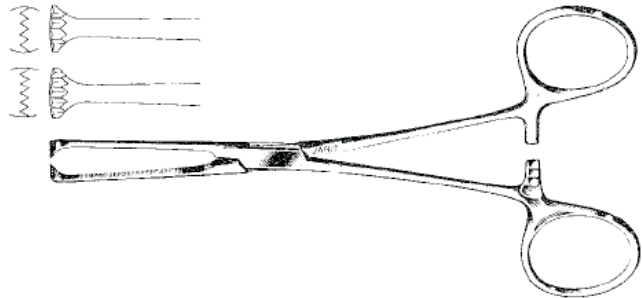

**ALLIS** Tissue Forceps,  
7 1/2" (19cm)

Mirror	Matte	
<b>135-110</b>	<b>136-110</b>	5 x 6 teeth
<b>135-111</b>		5 x 6 teeth, delicate

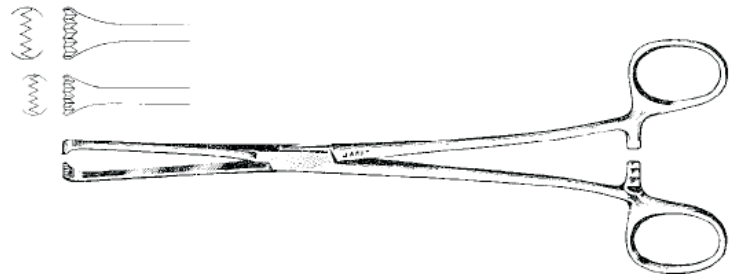

**Jarit** **INTESTINAL TISSUE FORCEPS**

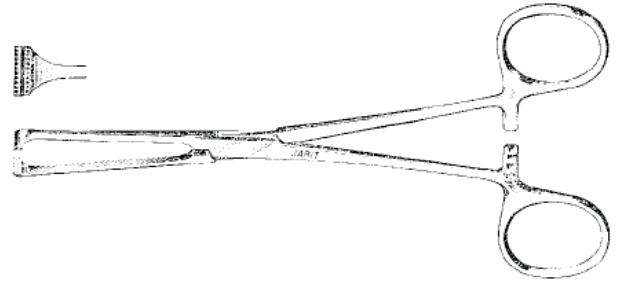

**135-107 JARIT-ALLIS** Tissue Forceps,  
6 $\frac{1}{4}$ " (16cm), 2 rows of fine, non-traumatic teeth

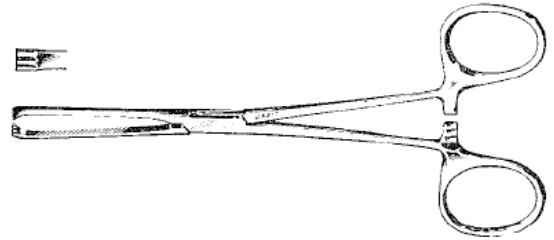

**JUDD-ALLIS** Tissue Forceps,  
3 x 4 teeth  
**135-115** 6" (15.2cm)  
**135-120** 7 $\frac{1}{2}$ " (19cm)

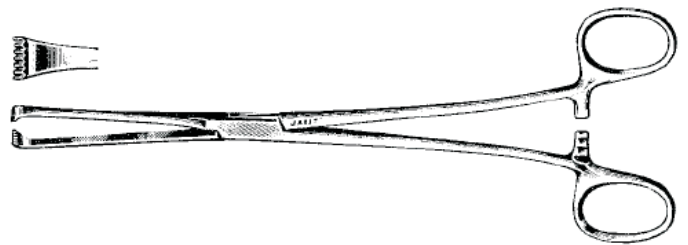

**135-125 THOMS-ALLIS** Tissue Forceps,  
8" (20.3cm), 6 x 7 teeth

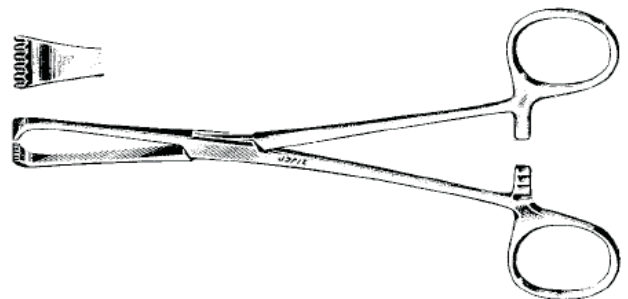

**135-127 BOYS-ALLIS** Tissue Forceps,  
6 $\frac{1}{4}$ " (16cm), 5 x 6 teeth



**JARVI** **INTESTINAL TISSUE FORCEPS**

**135-130 ALLIS-ADAIR** Tissue Forceps,  
6" (15.2cm), 9 x 10 teeth

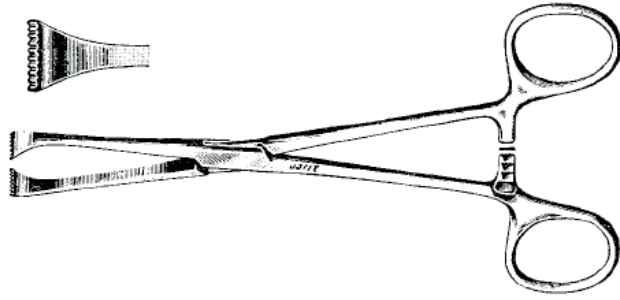

**135-135 LOCKWOOD-ALLIS** Tissue Forceps,  
6¼" (16cm)

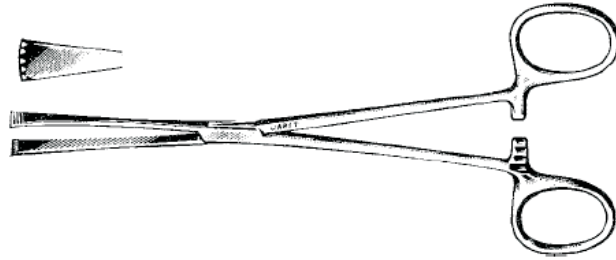

**COLLINS** Tissue Forceps,  
7¼" (19.7cm)

**135-150** Jaw width ½"

**135-155** Jaw width 1"

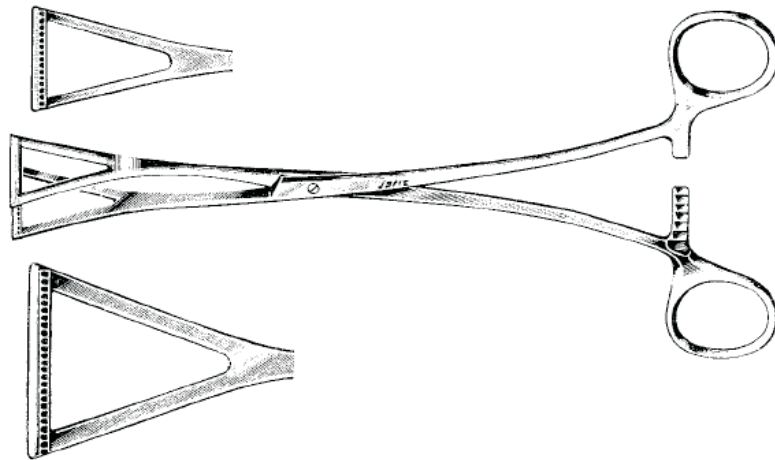

**135-175 WILLIAMS** Tissue Forceps,  
6½" (16.5cm)

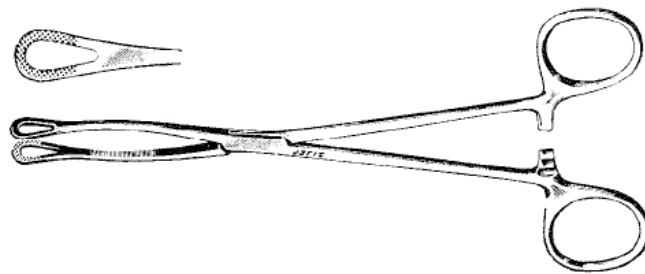

**JARIT** **INTESTINAL TISSUE FORCEPS**

**PETIT-POINT BABCOCK** Tissue Forceps

- 135-179 5¼" (14.6cm), jaw width 6mm
- 135-180 6¼" (16cm), jaw width 7.5mm

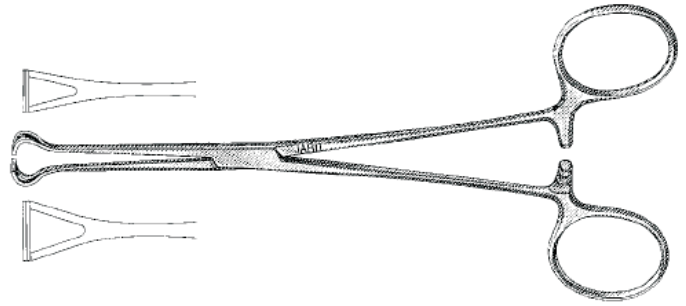

**BABCOCK** Tissue Forceps

- |         |         |                                |
|---------|---------|--------------------------------|
| Mirror  | Matte   |                                |
| 135-181 | 136-181 | 6¼" (16cm), jaw width 7.5mm    |
| 135-185 |         | 7¼" (18.4cm), jaw width 11mm   |
| 135-190 | 136-190 | 8" (20.3cm), jaw width 11mm    |
| 135-195 |         | 9½" (24.1cm), jaw width 11mm   |
| 135-196 |         | 12" (30.5cm), jaw width 11mm   |
| 135-194 |         | 14" (35.6cm), jaw width 11.3mm |

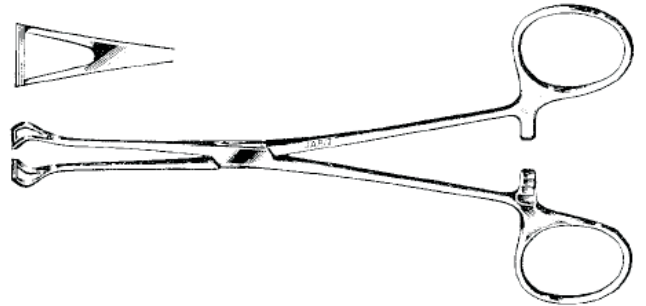

**BABCOCK** Tissue Forceps,  
CARB-BITE tips

- 135-182 6½" (16.5cm), jaw width 7.5mm
- 135-191 8" (20.3cm), jaw width 11mm

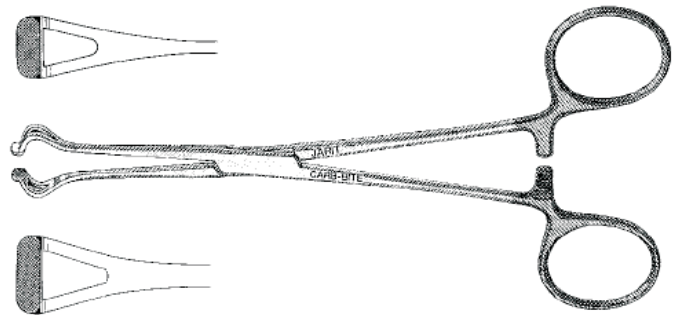

- 135-615 **BENSON** Pylorus Spreader,  
6¼" (16cm)

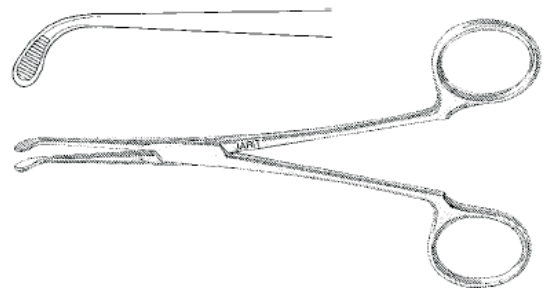

- 135-197 **ADAIR** Breast Clamp,  
7¼" (18.4cm)

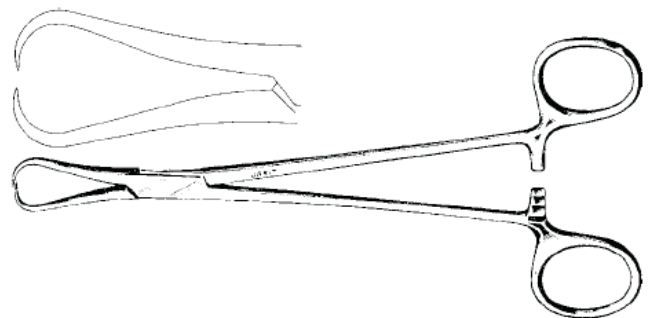

**SINGLEY** Tissue Forceps

135-250 9" (22.8cm)

135-248 14" (35.6cm)

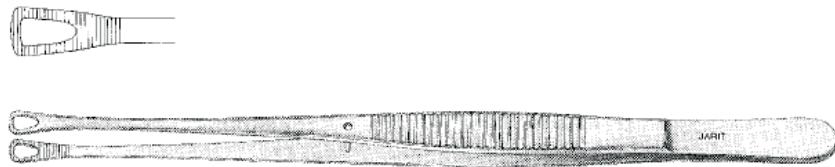

**SELMAN** Tissue Forceps,  
round cup with teeth

135-252 6" (15.2cm)

135-253 8" (20.3cm)

135-254 10" (25.4cm)

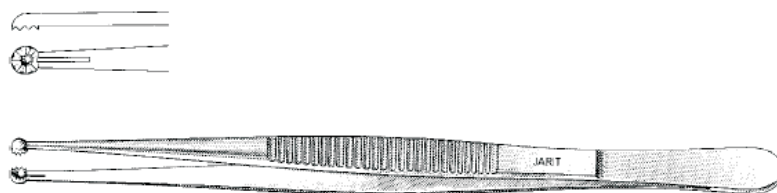

**WANGENSTEEN** Tissue Forceps,  
CARB-BITE tips

135-256 6" (15.2cm)

135-257 9" (22.8cm)

135-258 10" (25.4cm)

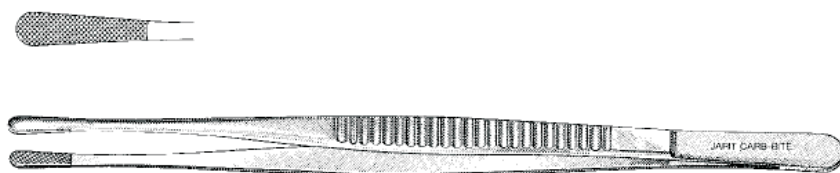

## JARIT® INTESTINAL INSTRUMENTS

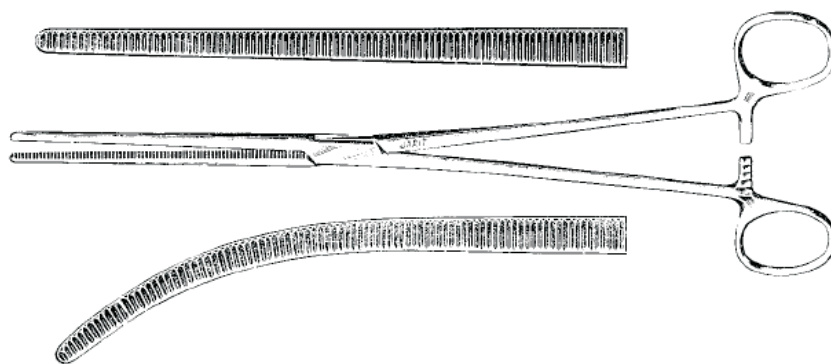

**PEAN** Forceps,  
horizontal serrations

- 135-260 10" (25.4cm), straight, jaw length 3½" (8.9cm)
- 135-261 10" (25.4cm), curved, jaw length 3½" (8.9cm)
- 135-262 11" (27.9cm), straight, jaw length 3½" (8.9cm)
- 135-265 11" (27.9cm), curved, jaw length 3½" (8.9cm)
- 135-263 12" (30.5cm), straight, jaw length 3½" (8.9cm)
- 135-266 12" (30.5cm), curved, jaw length 3½" (8.9cm)
- 135-264 14" (35.6cm), straight, jaw length 3½" (8.9cm)
- 135-267 14" (35.6cm), curved, jaw length 3½" (8.9cm)

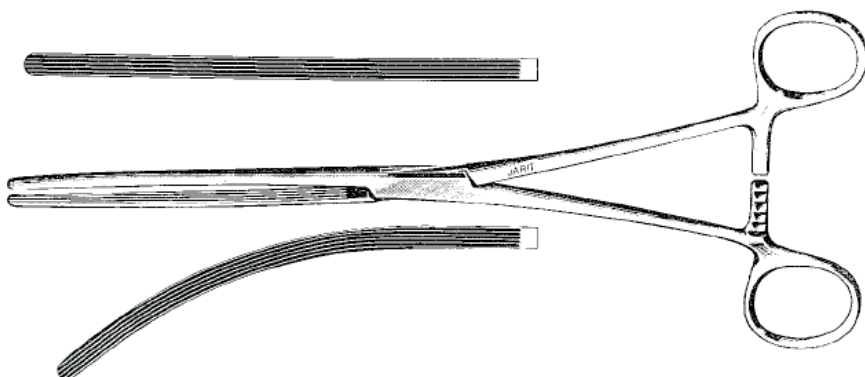

**PEAN** Forceps,  
longitudinal serrations

- 135-270 8" (20.3cm), straight, jaw length 2½" (6.3cm)
- 135-271 8" (20.3cm), curved, jaw length 2¾" (6cm)
- 135-275 9" (22.9cm), straight, jaw length 3" (7.6cm)
- 135-276 9" (22.9cm), curved, jaw length 2¾" (7.3cm)
- 135-280 10" (25.4cm), straight, jaw length 3½" (8.9cm)
- 135-281 10" (25.4cm), curved, jaw length 3¾" (8.6cm)

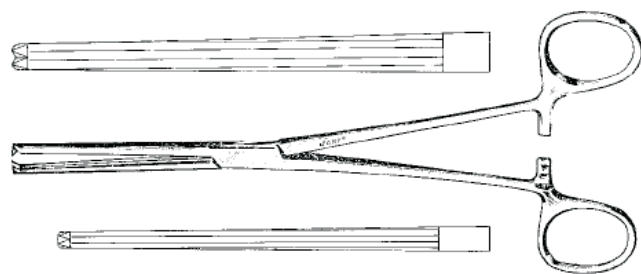

**ALLEN** Intestinal Clamps,  
longitudinal serrations, 1 x 2 teeth

- 135-300 8" (20.3cm), jaw length 2¾" (6cm)
- 135-301 6¼" (16cm), jaw length 2½" (5.4cm), pediatric

**JART** **INTESTINAL INSTRUMENTS**

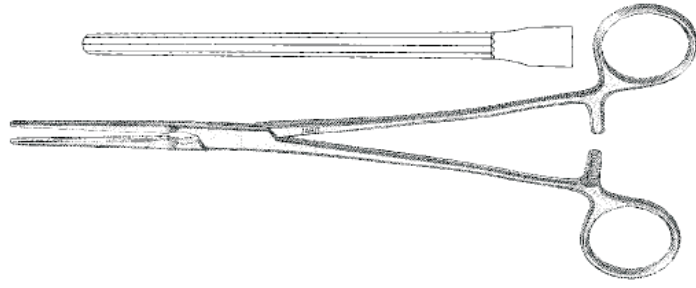

**135-305 DENNIS** Anastomosis Clamp,  
9 $\frac{1}{4}$ " (23.5cm), jaw length 2 $\frac{1}{8}$ " (5.2cm)

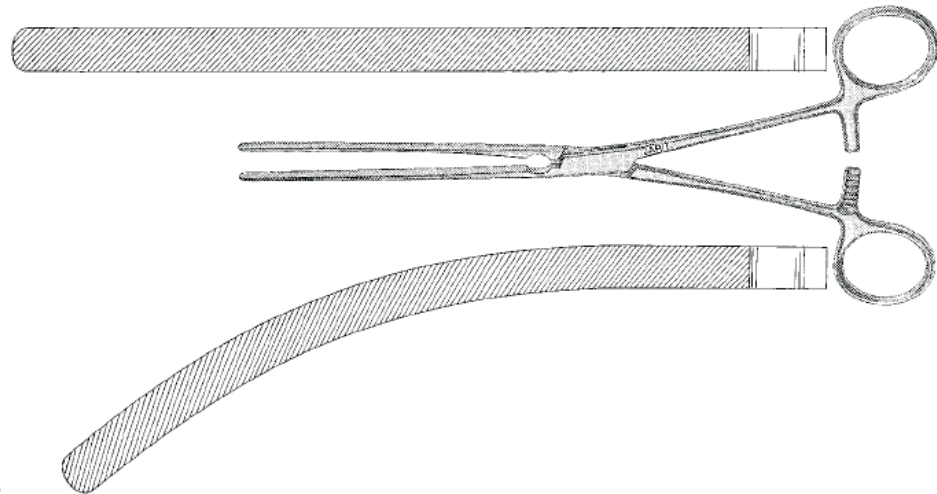

**DOYEN** Intestinal Clamps,  
9" (22.9cm), jaw length 3 $\frac{3}{4}$ " (9.5cm),  
diagonal serrations

- 135-350** Straight
- 135-355** Curved

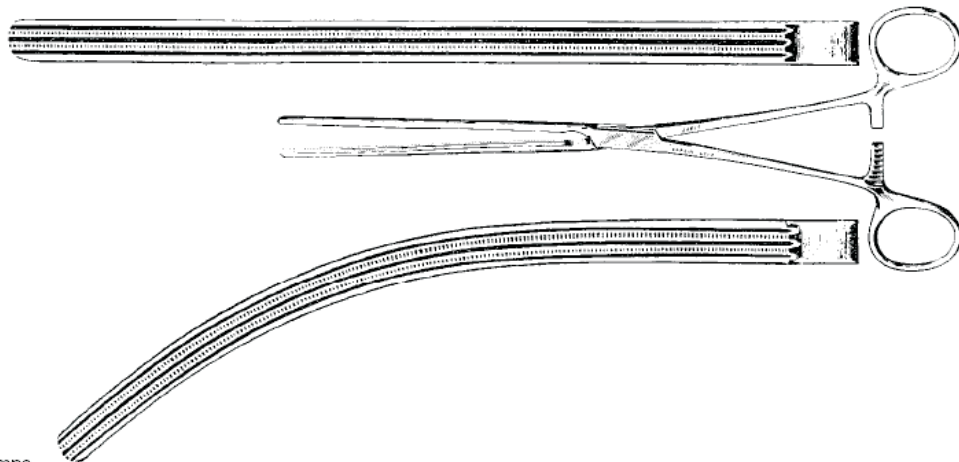

**DOYEN** Intestinal Clamps,  
9 $\frac{1}{2}$ " (24.1cm), jaw length 3 $\frac{3}{8}$ " (9.8cm),  
CARDIO-GRIP jaws

- 325-150** Straight
- 325-151** Curved

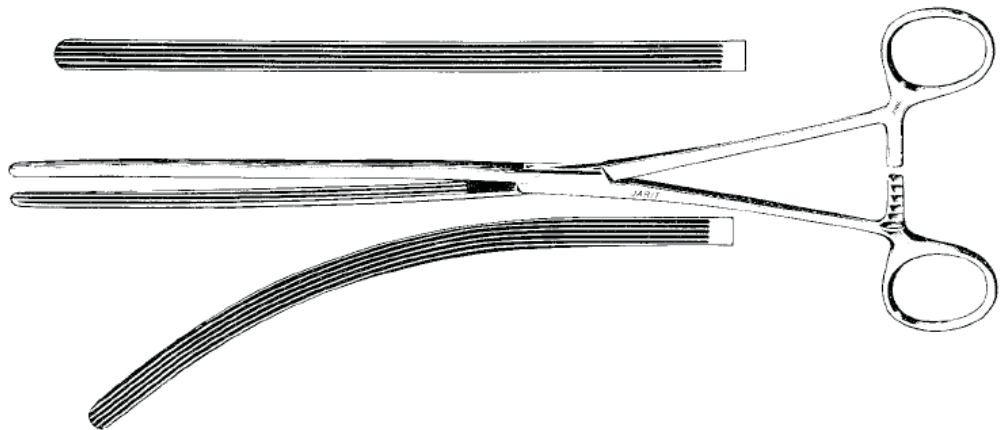

**MAYO-ROBSON** Intestinal Forceps,  
jaw length 4 $\frac{1}{8}$ " (12.4cm), longitudinal serrations

- 135-370 9 $\frac{3}{4}$ " (24.8cm), straight
- 135-375 9 $\frac{1}{2}$ " (24.1cm), curved

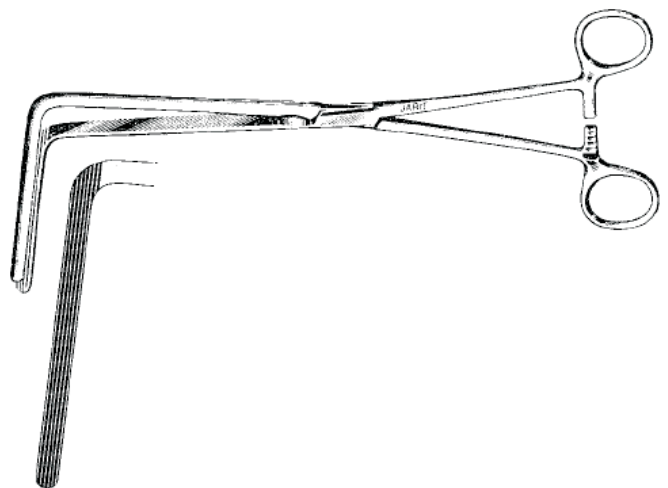

135-400 **FEHLAND** Intestinal Clamp,  
10" (25.4cm), jaw length 3 $\frac{1}{4}$ " (8.2cm)

**STONE** Intestinal Clamp,  
with locking device

- 135-430 3" (7.6cm)
- 135-435 4" (10.2cm)



- 135-440 **STONE** Clamp Locking Device



- 135-445 **STONE** Clamp Applying Forceps,  
6 1/4" (15.9cm)

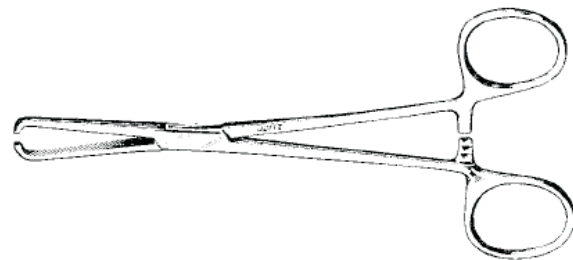

**STONE** Intestinal Clamp Set

Includes:

- 2 applying forceps
- 2 intestinal clamps
- 2 locking devices

- 135-450 3" (7.6cm) clamp set
- 135-451 4" (10.2cm) clamp set

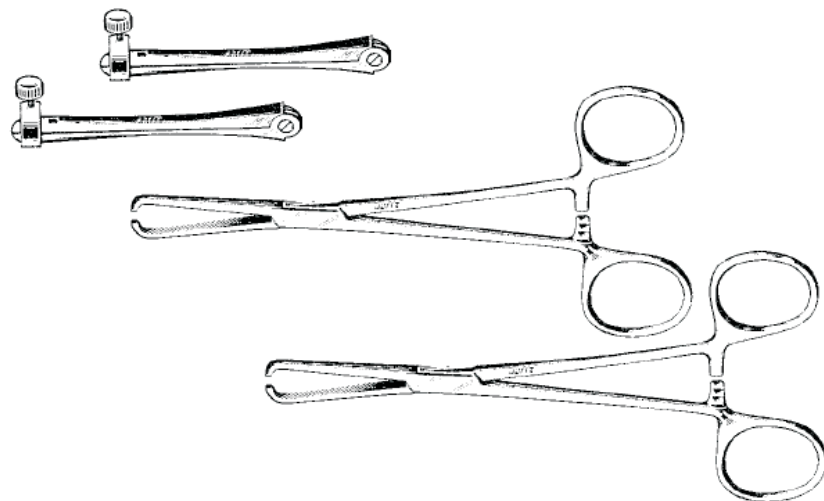

**JARIT** INTESTINAL INSTRUMENTS

**135-500** DEMARTEL-WOLFSON Closing Forceps,  
9 $\frac{3}{4}$ " (24.8cm)

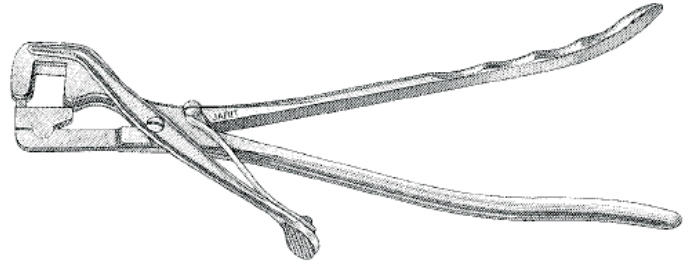

**135-502** DEMARTEL-WOLFSON Clamp Holder,  
3 $\frac{3}{4}$ " (8.3cm)

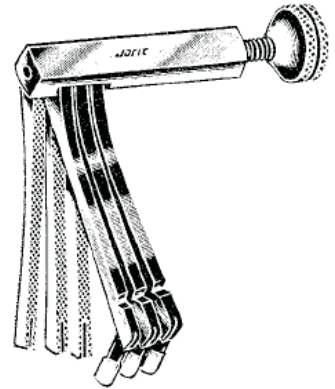

**135-504** DEMARTEL-WOLFSON Clamp Holder,  
9" (22.9cm)



**DEMARTEL-WOLFSON** Clamps,  
set of 3

**135-505** 2" (5.1cm)

**135-506** 3" (7.6cm)

**135-507** 4" (10.2cm)

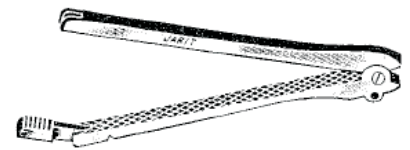

**135-598** PAYR Pylorus Clamp,  
6" (15.2cm), pediatric,  
jaw length 2 $\frac{1}{4}$ " (5.4cm)

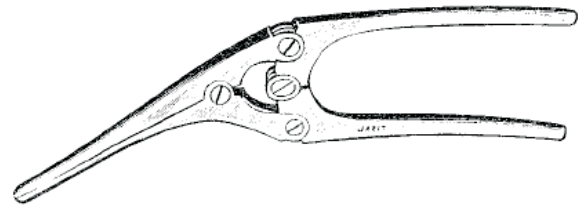

**PAYR** Pylorus Clamps

**135-600** 8" (20.3cm), jaw length 2 $\frac{3}{8}$ " (6cm)

**135-605** 11" (28cm), jaw length 4 $\frac{1}{4}$ " (10.8cm)

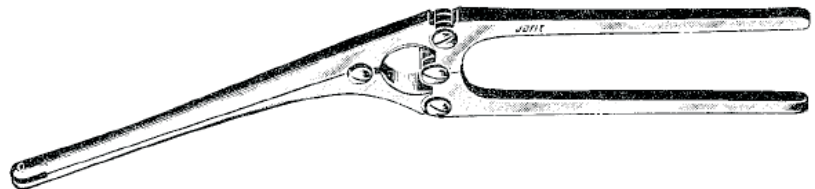



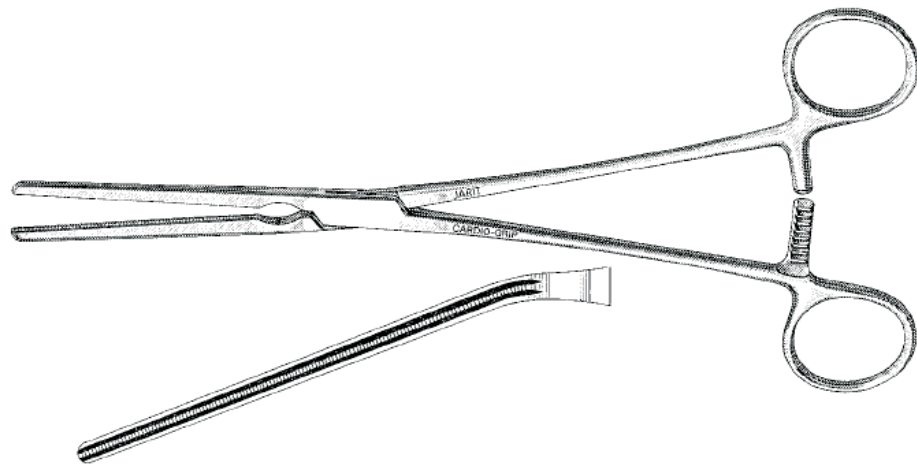

JARIT Intestinal Clamps,  
CARDIO-GRIP jaws

- 325-140 9¼" (23.5cm) straight, jaw length 2¾" (7cm)
- 325-141 9" (22.9cm) angled 25°, jaw length 3" (7.5cm)

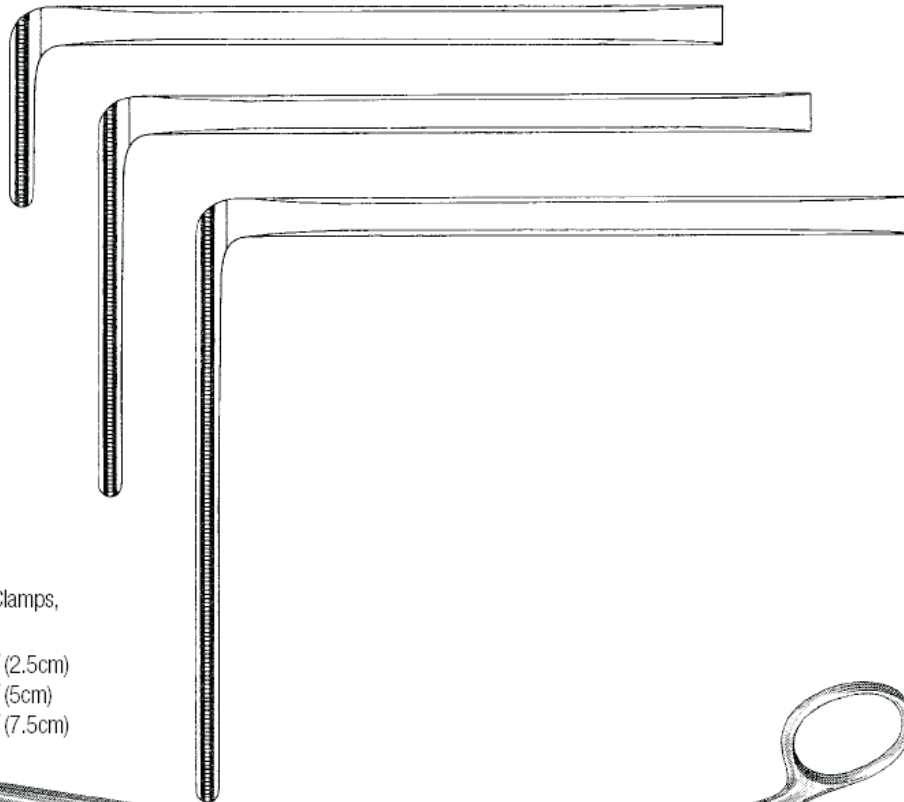

JARIT Anterior Resection Clamps,  
CARDIO-GRIP jaws

- 325-142 10" (25.4cm), jaw length 1" (2.5cm)
- 325-143 10" (25.4cm), jaw length 2" (5cm)
- 325-144 10" (25.4cm), jaw length 3" (7.5cm)

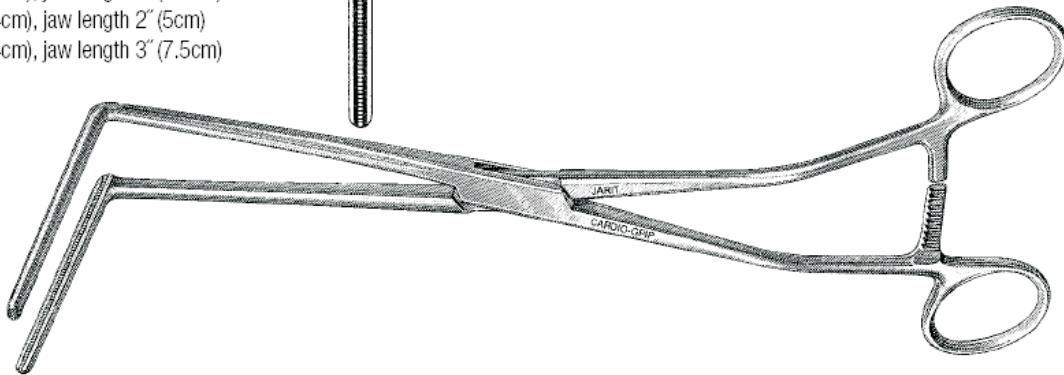

- 320-340 Hausmann Clamp, 12mm**  
8" (20.3cm), straight shanks
- 320-341 Hausmann Clamp, 18mm**  
8" (20.3cm), straight shanks
- 320-342 Hausmann Clamp, 25mm**  
8" (20.3cm), straight shanks
- 320-343 Hausmann Clamp, 30mm**  
8" (20.3cm), straight shanks

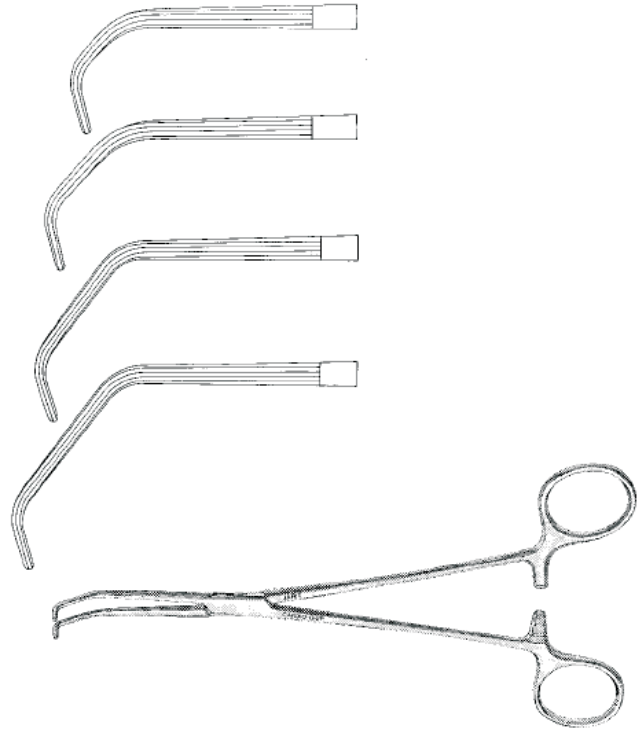

- 320-344 Hausmann Clamp, 12mm**  
8" (20.3cm), angled shanks
- 320-345 Hausmann Clamp, 18mm**  
8" (20.3cm), angled shanks
- 320-346 Hausmann Clamp, 25mm**  
8" (20.3cm), angled shanks
- 320-347 Hausmann Clamp, 30mm**  
8" (20.3cm), angled shanks

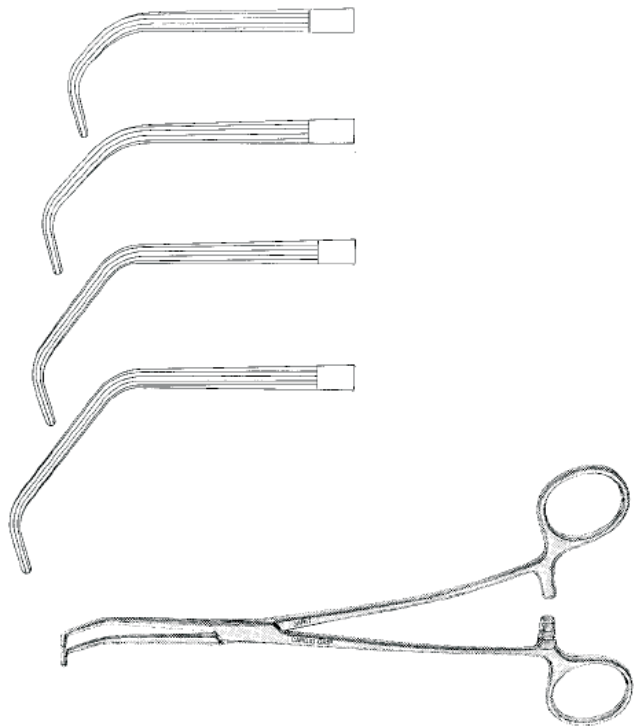

- 320-350 **Hausmann Clamp**, straight jaws  
8½" (21.5cm), straight shanks
- 320-351 **Hausmann Clamp**, 12mm curved jaws  
8" (21.5cm), straight shanks
- 320-352 **Hausmann Clamp**, spoon jaws  
8" (21.5cm), straight shanks

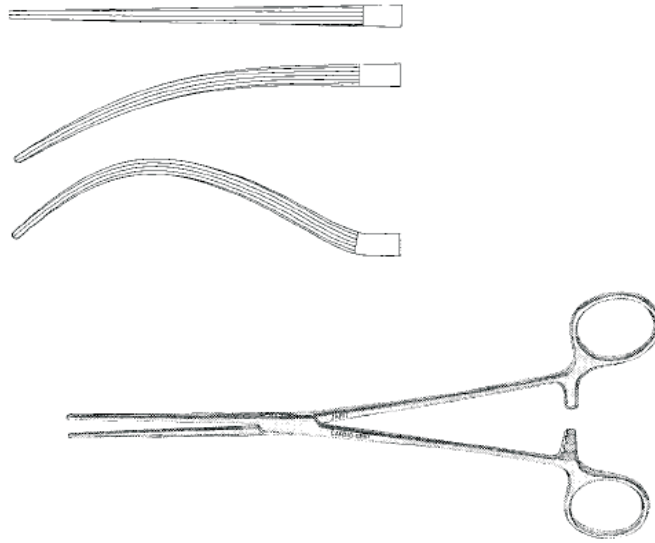

- 320-353 **Hausmann Clamp**, straight jaws  
8" (21.5cm), angled shanks
- 320-354 **Hausmann Clamp**, curved jaws  
8" (21.5cm), angled shanks
- 320-355 **Hausmann Clamp**, spoon jaws  
8" (21.5cm), angled shanks

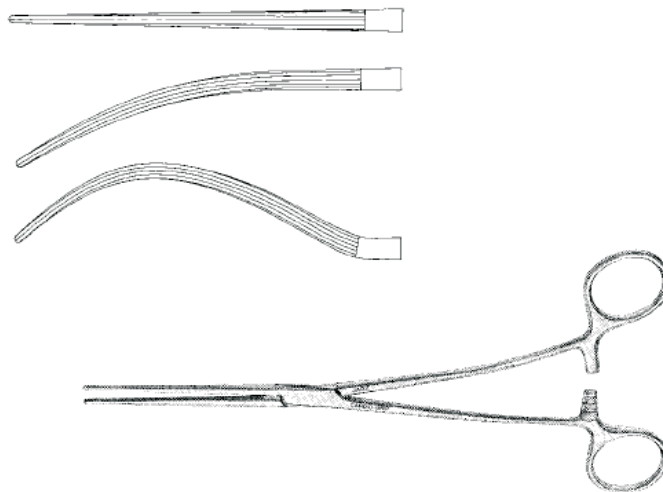

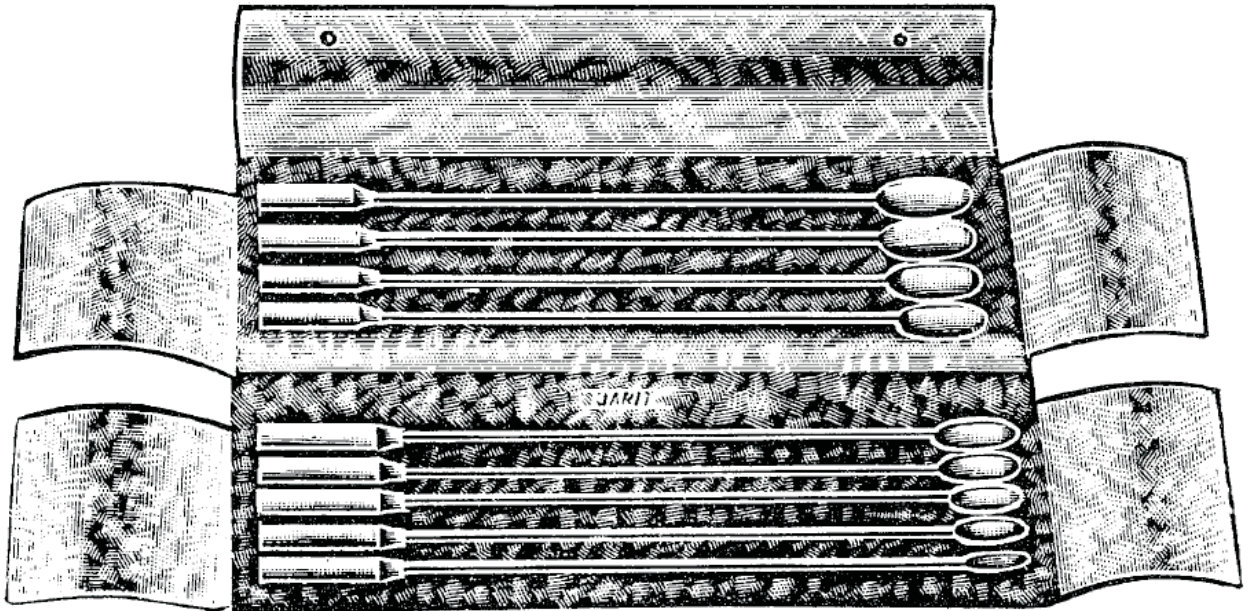

**140-100 BAKES** Common Duct Dilators, 8 1/2" (21.6cm), set of 9

**140-101 BAKES** Dilator 3mm, 8 1/2" (21.6cm)

**140-102 BAKES** Dilator 4mm, 8 1/2" (21.6cm)

**140-103 BAKES** Dilator 5mm, 8 1/2" (21.6cm)

**140-104 BAKES** Dilator 6mm, 8 1/2" (21.6cm)

**140-105 BAKES** Dilator 7mm, 8 1/2" (21.6cm)

**140-106 BAKES** Dilator 8mm, 8 1/2" (21.6cm)

**140-107 BAKES** Dilator 9mm, 8 1/2" (21.6cm)

**140-108 BAKES** Dilator 10mm, 8 1/2" (21.6cm)

**140-109 BAKES** Dilator 11mm, 8 1/2" (21.6cm)

**FERGUSON** Gall Stone Scoops, 8 1/2" (21.6cm), double-ended

**140-154** Small

**140-155** Medium

**140-156** Large

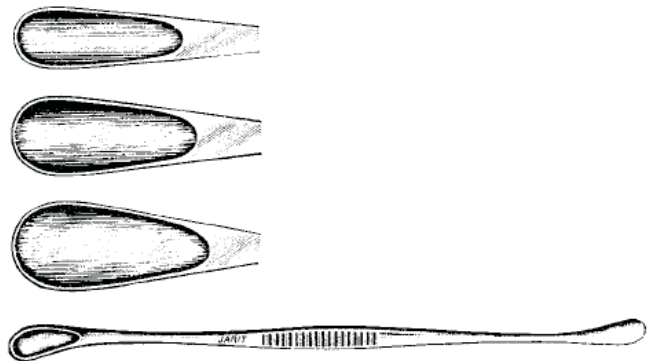

**140-175 DESJARDIN** Gall Stone Forceps,  
9¼" (23.5cm)

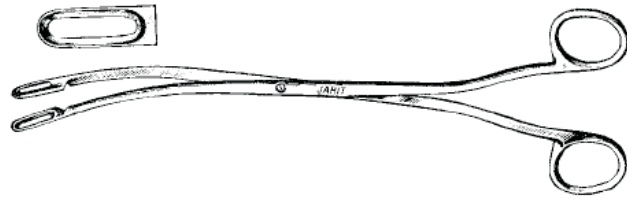

**BLAKE** Gall Stone Forceps,  
8¼" (21cm)

- 140-190** Straight
- 140-192** Curved

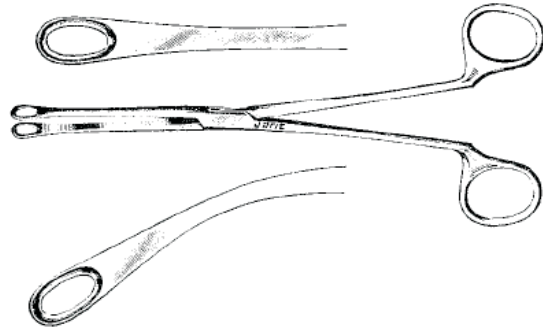

**LAHEY** Gall Duct Forceps

- 140-205** 7½" (19.1cm)
- 140-206** 7¾" (19.7cm), delicate

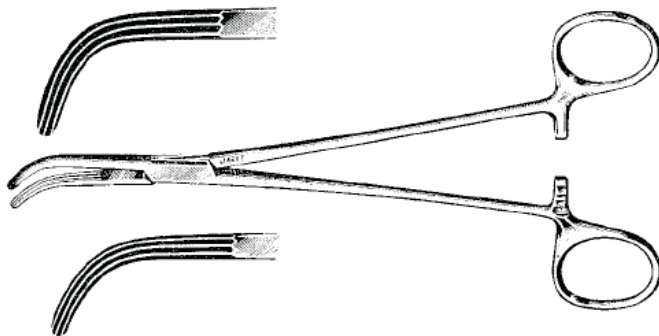

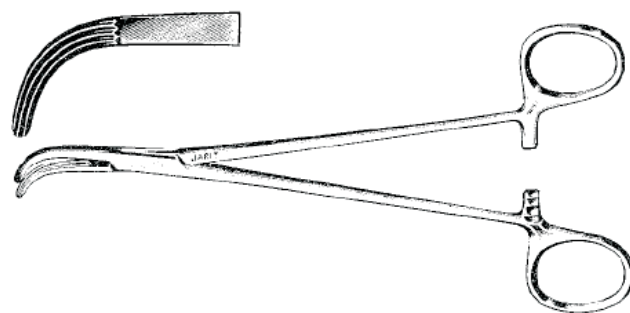

**140-210** LOWER Gall Duct Forceps,  
7½" (19.1cm)

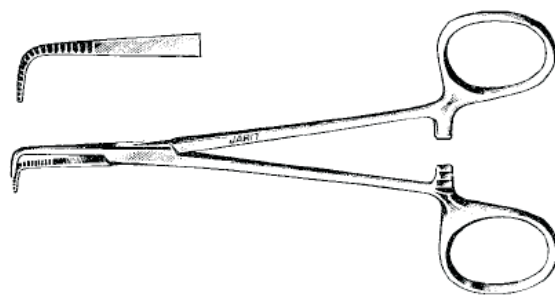

**140-218** PETIT-POINT MIXTER Forceps,  
5¼" (13.3cm)

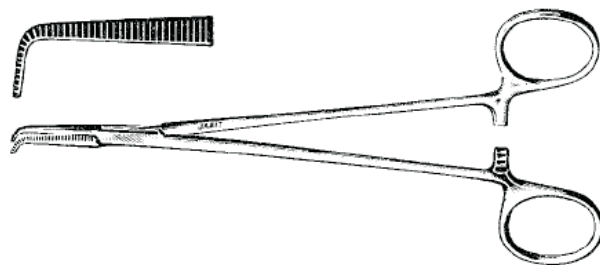

**140-223** PETIT-POINT MIXTER Forceps,  
7¼" (18.4cm)

**MIXTER Forceps**

- 140-224 6½" (16.5cm)
- 140-225 7" (17.8cm)

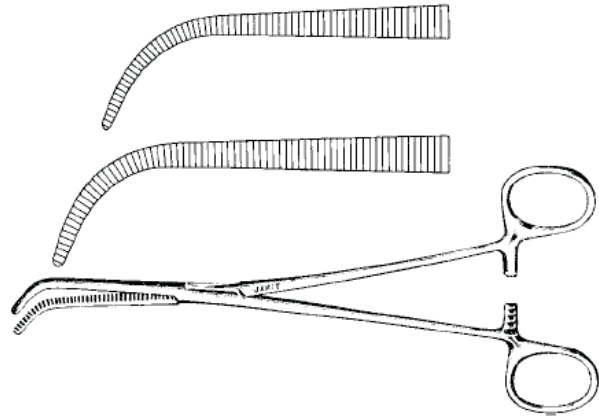

**MIXTER Forceps**

- 140-226 8¼" (21cm)
- 140-230 9" (22.9cm)

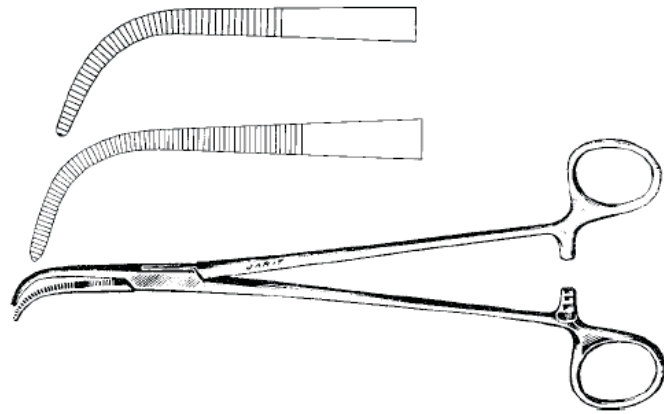

- 140-231 **MEEKER** Clamp,  
7" (17.8cm), right angle

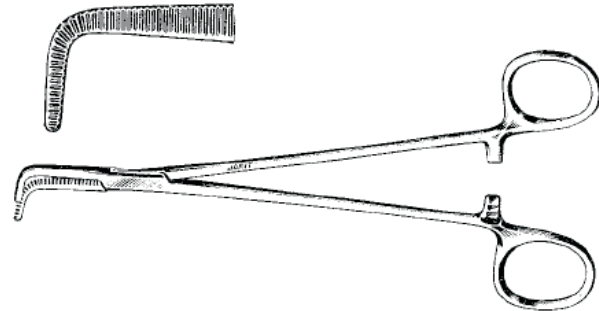

**DIETRICH Clamps,**  
right angle

- 140-232 4¾" (12.1cm)
- 140-233 5¾" (14.3cm)
- 140-234 7" (17.8cm)

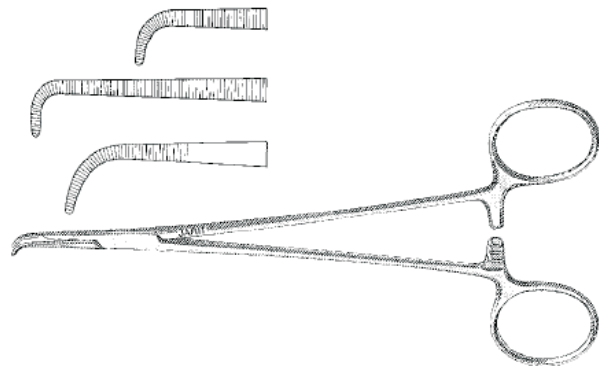

**JARIL** GALLBLADDER INSTRUMENTS

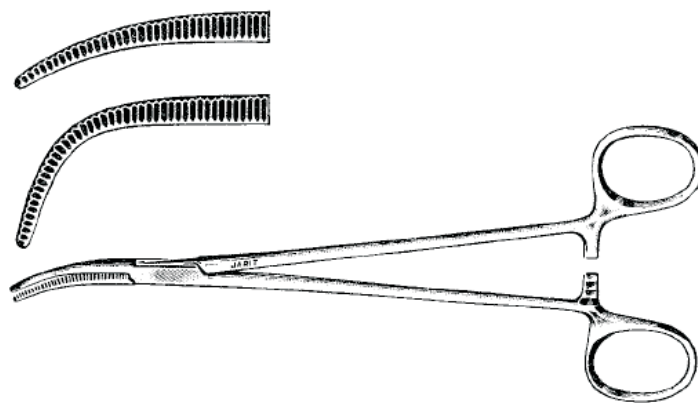

**VARCO** Gallbladder Forceps

- 140-240 7½" (19.1cm), slight curve
- 140-245 7½" (19.1cm), full curve

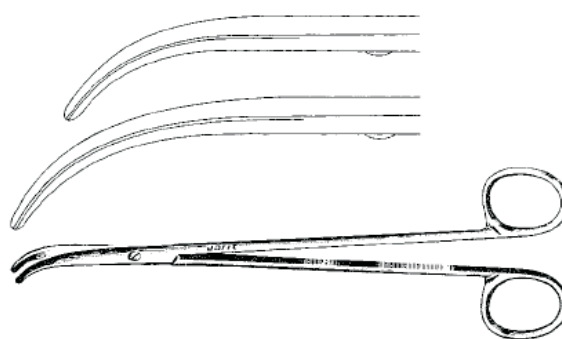

**THOREK** Scissors

- 140-320 7½" (19.1cm), full curve
- 140-322 9" (22.9cm), full curve

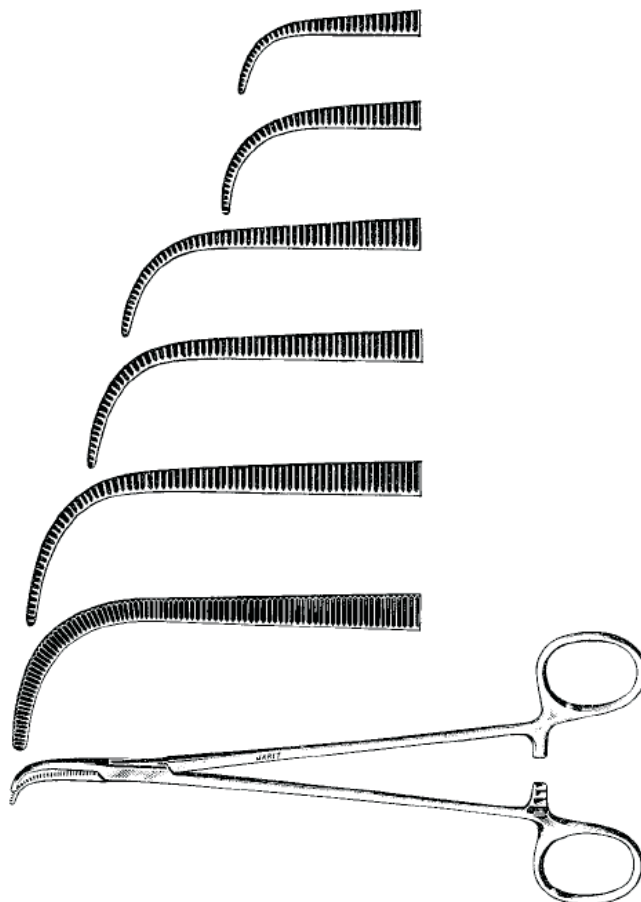

**GEMINI** Clamps

- 140-329 5½" (14cm)
- 140-330 7" (17.8cm)
- 140-331 8" (20.3cm)
- 140-332 9" (22.9cm)
- 140-333 11" (27.9cm)
- 140-335 14" (35.6cm)



**JART** GOITRE INSTRUMENTS AND VEIN STRIPPER

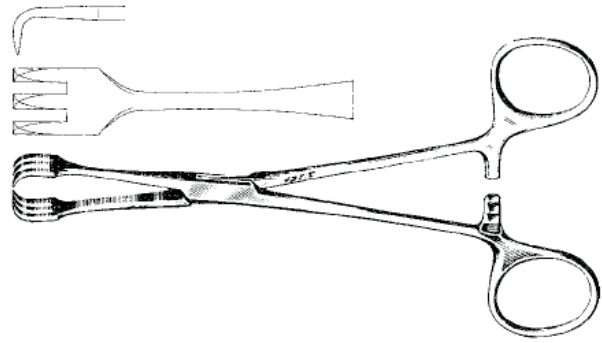

**LAHEY** Traction Forceps,  
150-160 6" (15.2cm)  
150-165 8" (20.3cm)

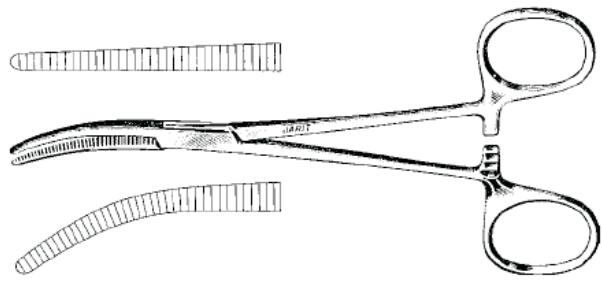

**LAHEY** Hemostats,  
5½" (14cm)  
150-175 Straight  
150-180 Curved

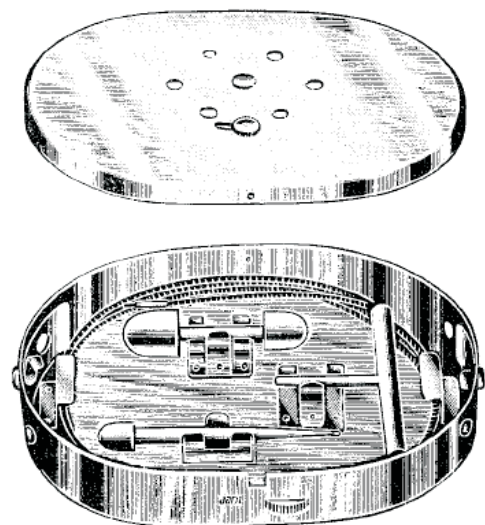

160-120 **NABATOFF** Vein Stripper,  
complete set in stainless steel sterilizing case

**170-100** POOLE Suction Tube,  
9 $\frac{3}{4}$ " (24.8cm), angular, 26 French



**170-101** POOLE Suction Tube,  
7 $\frac{3}{4}$ " (19.7cm), pediatric,  
angular, 17 French, chrome plated



POOLE Suction Tubes,  
straight, 32 French

**170-102** 9 $\frac{3}{4}$ " (23.8cm)

**170-103** 12" (30.5cm)

**170-104** 15" (38cm)



**170-105** **JARIT-POOLE** Abdominal Suction Tube,  
10 $\frac{1}{4}$ " (26cm), with control valve, chrome plated



**170-115** **ANDREWS-PYNCHON** Suction Tube,  
9 $\frac{3}{8}$ " (23.8cm)

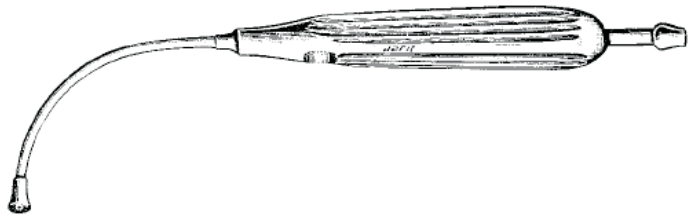

**170-118** **YANKAUER** Suction Tube,  
8 $\frac{1}{4}$ " (21cm), pediatric

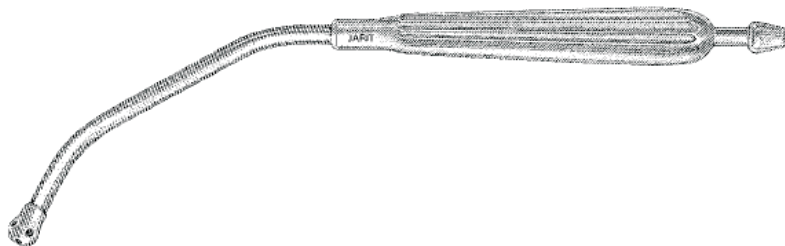

**JARIT** SUCTION TUBES



**YANKAUER** Suction Tube

Satin	Matte	
<b>170-120</b>	<b>169-120</b>	11½" (29.2cm)
<b>170-117</b>		15" (38cm)

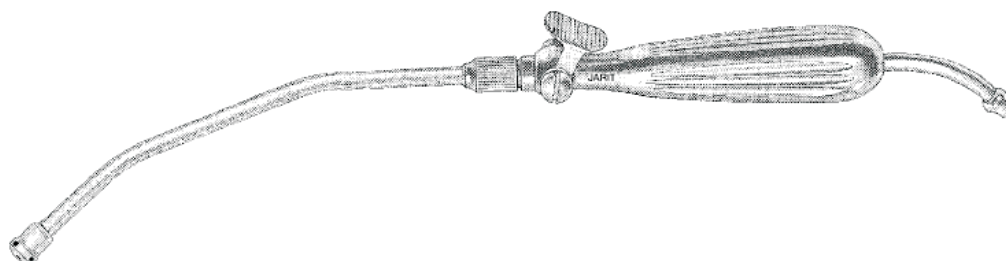

**170-122 JARIT-YANKAUER** Suction Tube,  
12½" (31.8cm), with control valve, chrome plated

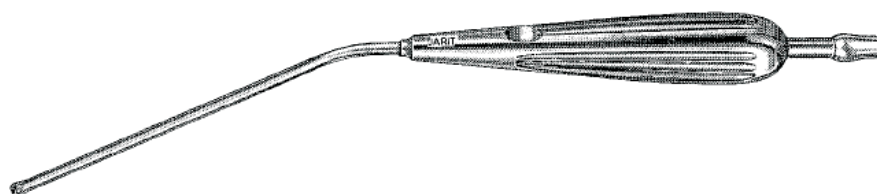

**170-124 ANTHONY** Suction Tube,  
10" (25.4cm), 2mm opening

**OCHSNER** Gallbladder Trocars,  
6" (15.2cm)

<b>170-150</b>	10 French	<b>170-155</b>	20 French
<b>170-151</b>	12 French	<b>170-156</b>	22 French
<b>170-152</b>	14 French	<b>170-157</b>	24 French
<b>170-153</b>	16 French	<b>170-158</b>	26 French
<b>170-154</b>	18 French	<b>170-160</b>	28 French

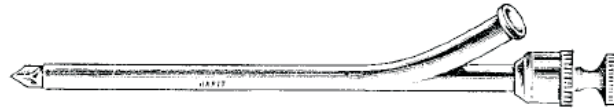

**170-165** **NESTED** Trocars,  
flat handle, set of 4 (6, 9, 13, 17 French)

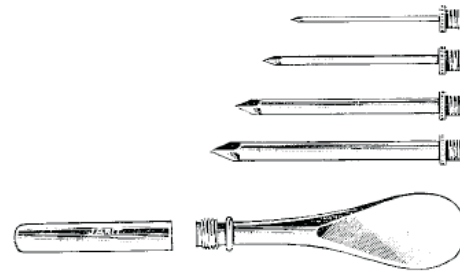

**170-170** **DUKE** Trocar and Drainage Cannula,  
15 French trocar, 17 French cannula

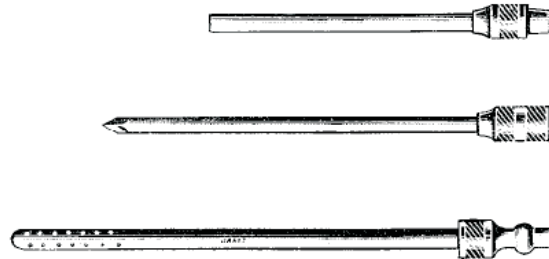

**170-175** **CATHETER** Guide,  
4 French



**NELSON (PATTERSON)** Empyema Trocars,  
8 1/4" (21cm)

<b>170-192</b>	Size 1: 6mm
<b>170-193</b>	Size 2: 8mm
<b>170-194</b>	Size 3: 9.5mm
<b>170-195</b>	Size 4: 11mm

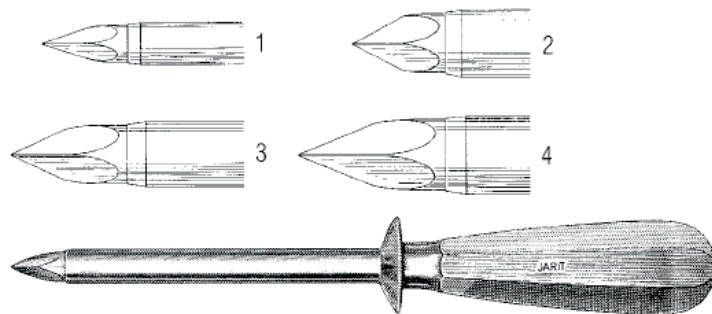

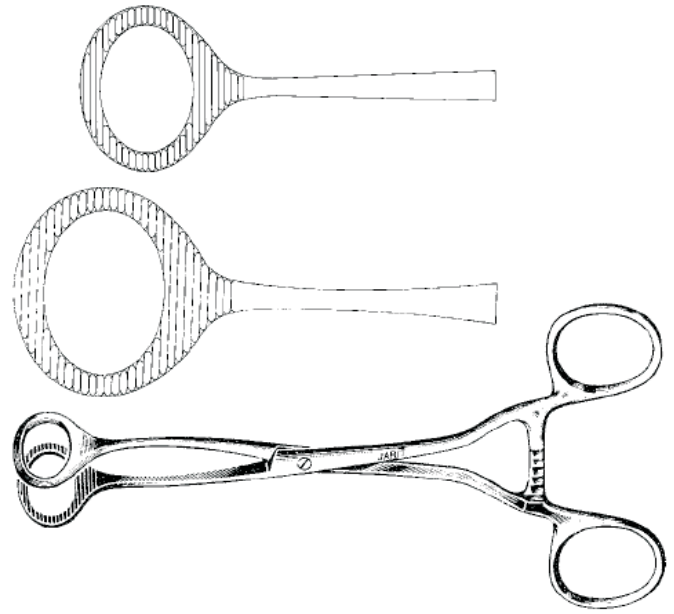

**COLLINS** Tongue Seizing Forceps

- 175-100 6 $\frac{3}{4}$ " (17.2cm), small
- 175-105 7 $\frac{1}{4}$ " (18.5cm), large

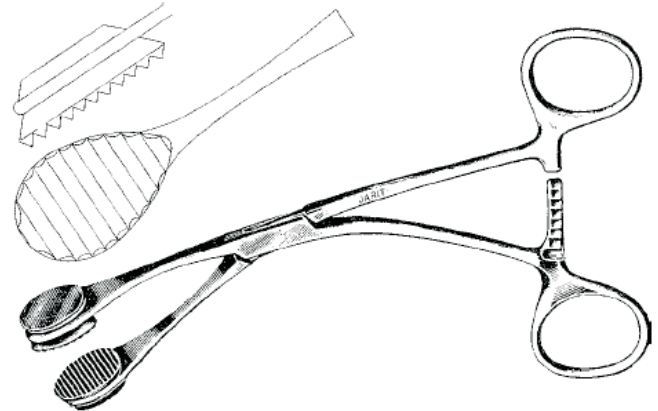

**YOUNG** Tongue Seizing Forceps

- 175-110 6 $\frac{1}{4}$ " (15.9cm)
- 175-111 Rubber (latex free) jaws only, set of 2

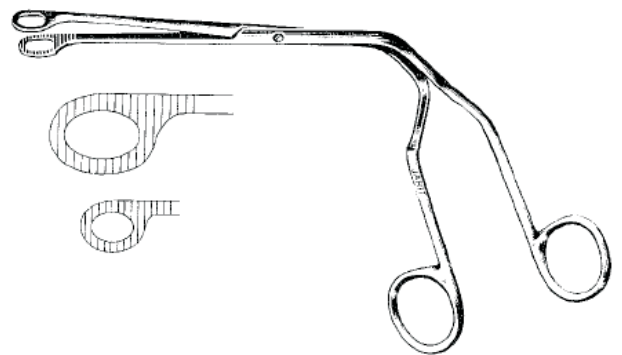

**MAGILL** Catheter Forceps

- 175-120 9 $\frac{3}{4}$ " (24.8cm), adult size
- 175-121 7 $\frac{1}{4}$ " (18.4cm), pediatric size

**TAYLOR** Percussion Hammers,  
solid handle

- 180-100 6½" (16.5cm), small
- 180-105 7½" (19cm), large



- 180-110 **RABINER** Neurological Hammer,  
10" (25.4cm)

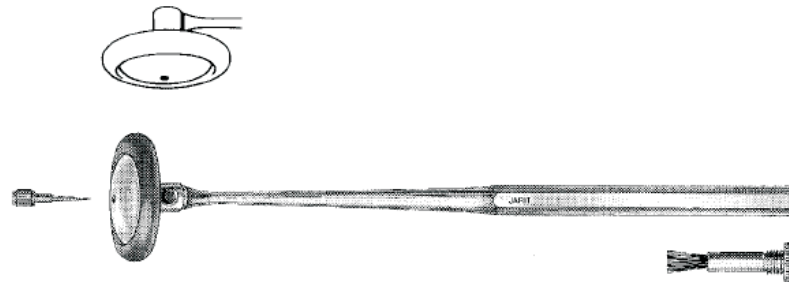

- 180-115 **BUCK** Neurological Hammer,  
7½" (19.1cm)

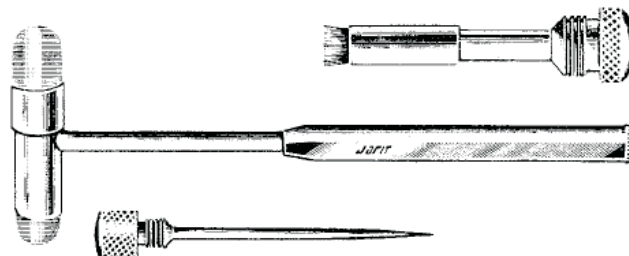

- 180-130 **WARTENBERG** Pin Wheel,  
7¼" (18.4cm)



**180-160 BINOCULAR MAGNIFYING LOUPE,**  
mounted on frame, coated optics,  
1.8x magnification, 12" (30cm) focal length,  
4" (10cm) depth of field. With storage case.

**180-165 BINOCULAR MAGNIFYING LOUPE** Only

**180-166** Accessory lenses only, not included in set,  
increase magnification to 2.5x

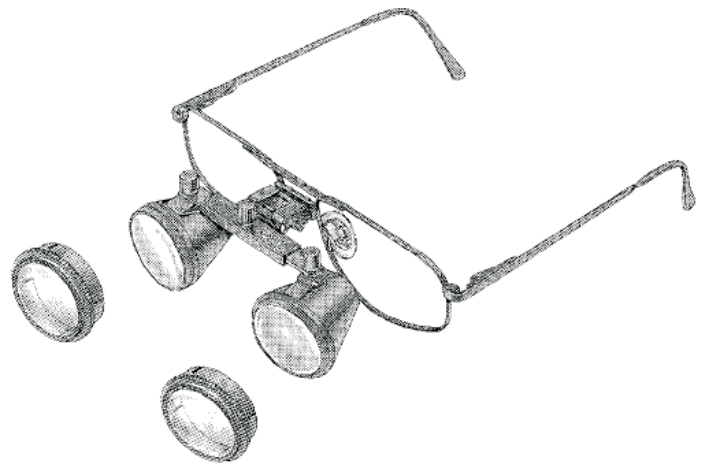

**UNIVERSITY OF ILLINOIS Bone Marrow Biopsy Needles**

**180-175** 3/4" (8.3cm), 1" (2.5cm) cannula, 18 gauge

**180-176** 3/4" (8.3cm), 1" (2.5cm) cannula, 15 gauge



**FRANKLIN-SILVERMAN Tissue Biopsy Needles**

**180-178** 4 7/8" (12.4cm), 3 3/8" (8.6cm) cannula, 14 gauge

**180-179** 6" (15.2cm), 4 1/2" (11.4cm) cannula, 16 gauge

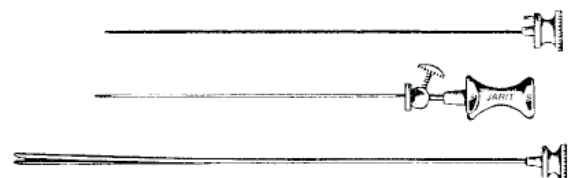





# LAPAROTOMY RINGS, PROBES AND GROOVED DIRECTORS

### LAPAROTOMY Rings

- 180-180 1" (2.5cm)
- 180-182 1½" (3.8cm)
- 180-184 2" (5.1cm)
- 180-188 3" (7.6cm)

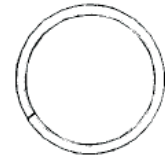

### PROBES with eye, stainless

- 180-200 4½" (11.4cm)
- 180-201 5" (12.7cm)
- 180-202 5½" (14cm)
- 180-203 6" (15.2cm)
- 180-204 7" (17.8cm)
- 180-205 8" (20.3cm)
- 180-207 10" (25.4cm)



### PROBES, double ended, stainless

- 180-222 4½" (11.4cm)
- 180-223 5" (12.7cm)
- 180-224 5½" (14cm)
- 180-225 6" (15.2cm)
- 180-226 7" (17.8cm)
- 180-227 8" (20.3cm)
- 180-228 10" (25.4cm)



### PROBES with eye, silver

- 180-231 4½" (11.4cm)
- 180-232 5" (12.7cm)
- 180-233 5½" (14cm)
- 180-234 6" (15.2cm)
- 180-235 7" (17.8cm)
- 180-236 8" (20.3cm)
- 180-238 10" (25.4cm)



### GROOVED DIRECTORS-Tongue Tie, plain point, stainless

- 180-250 4½" (11.4cm)
- 180-251 5" (12.7cm)
- 180-252 5½" (14cm)
- 180-253 6" (15.2cm)
- 180-255 8" (20.3cm)



### GROOVED DIRECTORS-Tongue Tie, probe point, stainless

- 180-260 4½" (11.4cm)
- 180-261 5" (12.7cm)
- 180-262 5½" (14cm)
- 180-263 6" (15.2cm)
- 180-265 8" (20.3cm)



185-100 **SAALFELD** Comedone Extractor,  
4½" (11.4cm)



185-105 **SAALFELD** Comedone Extractor,  
5¾" (14.6cm)



185-110 **SCHAMBERG** Comedone Extractor,  
3¾" (9.5cm)



185-115 **UNNA** Comedone Extractor,  
5¾" (14.6cm)



185-120 **JARIT** Comedone Extractor,  
6" (15.2cm)



- 185-135 **FINGER RING** Cutter
- 185-136 Replacement blade only

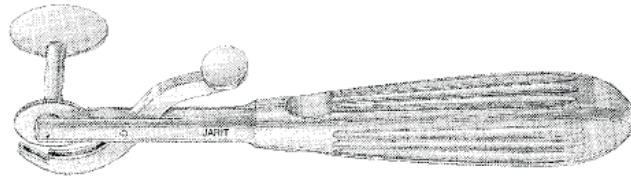

- 185-150 **KEYES** Dermal Punch Set
- Replacement heads only

- 185-152 2mm
- 185-153 3mm
- 185-154 4mm
- 185-155 5mm
- 185-156 6mm
- 185-157 7mm

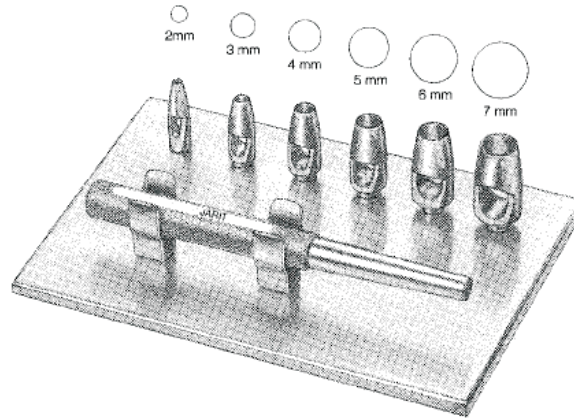

**KEYES** Dermal Punches,  
4" (10.1cm)

- 185-170 2mm
- 185-171 3mm
- 185-172 4mm
- 185-176 5mm
- 185-173 6mm
- 185-174 8mm
- 185-175 10mm



**FOX** Dermal Curettes,  
5½" (14cm)

- 185-179 2mm
- 185-180 3mm
- 185-181 4mm
- 185-182 5mm
- 185-183 6mm



**PIFFARD** Dermal Curettes,  
6½" (15.9cm)

- 185-185 4mm
- 185-186 5mm
- 185-187 6mm



**NAIL Nippers,**  
concave, barrel spring

- 185-190 4½" (11.4cm), chrome
- 185-191 4½" (11.4cm), stainless steel
- 185-192 5½" (13cm), chrome
- 185-193 5½" (13cm), stainless steel

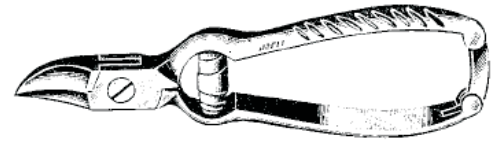

**NAIL Nippers,**  
5" (12.7cm), straight

- 185-195 chrome
- 185-196 stainless steel

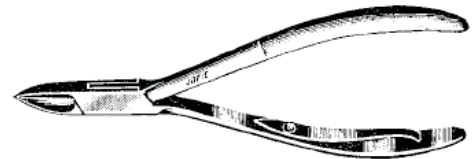

**NAIL Nippers,**  
5½" (14cm), concave

- 185-200 chrome
- 185-201 stainless steel

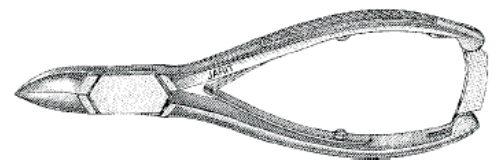

**NAIL Nippers,**  
5½" (14cm), angled concave

- 185-205 chrome
- 185-206 stainless steel



**CUTICLE Nippers**,  
3¼" (9.5cm), convex

185-230 chrome

185-231 stainless steel

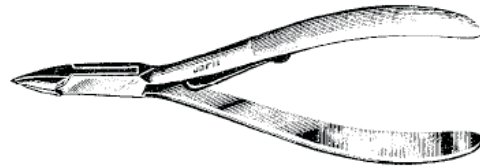

185-250 **CUTICLE Scissors**,  
3½" (8.9cm), curved

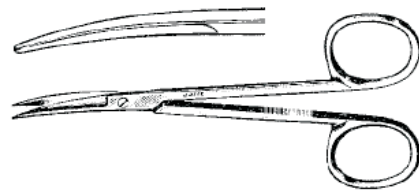

185-260 **NAIL Scissors**,  
3½" (8.9cm), heavy



**JARIT FINGER RETRACTORS**

**FLEXIBLE** Shaft Retractors,  
6" (15.2cm)

- 190-100** 1 prong, sharp
- 190-101** 2 prongs, sharp, 5mm wide
- 190-102** 3 prongs, sharp, 8mm wide
- 190-103** 1 prong, blunt
- 190-104** 2 prongs, blunt, 5mm wide
- 190-105** 3 prongs, blunt, 8mm wide

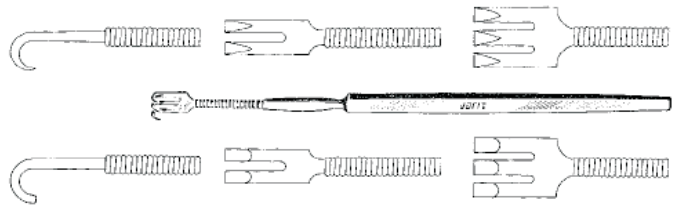

**SENN** Retractors,  
6¼" (15.9cm), double-ended, 8mm wide,  
solid blade ¾" x ¼" (19mm x 6.3mm)

- |                |                |                |
|----------------|----------------|----------------|
| Satin          | Matte          |                |
| <b>190-110</b> | <b>189-110</b> | 3 sharp prongs |
| <b>190-112</b> | <b>189-112</b> | 3 blunt prongs |

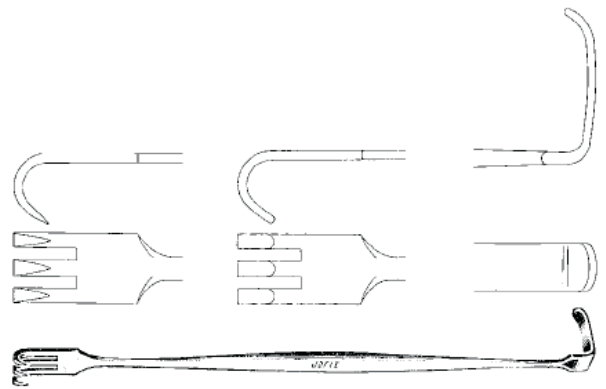

**MATHIEU** Retractors,  
6¼" (15.9cm), double-ended, 8mm wide,  
solid blade ¾" x ¼" (19mm x 6.3mm)

- 190-115** 3 sharp prongs
- 190-116** 3 blunt prongs

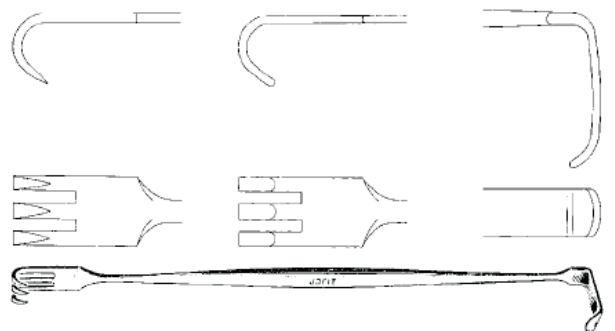

- 190-118** **ROLLET** Retractor,  
5" (12.7cm), 4 sharp prongs, 6mm wide



- 190-120** **KNAPP** Retractor,  
5" (12.7cm), 4 blunt prongs, 6mm wide



**JARIT** FINGER RETRACTORS

- 190-129 MEYERDING Skin Hook and Retractor,**  
6¼" (15.9cm), solid blade ⅝" x ⅜" wide (16mm x 5mm)

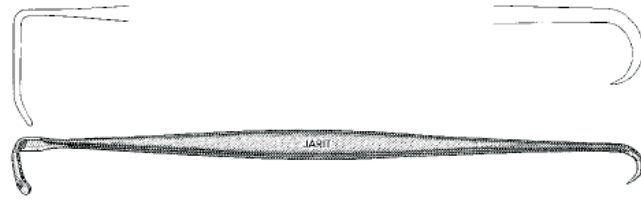

**MEYERDING Finger Retractors,**  
7" (17.8cm)

- 190-130** Style 1, 1⅜" x ⅝" wide (21mm x 7.1mm)  
**190-131** Style 2, ⅝" x ⅜" wide (16mm x 5mm)  
**190-132** Style 3, ¼" x ⅝" wide (6.3mm x 4mm)  
**190-133** Style 4, ⅜" x ⅜" wide (10mm x 3.2mm)  
**190-134** Style 5, ⅝" x ⅝" wide (8mm x 4mm)  
**190-135** Style 6, ¼" x ⅜" wide (6.3mm x 8mm)

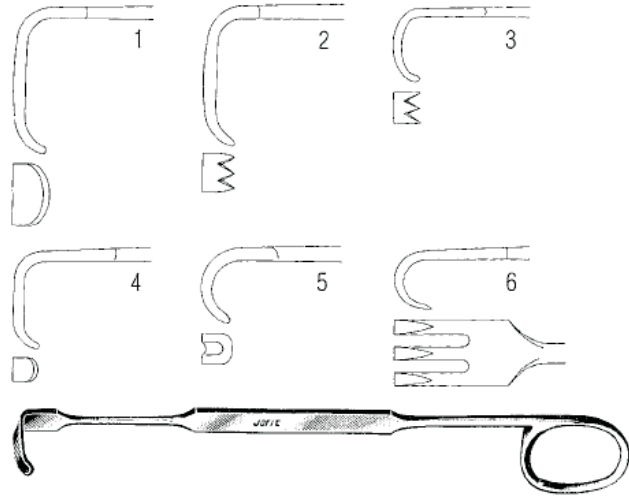

**FINGER Rake Retractors,**  
6½" (16.5cm)

- 190-150** 1 prong, sharp  
**190-151** 2 prongs, sharp, 5mm wide  
**190-152** 3 prongs, sharp, 8mm wide  
**190-153** 4 prongs, sharp, 12mm wide  
**190-154** 1 prong, blunt  
**190-155** 2 prongs, blunt, 5mm wide  
**190-156** 3 prongs, blunt, 8mm wide  
**190-157** 4 prongs, blunt, 12mm wide

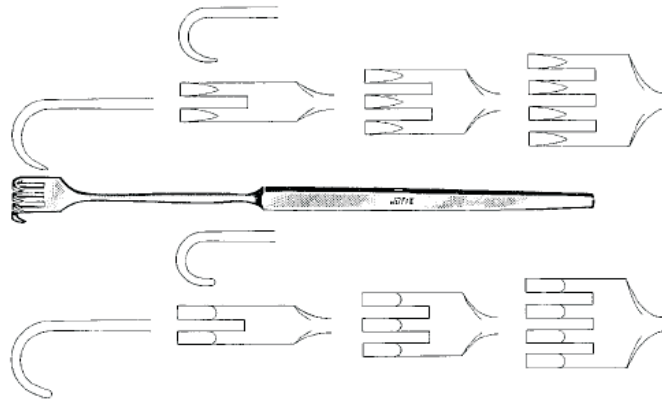

**VOLKMAN Retractors,**  
4⅝" (11.8cm)

- 190-170** 2 prongs, sharp, 8mm wide  
**190-171** 3 prongs, sharp, 10mm wide  
**190-172** 4 prongs, sharp, 13mm wide  
**190-173** 6 prongs, sharp, 19mm wide  
**190-175** 2 prongs, blunt, 8mm wide  
**190-176** 3 prongs, blunt, 10mm wide  
**190-177** 4 prongs, blunt, 13mm wide  
**190-178** 6 prongs, blunt, 19mm wide

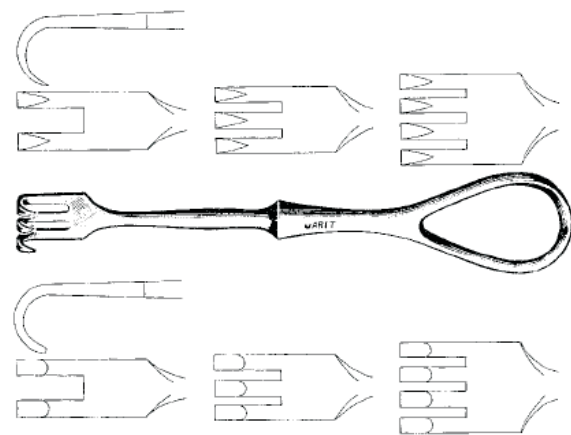

**200-100 MAYO-COLLINS Retractor,**  
6" (15.2cm), double-ended, set of 2,  
blades  $\frac{3}{4}$ " x  $\frac{7}{8}$ " deep and  $\frac{3}{4}$ " x  $1\frac{1}{8}$ " deep  
(1.9cm x 2.2cm) and (1.9cm x 2.9cm)

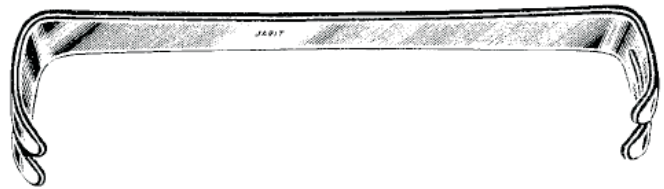

**U.S. ARMY Retractor,**  
8 $\frac{1}{2}$ " (21cm), double-ended, blades  $\frac{5}{8}$ " (1.5cm) wide, set of 2

Satin Matte

**200-105 199-105** Small blade:  $\frac{7}{8}$ " and  $1\frac{1}{2}$ " deep (2.2cm and 3.8cm)  
Large blade: 1" and  $1\frac{3}{8}$ " deep (2.5cm and 4.1cm)



**ROUX Retractors,**  
6 $\frac{1}{2}$ " (16.5cm), double-ended

**200-106** Set of 3  
**200-107** Small:  $\frac{7}{8}$ " and  $1\frac{1}{8}$ " wide (21mm and 29mm) blades  
**200-108** Medium: 1" and  $1\frac{1}{2}$ " wide (26mm and 37mm) blades  
**200-109** Large:  $1\frac{1}{4}$ " and  $1\frac{3}{4}$ " wide (31mm and 45mm) blades

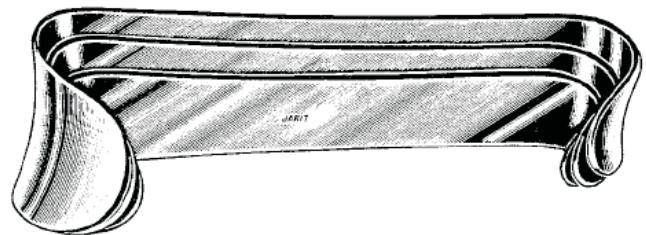



**200-110 FARABEUF Retractor,**  
4½" (11.4cm), double-ended, set of 2,  
blades ⅞" x 1" deep (1.1cm x 2.5cm) and  
½" x 1" deep (1.3cm x 2.5cm)



**200-115 FARABEUF Retractor,**  
6" (15.2cm), double-ended, set of 2,  
blades ⅞" x 1" deep (1.6cm x 2.5cm) and  
⅝" x 1½" deep (1.6cm x 3.2cm)



**200-119 SISTRUNK Retractor,**  
6" (15.2cm), double-ended,  
blade ⅞" x 1" deep (1cm x 2.5cm)



**200-120 PARKER Retractor,**  
5" (12.7cm), double-ended, set of 2,  
blades ⅞" x ⅜" deep (1.6cm x 1.9cm)

**200-122 PARKER Retractor,**  
7" (17.8cm), double-ended, set of 2,  
blades 1" x 1" deep (2.5cm x 2.5cm)



**200-125 PARKER-MOTT Retractor,**  
5¾" (14.6cm), double-ended, set of 2,  
blades 1" x 2½" deep (2.5cm x 6.4cm)

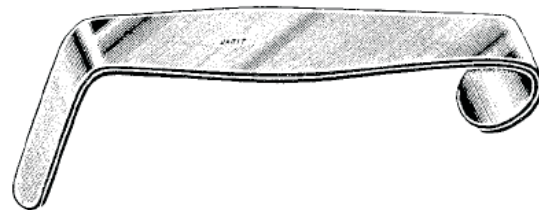

**LANGENBECK** Retractors,  
8 $\frac{1}{2}$ " (21.6cm)

- 200-126 Small blade:  $\frac{3}{8}$ " x 1 $\frac{1}{8}$ " deep (1cm x 4.1cm)
- 200-127 Medium blade:  $\frac{1}{2}$ " x 1 $\frac{1}{8}$ " deep (1.3cm x 4.1cm)
- 200-128 Large blade:  $\frac{5}{8}$ " x 1 $\frac{1}{8}$ " deep (1.6cm x 4.1cm)



- 200-130 **GOELET** Retractor,  
7 $\frac{1}{2}$ " (19cm), double-ended,  
blades 1 $\frac{1}{4}$ " and 1 $\frac{3}{8}$ " wide (3.2cm and 4.1cm)



- 200-131 **McBURNIEY** Thyroid Retractor,  
7 $\frac{1}{2}$ " (19cm), blade  $\frac{5}{8}$ " x  $\frac{3}{8}$ " wide (1.6cm x 1cm)



- 200-132 **GREEN** Thyroid Retractor,  
8 $\frac{1}{2}$ " (21.6cm), blade  $\frac{1}{8}$ " x  $\frac{5}{8}$ " wide (2.2cm x 1.6cm)



- 200-133 **LITTLE** Retractor,  
7 $\frac{1}{2}$ " (19cm), blade  $\frac{3}{8}$ " x  $\frac{7}{16}$ " wide (1.6cm x 1.1cm)



**200-134 LAHEY** Thyroid Retractor,  
8" (20.3cm), blade 1" x 1/4" wide (25mm x 7mm)

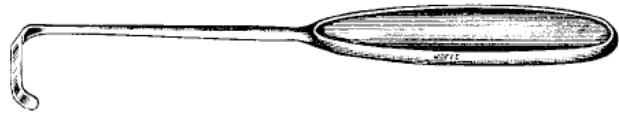

**CUSHING** Vein Retractor,  
blade 3/8" x 7/8" wide (9.5mm x 11mm)

Satin Matte

<b>200-135</b>	<b>199-135</b>	9" (22.8cm)
<b>200-136</b>		11" (27.9cm)
<b>200-137</b>		14" (35.6cm)



**200-138 CRILE** Retractor,  
4 1/4" (11cm), double-ended,  
blades 1/2" x 1/8" wide (13mm x 3.2mm)  
and 7/8" x 1/4" wide (22mm x 6.4mm)



**SAUERBRUCH Retractors,**  
9" (22.9cm)

- 200-140** Blade 1 $\frac{3}{8}$ " x  $\frac{5}{8}$ " wide (4.5 x 1.6cm)
- 200-142** Blade 2 $\frac{1}{2}$ " x  $\frac{7}{8}$ " wide (6.4 x 2.2cm)
- 200-143** Blade 2 $\frac{7}{8}$ " x  $\frac{3}{4}$ " wide (7.3 x 1.9cm)

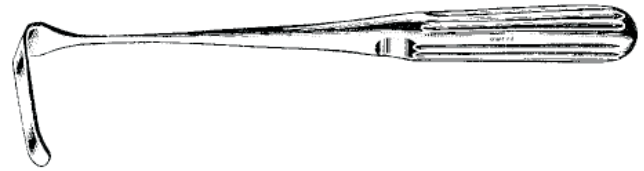

**DOYEN Retractors,**  
8 $\frac{1}{2}$ " (21.6cm)

- 200-145** Blade 1 $\frac{3}{8}$ " x 2  $\frac{1}{2}$ " deep (4.5 x 6.4cm)
- 200-147** Blade 2 $\frac{1}{8}$ " x 3" deep (5.4 x 7.6cm)
- 200-149** Blade 2 $\frac{1}{4}$ " x 3 $\frac{1}{2}$ " deep (5.7 x 8.9cm)

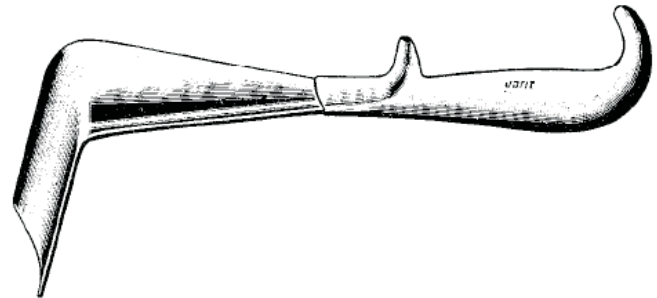

**RICHARDSON-EASTMAN Retractors,**  
double-ended

- 200-150** Set of 2
- 200-151** Small size: 10" (25.4cm),  
blades  $\frac{3}{4}$ " wide x 1 $\frac{1}{8}$ " deep,  
and 1 $\frac{1}{8}$ " wide x 1 $\frac{1}{2}$ " deep.  
(1.9 x 2.9cm) and (2.9 x 3.8cm)
- 200-152** Large size: 10 $\frac{5}{8}$ " (27cm),  
blades 1 $\frac{1}{2}$ " wide x 1 $\frac{3}{4}$ " deep,  
and 1 $\frac{1}{8}$ " wide x 2 $\frac{1}{2}$ " deep.  
(3.8 x 4.5cm) and (4.1 x 6.4cm)

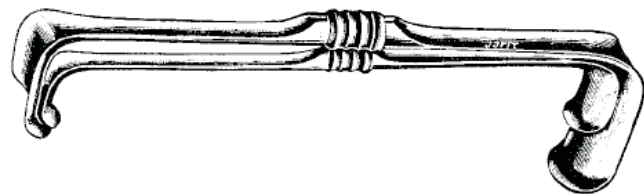

**RICHARDSON Retractors,**  
Lamb handle, 10½" (26.7cm)

- 200-155 Blade ¾" wide x 1" deep (1.9 x 2.5cm)
- 200-156 Blade 1" wide x 1¼" deep (2.5 x 3.2cm)
- 200-157 Blade 1½" wide x 1½" deep (3.8 x 3.8cm)



**RICHARDSON Retractors,**  
hollow grip handle, 9½" (24.1cm)

- 201-155 Blade ¾" wide x 1" deep (1.9 x 2.5cm)
- 201-156 Blade 1" wide x 1¼" deep (2.5 x 3.2cm)
- 201-157 Blade 1½" wide x 1½" deep (3.8 x 3.8cm)

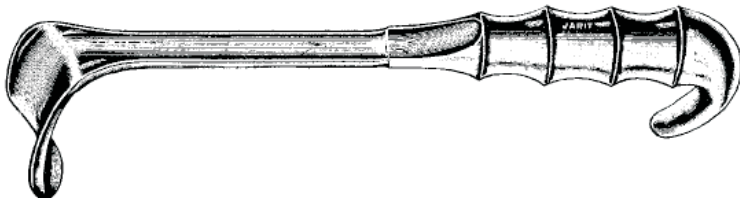

**RICHARDSON Retractors,**  
loop handle, 9½" (24.1cm)

- 202-155 Blade ¾" wide x 1" deep (1.9 x 2.5cm)
- 202-156 Blade 1" wide x 1¼" deep (2.5 x 3.2cm)
- 202-157 Blade 1½" wide x 1½" deep (3.8 x 3.8cm)



**Jarit** HAND RETRACTORS

**200-160 RICHARDSON** Appendectomy Retractor,  
Lamb handle, 10 $\frac{1}{4}$ " (26cm),  
blade  $\frac{3}{4}$ " wide x 2" deep (1.9 x 5.1cm)

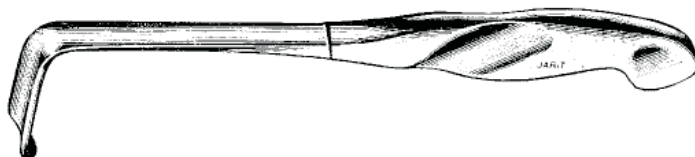

**201-160 RICHARDSON** Appendectomy Retractor,  
hollow grip handle, 9 $\frac{1}{4}$ " (23.5cm),  
blade  $\frac{3}{4}$ " wide x 2" deep (1.9 x 5.1cm)

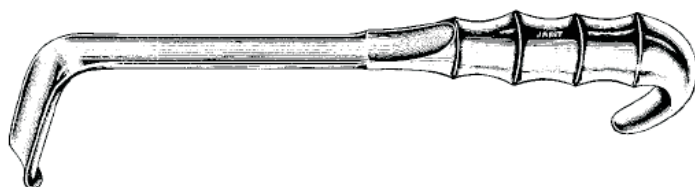

**202-160 RICHARDSON** Appendectomy Retractor,  
loop handle, 9 $\frac{1}{4}$ " (23.5cm),  
blade  $\frac{3}{4}$ " wide x 2" deep (1.9 x 5.1cm)

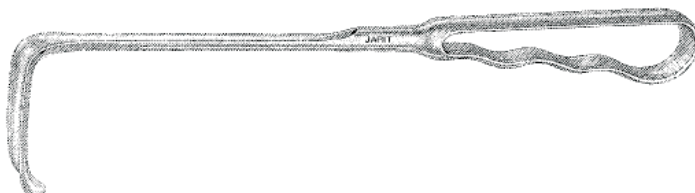

**475-429 MURPHY** Gall Bladder Retractor,  
11" (28cm),  
blade 2" wide (5cm)

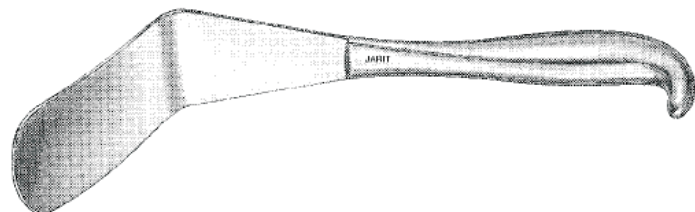

**200-261 SEMB** Retractor,  
9 $\frac{7}{8}$ " (25cm),  
small blade  $\frac{5}{8}$ " wide x 1 $\frac{1}{4}$ " deep (1.5 x 3.2cm)

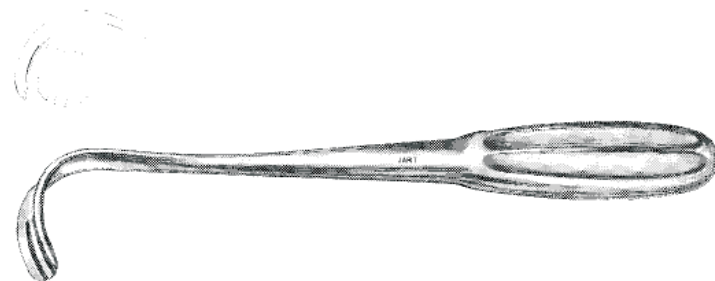

**KELLY Retractors,**  
Lamb handle, 11" (28cm)

- 200-165** Blade 1½" x 2" deep (3.8 x 5.1cm)
- 200-166** Blade 2" x 2½" deep (5.1 x 6.4cm)
- 200-167** Blade 2½" x 3" deep (6.4 x 7.6cm)
- 200-168** Blade 3" x 3½" deep (7.6 x 8.9cm)

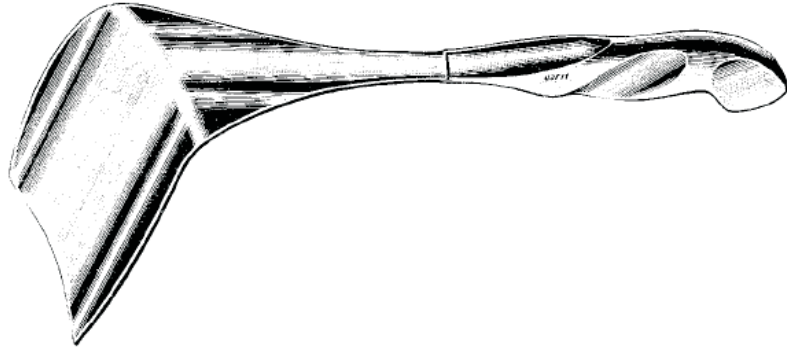

**KELLY Retractors,**  
hollow grip handle, 10" (25.4cm)

- 201-165** Blade 1½" x 2" deep (3.8 x 5.1cm)
- 201-166** Blade 2" x 2½" deep (5.1 x 6.4cm)
- 201-167** Blade 2½" x 3" deep (6.4 x 7.6cm)
- 201-168** Blade 3" x 3½" deep (7.6 x 8.9cm)

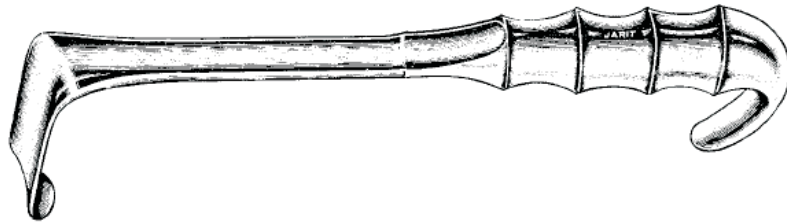

**KELLY Retractors,**  
loop handle, 9¾" (24.8cm)

- 202-165** Blade 1½" x 2" deep (3.8 x 5.1cm)
- 202-166** Blade 2" x 2½" deep (5.1 x 6.4cm)
- 202-167** Blade 2½" x 3" deep (6.4 x 7.6cm)
- 202-168** Blade 3" x 3½" deep (7.6 x 8.9cm)

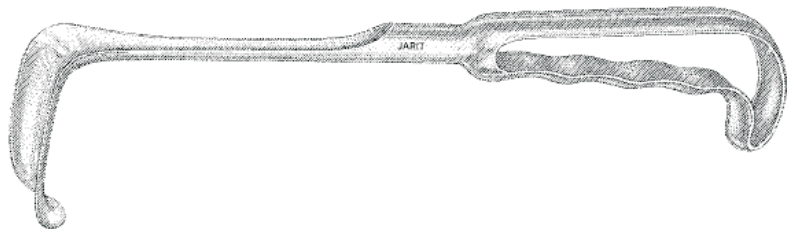

**200-170** **MAYO** Abdominal Retractor,  
Lamb handle, 11" (27.9cm),  
blade 2¾" wide (7cm)

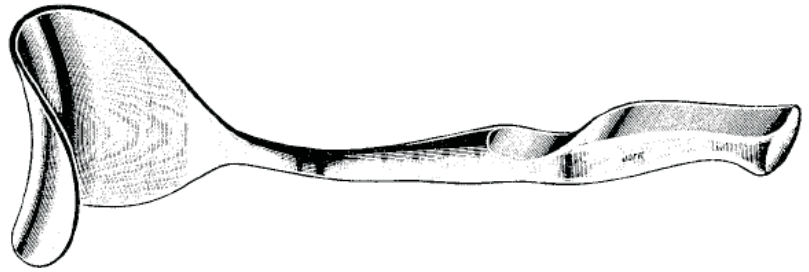

**HIBBS** Retractors,  
9½" (24.2cm)

**200-172** Blade 1" x 3" deep (2.5 x 7.6cm)

**200-173** Blade ¾" x 2" deep (1.9 x 5.1cm)



**HARRINGTON** Splanchnic Retractors,  
Lamb handle, 12½" (31.8cm)

**200-175** Blade 1½" wide (3.8cm)

**200-176** Blade 2½" wide (6.4cm)

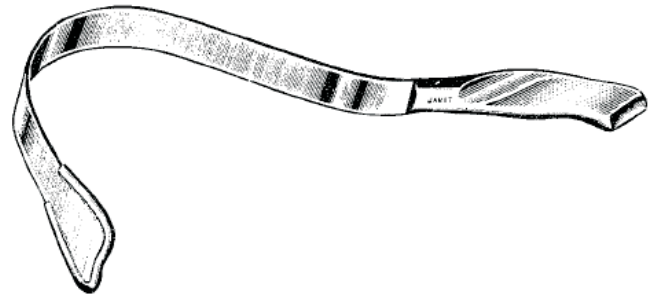

**200-178** **HARRINGTON-PEMBERTON** Retractor,  
12" (30.5cm), blade 2½" wide (6.4cm)

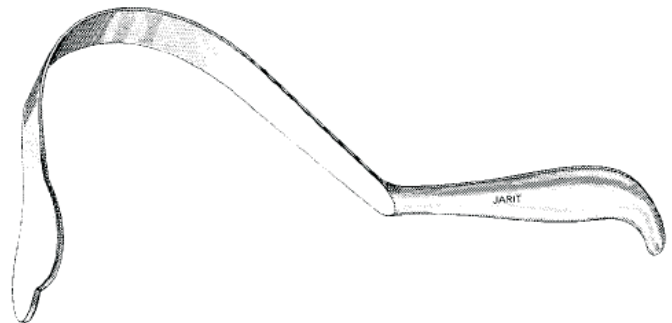



**FORD-DEAVER** Retractors,  
Lamb handle, 16½" (41.9cm),  
blade 10" long x 6" deep,  
(25.4cm x 15.2cm)

- 200-180 2" wide (5.1cm)
- 200-181 3" wide (7.6cm)
- 200-182 4" wide (10.2cm)

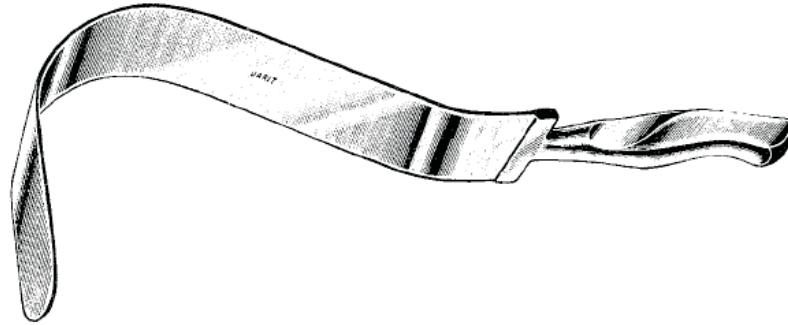

**MEYERDING** Retractors

- 200-190 8" (20.3cm), blade ⅝" x 2" deep (1.6 x 5.1cm)
- 200-191 9" (22.9cm), blade 1" x 3" deep (2.5 x 7.6cm)
- 200-192 9½" (24.1cm), blade 2" x 3½" deep (5.1 x 8.9cm)

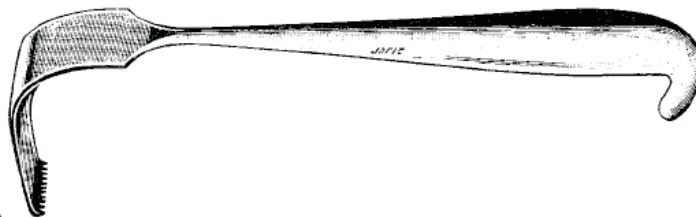

**JARIT-DEAVER** Retractors,  
6¾" (17.1cm), double-ended,  
pediatric sizes

- 200-194 Blade 8mm wide
- 200-195 Blade 10mm wide
- 200-196 Blade 12mm wide

- 200-197 **JARIT-DEAVER** Retractors,  
Set of 3

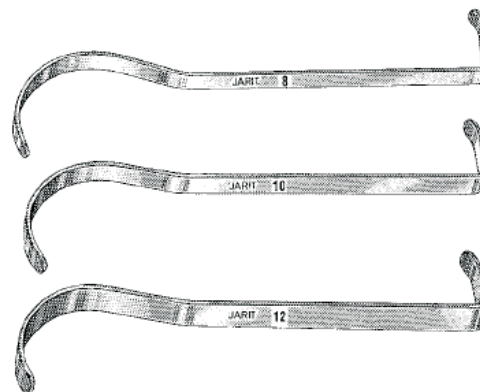

**200-198** DEAVER Retractor,  
3/8" wide x 7" long (1 x 17.8cm), pediatric size



**200-200** DEAVER Retractor,  
3/4" wide x 7" long (1.9 x 17.8cm)



**200-201** DEAVER Retractor,  
7/8" wide x 8 1/2" long (2.2 x 21.6cm)



**DEAVER Retractors**  
**200-202** 1" wide x 12" long (2.5 x 30.5cm)  
**200-203** 1" wide x 13" long (2.5 x 33cm)  
**200-204** 1" wide x 14" long (2.5 x 35.6cm)

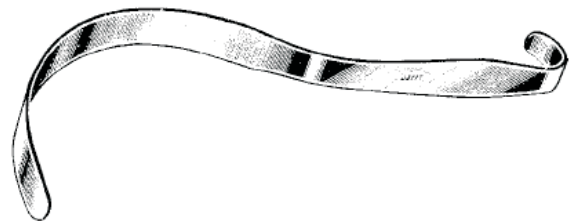

**JARIT** HAND RETRACTORS

**DEAVER Retractors**

- 200-205 1½" wide x 12" long (3.8 x 30.5cm)
- 200-206 2" wide x 12" long (5.1 x 30.5cm)

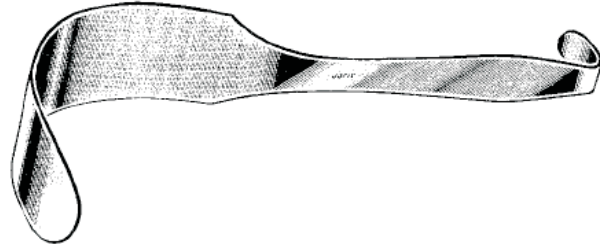

**DEAVER Retractors**

- 200-207 3" wide x 12" long (7.6 x 30.5cm)
- 200-208 1" wide x 10½" long (2.5 x 26.7cm)

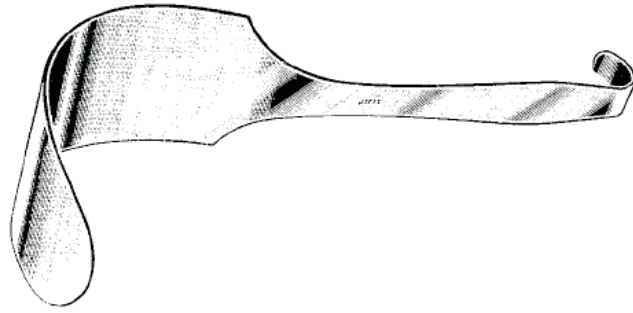

- 200-210 **DEAVER Retractor,**  
1" wide x 9" long (2.5 x 22.9cm)

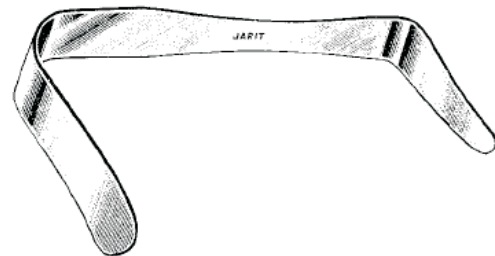

**DEAVER Retractors,**  
hollow grip handle

- 201-200 1" wide x 10" long (2.5 x 25.4cm)
- 201-201 1" wide x 12" long (2.5 x 30.5cm)
- 201-202 1" wide x 13" long (2.5 x 33cm)
- 201-203 2½" wide x 14½" long (6.4 x 36.8cm)
- 201-204 3½" wide x 12" long (8.9 x 30.5cm)
- 201-205 2" wide x 12" long (5.1 x 30.5cm)
- 201-206 3" wide x 12" long (7.6 x 30.5cm)

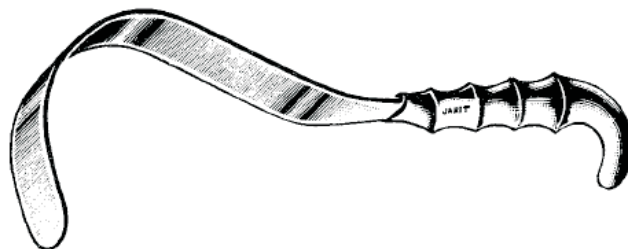

**JARIL** HAND RETRACTORS

- 200-116 CHILDREN'S HOSPITAL Retractor,**  
double ended, 5½" (14cm)  
Large blade: 7⁄8" wide x 1⁄8" deep (11cm and 22cm)  
Small blade: 9⁄16" wide x 1 3⁄8" deep (14cm x 35cm)



**RIBBON Retractors,**  
malleable blade, pediatric sizes

- 200-217** 1" wide x 10" long (2.5 x 25.4cm)  
**200-218** 5⁄8" wide x 6 3⁄4" long (1.6 x 17.1cm)  
**200-219** 1" wide x 7 1⁄2" long (2.5 x 19.1cm)

**RIBBON Retractors,**  
malleable blade, 13" (33cm)

- 200-220** 3⁄4" wide (1.9cm)  
**200-221** 1" wide (2.5cm)  
**200-222** 1 1⁄4" wide (3.2cm)  
**200-223** 1 1⁄2" wide (3.8cm)  
**200-225** 2" wide (5.1cm)  
**200-226** 2 1⁄2" wide (6.5cm)  
**200-227** 3" wide (7.6cm)  
**200-228** 4" wide (10.2cm)

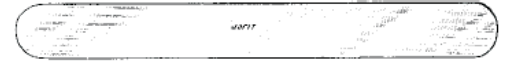

**RIBBON Retractors,**  
hollow grip handle,  
malleable blade 13" (33cm),  
overall length 18" (45.7cm)

- 201-220** 3⁄4" wide (1.9cm)  
**201-221** 1" wide (2.5cm)  
**201-222** 1 1⁄4" wide (3.2cm)  
**201-223** 1 1⁄2" wide (3.8cm)  
**201-225** 2" wide (5.1cm)



**WILLAUER-DEAVER Retractors,**  
15 1⁄2" (39.4cm), blade 6 1⁄4" deep (15.9cm)

- 200-235** 1" wide (2.5cm)  
**200-237** 2" wide (5cm)



- 200-255 WEINBERG Vagotomy Retractor,**  
9 1⁄2" (24.1cm)  
Large blade: 3 5⁄8" wide x 6" deep (9.2cm and 15.2cm)  
Small blade: 1 1⁄2" wide x 2 1⁄4" deep (4.8cm x 5.7cm)

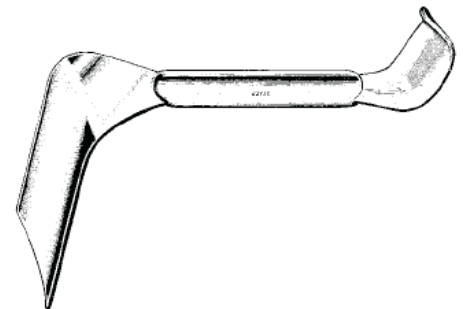

**VOLKMAN** Retractors,  
8" (20.3cm), sharp

Satin Matte

<b>200-270</b>		2 prongs, 9mm x 8mm wide
<b>200-271</b>		3 prongs, 9mm x 13mm wide
<b>200-272</b>	<b>199-272</b>	4 prongs, 9mm x 18mm wide
<b>200-273</b>		6 prongs, 9mm x 28mm wide

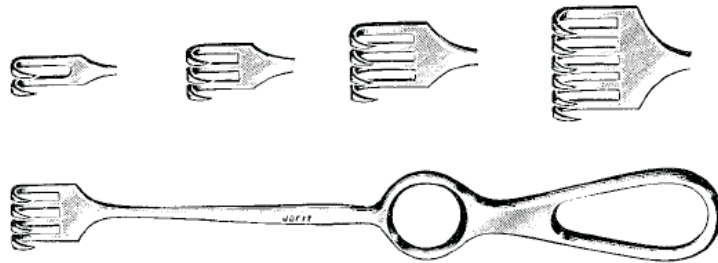

**VOLKMAN** Retractors,  
8" (20.3cm), blunt

Satin Matte

<b>200-280</b>		2 prongs, 9mm x 8mm wide
<b>200-281</b>		3 prongs, 9mm x 13mm wide
<b>200-282</b>	<b>199-282</b>	4 prongs, 9mm x 18mm wide
<b>200-283</b>		6 prongs, 9mm x 28mm wide

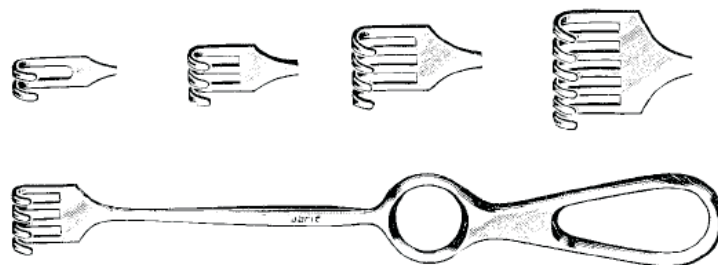

**VOLKMAN Retractors,**  
8 3/4" (22.2cm), USA Pattern, sharp

Satin Matte

<b>200-290</b>		2 prongs, 16mm x 11mm wide
<b>200-291</b>		3 prongs, 16mm x 18mm wide
<b>200-292</b>	<b>199-292</b>	4 prongs, 16mm x 26mm wide
<b>200-293</b>		6 prongs, 16mm x 40mm wide

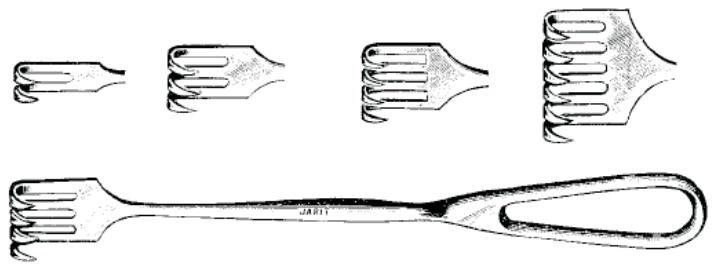

**VOLKMAN Retractors,**  
8 3/4" (22.2cm), USA Pattern, blunt

Satin Matte

<b>200-295</b>		2 prongs, 16mm x 11mm wide
<b>200-296</b>		3 prongs, 16mm x 18mm wide
<b>200-297</b>	<b>199-297</b>	4 prongs, 16mm x 26mm wide
<b>200-298</b>		6 prongs, 16mm x 40mm wide

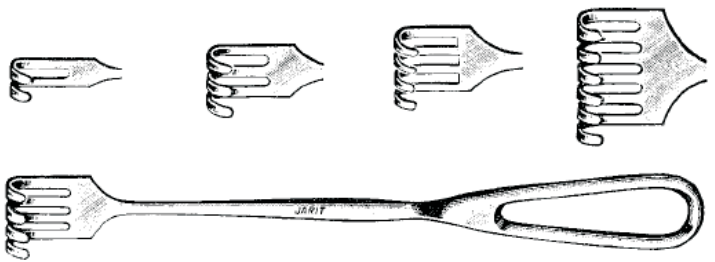

**Jarvis** RAKE RETRACTORS

**MURPHY** Retractors,  
7 $\frac{1}{8}$ " (19.4cm), sharp

- 200-300** 2 prongs, 8mm x 8mm wide
- 200-301** 3 prongs, 8mm x 13mm wide
- 200-302** 4 prongs, 8mm x 18mm wide
- 200-303** 6 prongs, 8mm x 28mm wide

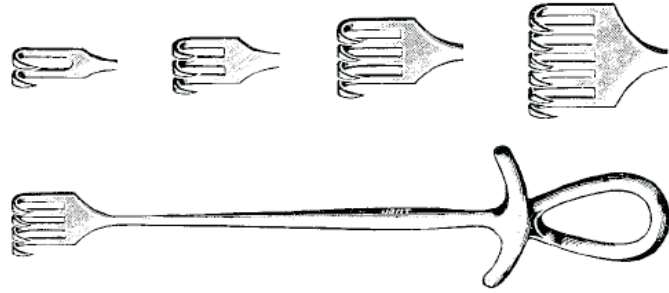

**MURPHY** Retractors,  
7 $\frac{1}{8}$ " (19.4cm), blunt

- 200-310** 2 prongs, 8mm x 8mm wide
- 200-311** 3 prongs, 8mm x 13mm wide
- 200-312** 4 prongs, 8mm x 18mm wide
- 200-313** 6 prongs, 8mm x 28mm wide

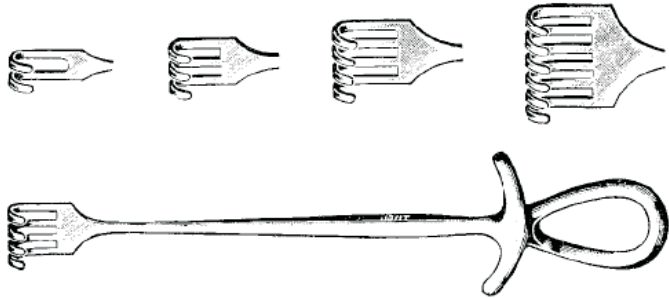

- 200-315** **ISRAEL** Retractor,  
7 $\frac{1}{2}$ " (19.1cm), blunt, 4 prongs,  
40mm x 42mm wide

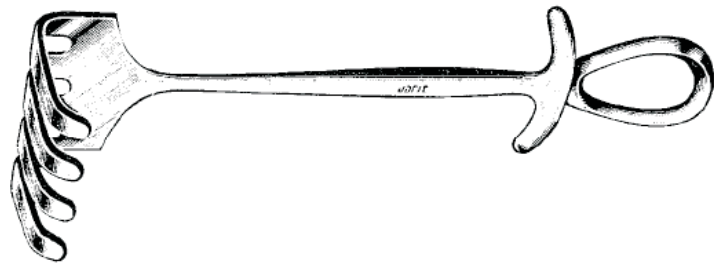

- 200-318** **OLLIER** Retractor,  
9" (22.9cm), blunt, 4 prongs,  
34mm x 56mm wide

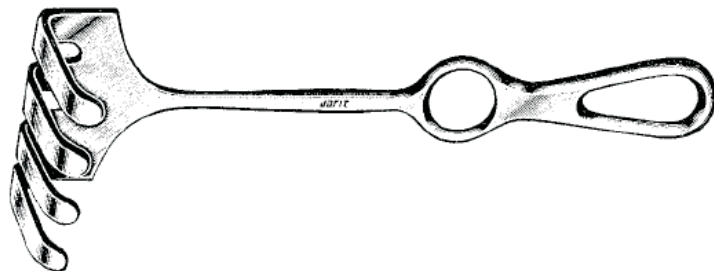

**JARIT** SELF-RETAINING RETRACTORS

205-100 **ALM Retractor**,  
2¾" (7cm), 2" (5cm) spread

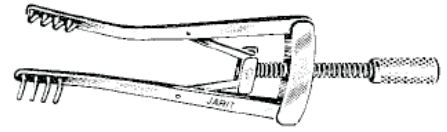

205-105 **ALM Retractor**,  
4" (10.2cm), 2½" (6.4cm) spread

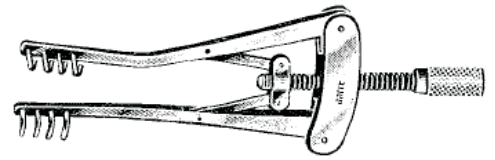

**JARIT Cross Action Retractors**,  
4" (10.2cm), 1" (2.5cm) spread

205-110 Sharp prongs  
205-111 Blunt prongs

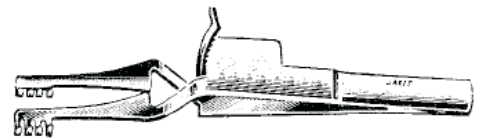

**GELPI Perineal Retractor**,  
7½" (19.1cm)

Satin Matte  
205-120 204-120 7½" (19.1cm)

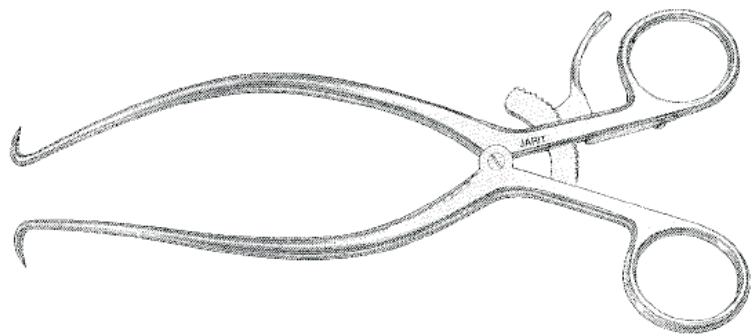



**JARIT** SELF-RETAINING RETRACTORS

205-121 **GELPI** Perineal Retractor,  
7½" (19.1cm), with ball stops

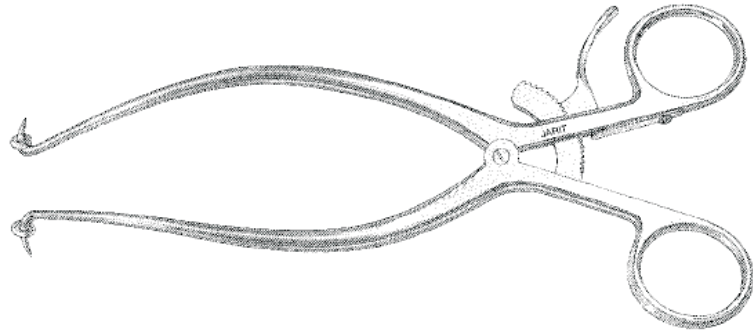

**GELPI** Perineal Retractors,  
pediatric sizes

Satin	Matte	
205-123	204-123	3½" (8.9cm)
205-124	204-124	4½" (11.4cm)
205-125	204-125	5½" (14cm)

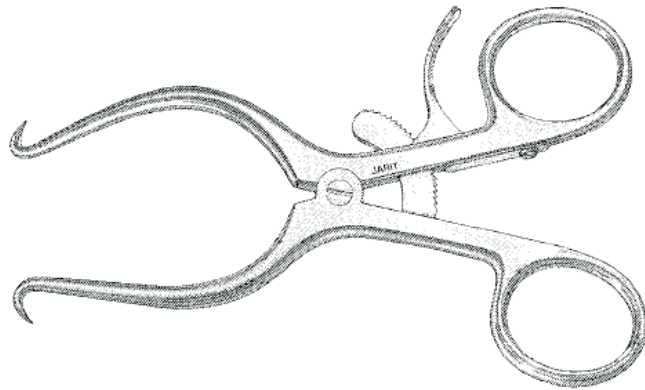

**FARR** Spring Retractors

205-130	1½" (3.8cm) sharp points
205-131	2" (5cm) sharp points
205-132	2¼" (5.8cm) sharp points
205-133	2½" (6.4cm) sharp points
205-134	3" (7.5cm) sharp points
205-135	2½" (6.4cm) flat blades

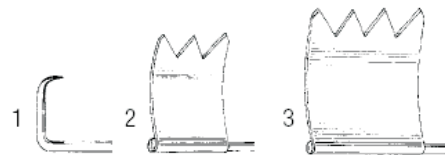

**JARIT** Spring Wire Retractors

205-136	3" (7.5cm), style 1
205-137	3½" (9cm), style 2
205-138	4½" (11.5cm), style 3

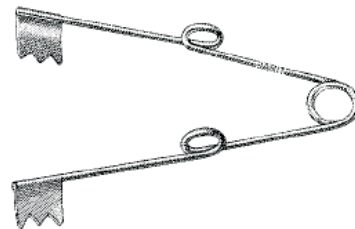



## SELF-RETAINING RETRACTORS

### WEITLANER Retractors

Satin

Matte

205-140	204-140	4½" (11.4cm), 2 x 3 sharp prongs, 15mm deep
205-141	204-141	4½" (11.4cm), 2 x 3 blunt prongs, 15mm deep
205-150	204-150	5½" (14cm), 3 x 4 sharp prongs, 17mm deep
205-151	204-151	5½" (14cm), 3 x 4 blunt prongs, 17mm deep
205-155	204-155	6½" (16.5cm), 3 x 4 sharp prongs, 18mm deep
205-156	204-156	6½" (16.5cm), 3 x 4 blunt prongs, 18mm deep
205-160	204-160	8" (20.3cm), 3 x 4 sharp prongs, 20mm deep
205-161	204-161	8" (20.3cm), 3 x 4 blunt prongs, 20mm deep
205-165	204-165	9½" (24.1cm), 3 x 4 sharp prongs, 27mm deep
205-166	204-166	9½" (24.1cm), 3 x 4 blunt prongs, 27mm deep

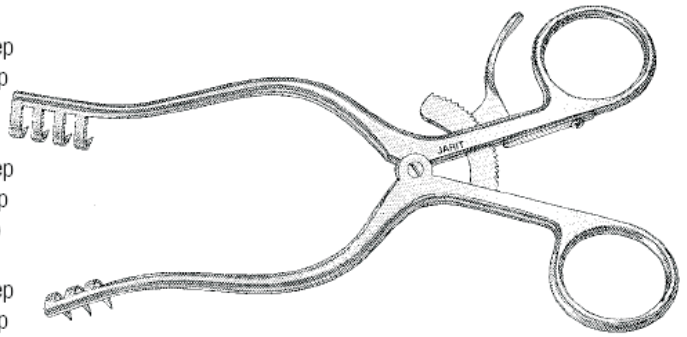

### WEITLANER Retractors, hinged blades

205-175	5½" (14cm), 3 x 4 sharp prongs, 18mm deep
205-176	5½" (14cm), 3 x 4 blunt prongs, 18mm deep
205-180	6¼" (15.9cm), 3 x 4 sharp prongs, 18mm deep
205-181	6¼" (15.9cm), 3 x 4 blunt prongs, 18mm deep
205-190	8" (20.3cm), 3 x 4 sharp prongs, 20mm deep

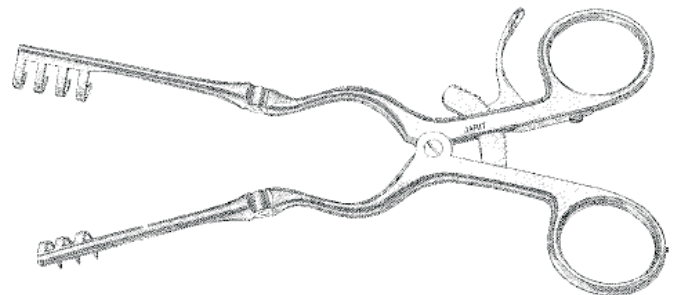

### ADSON Cerebellar Retractors, 7½" (19.1cm)

205-200	4 x 4 sharp prongs, 22mm deep
205-201	4 x 4 blunt prongs, 22mm deep

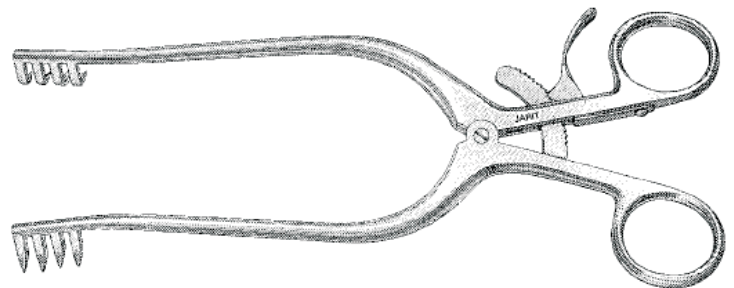

**JART** SELF-RETAINING RETRACTORS

205-205 **ADSON** Cerebellar Retractor,  
7¼" (18.4cm), angular, 4 x 4 sharp prongs,  
22mm deep

205-206 **ADSON** Cerebellar Retractor (angled shanks),  
7¼" (18.4cm), angular, 4 x 4 blunt prongs,  
22mm deep

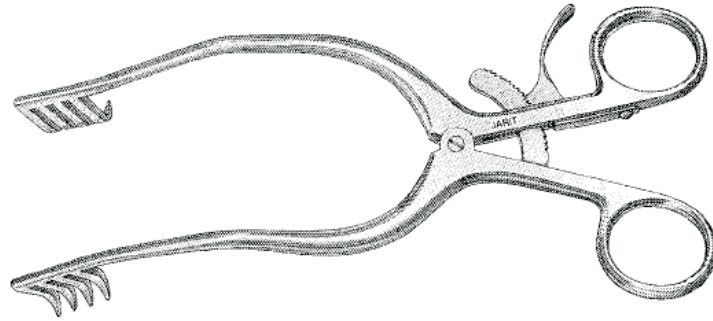

**BECKMAN** Thyroid Retractors

205-209 9½" (24.1cm), 3 x 4 sharp prongs,  
1½" deep (2.8cm)

205-210 12¾" (31.4cm), 4 x 4 sharp prongs,  
⅝" deep (1.6cm)

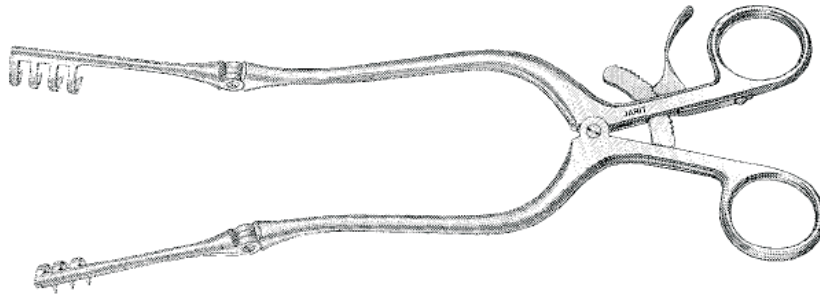

**BECKMAN-ADSON** Retractors,  
12" (30.5cm)

205-220 4 x 4 sharp prongs,  
1" x 1" deep (2.5 x 2.5cm)

205-221 4 x 4 blunt prongs,  
1" x 1" deep (2.5 x 2.5cm)

205-225 4 x 4 sharp prongs,  
1" x 1½" deep (2.5 x 4.4cm)

205-226 4 x 4 blunt prongs,  
1" x 1½" deep (2.5 x 4.4cm)

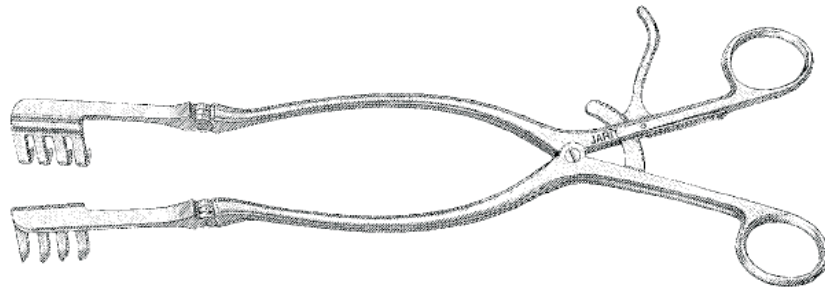

205-230 **BECKMAN-EATON** Retractor,  
12½" (31.8cm), 7 x 7 sharp prongs,  
1¾" x 1½" deep (4.4 x 4.8cm)

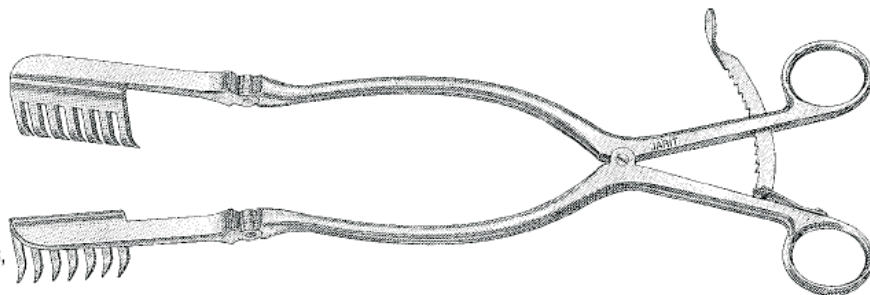

205-235 **MAYO-ADAMS** Retractor,  
6 $\frac{3}{4}$ " (17.1cm), removable center blade

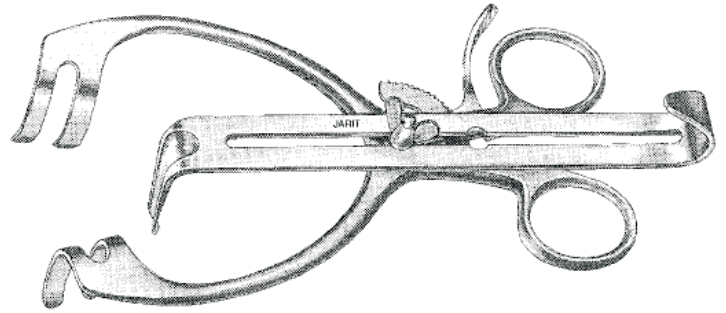

205-237 **RIGBY** Retractor,  
7 $\frac{1}{2}$ " (19.1cm), blades  $1\frac{1}{8}$ " x 2 $\frac{1}{2}$ " deep (2.1cm x 6.4cm)

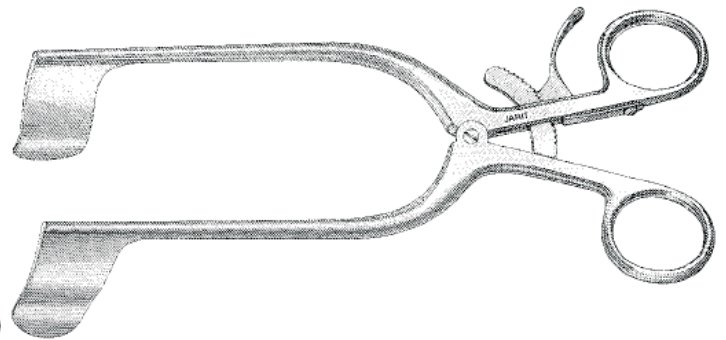

**MEYERDING** Laminectomy Retractors,  
7 $\frac{1}{2}$ " (19.1cm)

- 205-240 Blades 1" x 1 $\frac{1}{4}$ " deep (2.5 x 3.2cm)
- 205-242 Blades 1" x 2 $\frac{1}{8}$ " deep (2.5 x 5.4cm)
- 205-244 Blades  $\frac{3}{4}$ " x 2 $\frac{3}{8}$ " deep (1.9 x 6cm)
- 205-245 Blades 1" x 2 $\frac{3}{8}$ " deep (2.5 x 6cm)

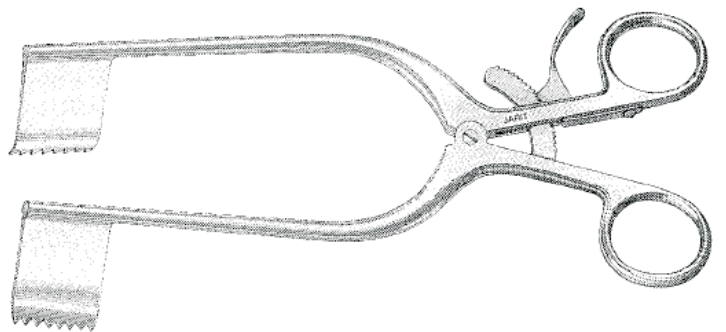

205-251 **GOSSET** Retractor,  
5½" (14cm) spread, blades 1" x 2½" deep (2.5 x 6.4cm)

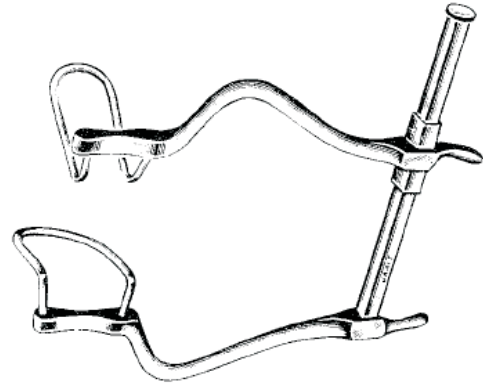

205-255 **MARKHAM-MEYERDING** Hemilaminectomy Retractor,  
6¾" (17.1cm), blade 1" x 2½" deep (2.5 x 6.4cm),  
blade on right side

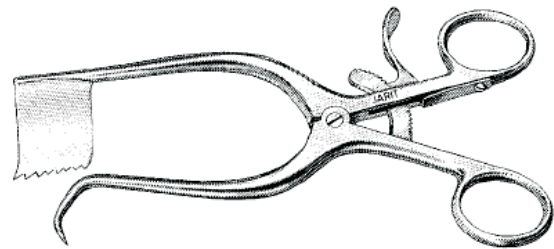

205-256 **MARKHAM-MEYERDING** Hemilaminectomy Retractor,  
6¾" (17.1cm), blade 1" x 2½" deep (2.5 x 6.4cm),  
blade on left side

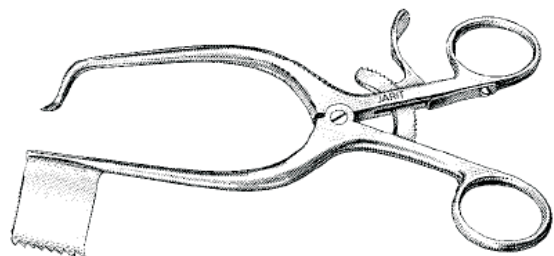

**BALFOUR** Abdominal Retractors,  
with wire lateral blades 2" (5.1cm) deep  
and center blade 3" wide x 2" deep (7.6cm x 5.1cm)

- 205-270 7" (17.8cm) spread
- 205-275 10" (25.4cm) spread

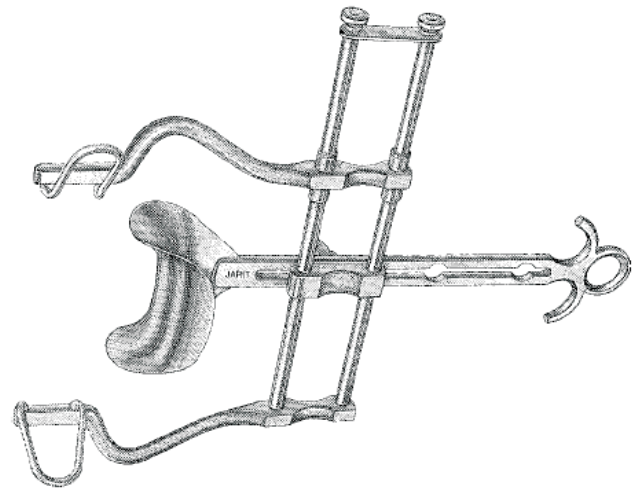

- 205-280 **BALFOUR** Abdominal Retractor  
7" (17.8cm) spread,  
with solid lateral blades 2" (5.1cm) deep and  
center blade 3" wide x 2" deep (7.6cm x 5.1cm)

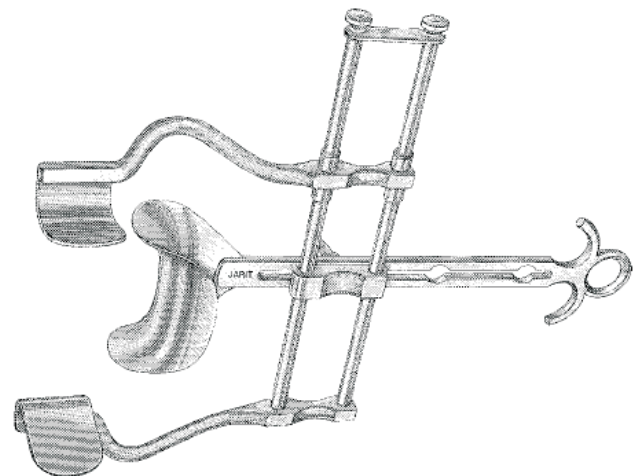



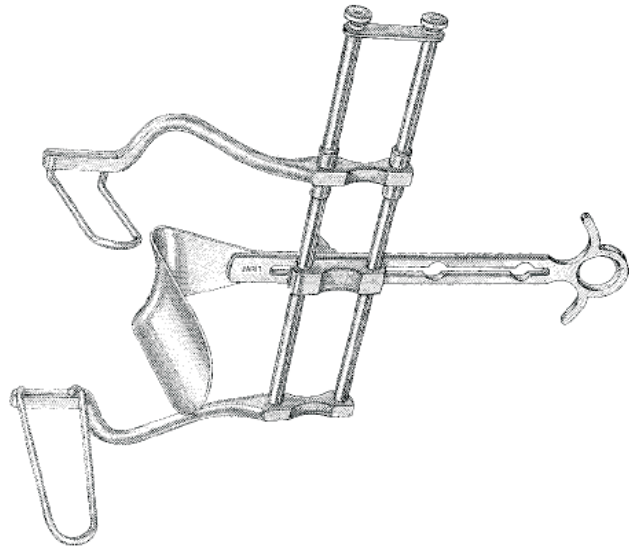

**BALFOUR** Abdominal Retractors,  
with wire lateral blades 4" (10.1cm) deep  
and center blade 2½" wide x 4" deep (6.4cm x 10.1cm)

- 205-290 7" (17.8cm) spread
- 205-291 10" (25.4cm) spread

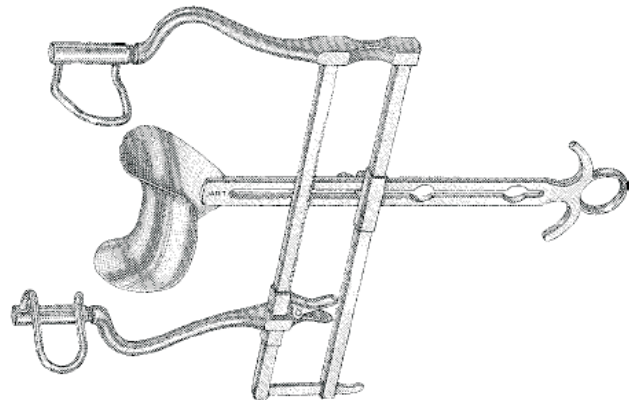

**BALFOUR** Abdominal Retractors with Ratchet Bar

- 205-295 7" (17.8cm) spread.  
Set includes a pair of 2" (5.1cm) and 3" (7.6cm) deep  
interchangeable wire lateral blades; also one center blade  
2½" wide x 1½" deep (6.7cm x 3.8cm) and one center blade  
3¼" wide x 2¾" deep (8.3cm x 7cm)
- 205-296 10" (25.4cm) spread.  
Set includes a pair of 2" (5.1cm) and 4" (10.1cm) deep  
interchangeable wire lateral blades; also one center blade  
3" wide x 2" deep (7.6cm x 5.1cm) and one center blade  
2½" wide x 4" deep (6.4cm x 10.1cm)

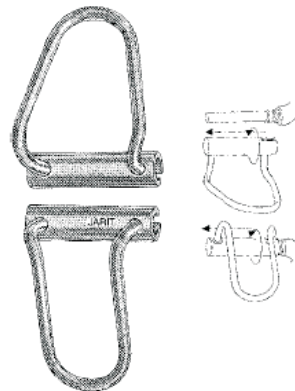

**BALFOUR** Wire Lateral Blades  
for 205-295 and 205-296

- 205-335 2" (5.1cm) deep
- 205-336 3" (7.6cm) deep
- 205-337 4" (10.2cm) deep

**JARIT** SELF-RETAINING RETRACTORS

**205-292** **BALFOUR** Center Blade  
Standard,  
2½" wide x 1½" deep (6.7cm x 3.8cm)

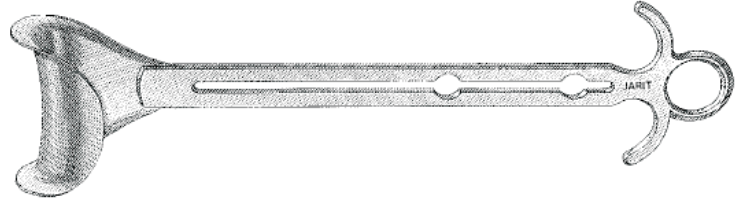

**205-293** **BALFOUR** Center Blade  
Supra-Pubic,  
3¼" wide x 2¾" deep (8.2cm x 6.9cm)

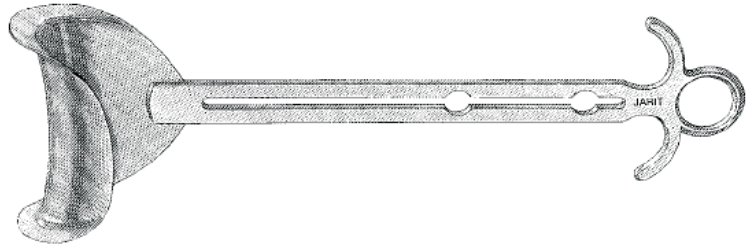

**205-294** **BALFOUR** Center Blade  
HORGAN, malleable,  
2" wide x 5" deep (5.1cm x 12.6cm)

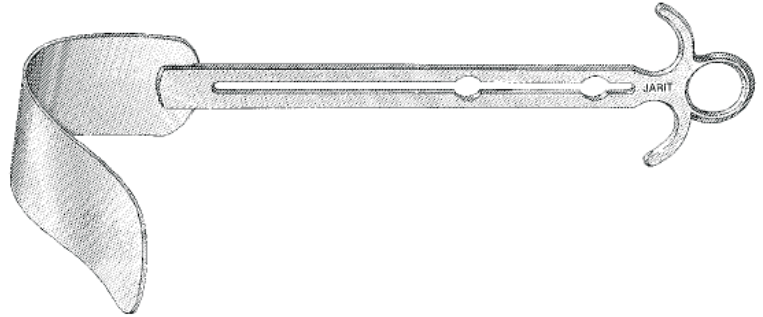

**205-298** **BALFOUR** Center Blade  
Standard,  
3" wide x 2" deep (7.6cm x 5.1cm)

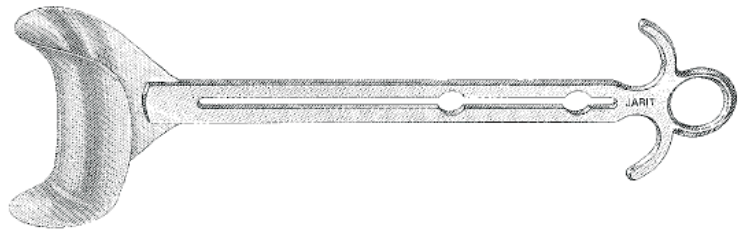

**205-299** **BALFOUR** Center Blade  
Extra deep,  
2½" wide x 4" deep (6.4cm x 10.1cm)

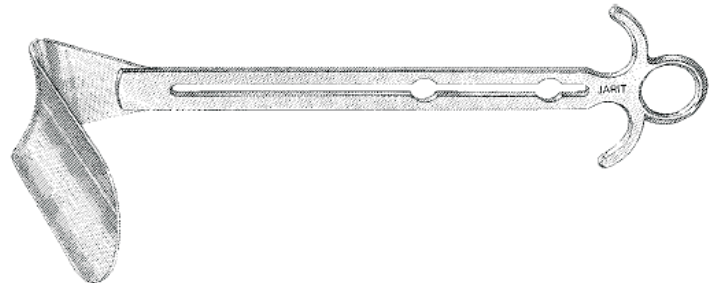



**205-300** **BALFOUR** Abdominal Retractors with Ratchet Bar  
7" (17.8cm) spread,  
with 2" (5.1cm) deep wire lateral blades and  
center blade 3" wide x 2" deep (7.6cm x 5.1cm)

**205-305** 7" (17.8cm) spread,  
with 4" (10.1cm) deep wire lateral blades and  
center blade 2½" wide x 4" deep (6.4cm x 10.1cm)

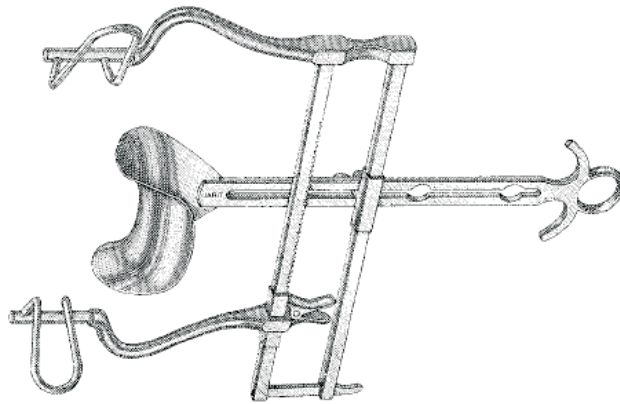

**205-310** **BALFOUR** Abdominal Retractor,  
3½" (8.9cm) spread, pediatric size,  
with 1½" (3.5cm) deep wire lateral blades and  
center blade ¾" wide x ¾" deep (2.2cm x 2.2cm)

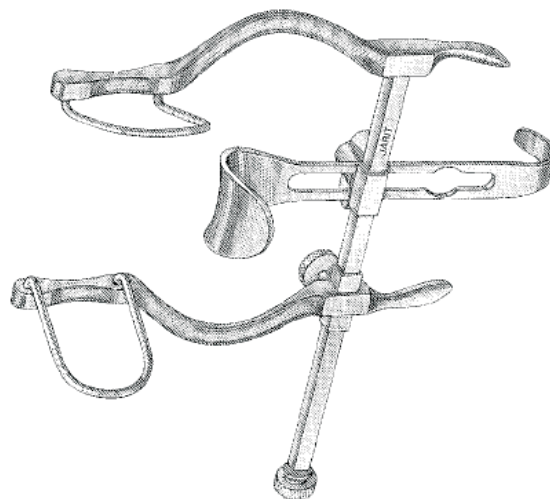

**BALFOUR** Abdominal Retractors with Ratchet Bar Positioning Mechanism

- 205-315** 7 $\frac{3}{4}$ " (19.7cm) spread.  
Set includes a pair of 2 $\frac{1}{2}$ " (6.4cm) and 3 $\frac{1}{2}$ " (8.8cm) deep interchangeable wire lateral blades and one center blade 2 $\frac{5}{8}$ " wide x 1 $\frac{1}{2}$ " deep (6.7cm x 4.1cm). Snap-on lateral blades can be attached and removed in seconds.
  
- 205-316** 10 $\frac{1}{2}$ " (26.7cm) spread.  
Set includes a pair of 2 $\frac{1}{2}$ " (6.4cm) and 3 $\frac{1}{2}$ " (8.8cm) deep interchangeable wire lateral blades and one center blade 2 $\frac{5}{8}$ " wide x 2 $\frac{3}{4}$ " deep (6.7cm x 6.9cm). Snap-on lateral blades can be attached and removed in seconds.

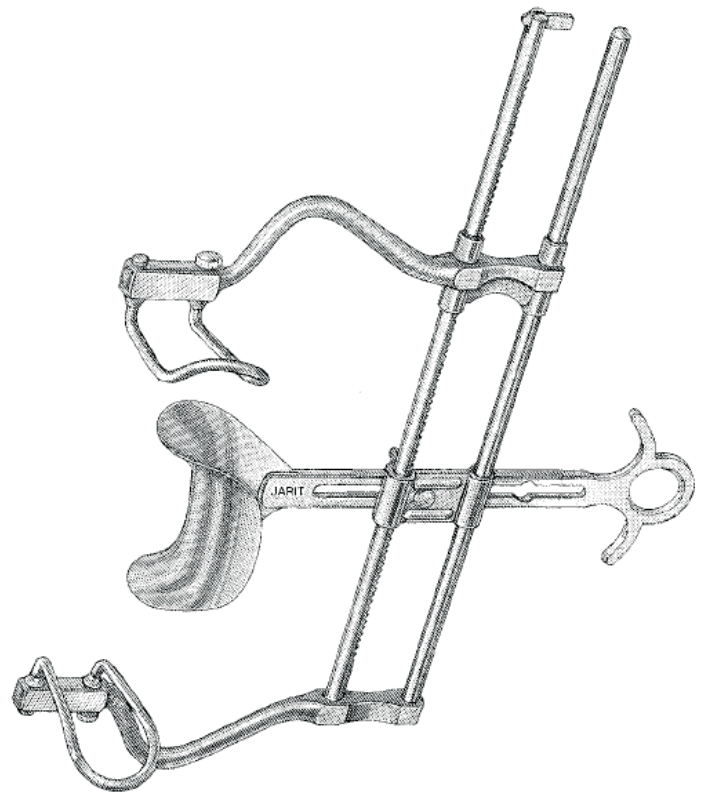

**BALFOUR** Wire Lateral Blades for 205-315 and 205-316

- 205-330** 2 $\frac{1}{2}$ " (6.4cm) deep
- 205-331** 3 $\frac{1}{2}$ " (8.8cm) deep
- 205-332** 4" (10.1cm) deep

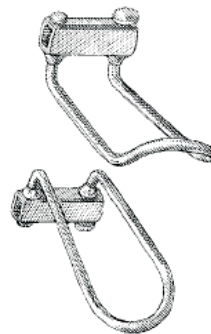

**JAHIT** SELF-RETAINING RETRACTORS

**205-320** **BALFOUR** Center Blade for  
205-315 and 205-316  
Standard,  
2<sup>5</sup>/<sub>8</sub>" wide x 1<sup>1</sup>/<sub>4</sub>" deep (6.7cm x 4.1cm)

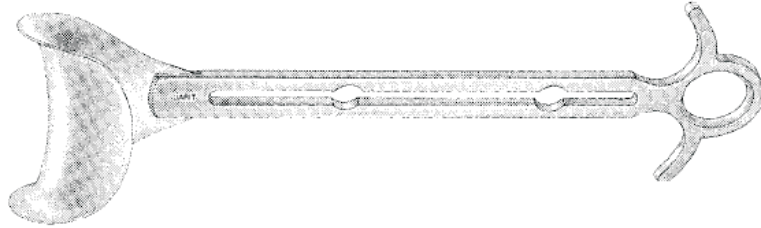

**205-321** **BALFOUR** Center Blade for  
205-315 and 205-316  
Standard,  
3<sup>5</sup>/<sub>8</sub>" wide x 1<sup>1</sup>/<sub>4</sub>" deep (9.2cm x 4.4cm)

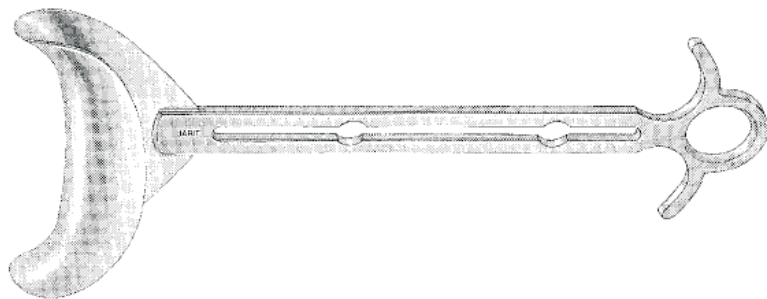

**205-322** **BALFOUR** Center Blade for  
205-315 and 205-316  
Supra-Pubic,  
2<sup>5</sup>/<sub>8</sub>" wide x 2<sup>3</sup>/<sub>4</sub>" deep (6.7cm x 6.9cm)

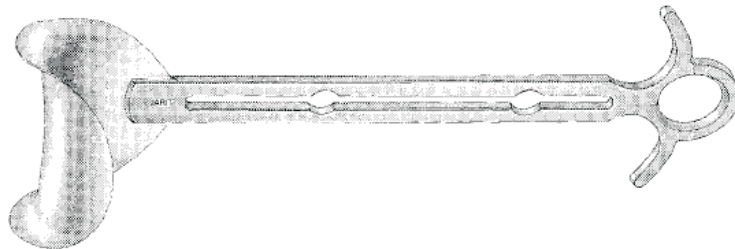

**205-323** **BALFOUR** Center Blade for  
205-315 and 205-316  
Supra-Pubic,  
3<sup>1</sup>/<sub>4</sub>" wide x 2<sup>3</sup>/<sub>4</sub>" deep (8.2cm x 6.9cm)

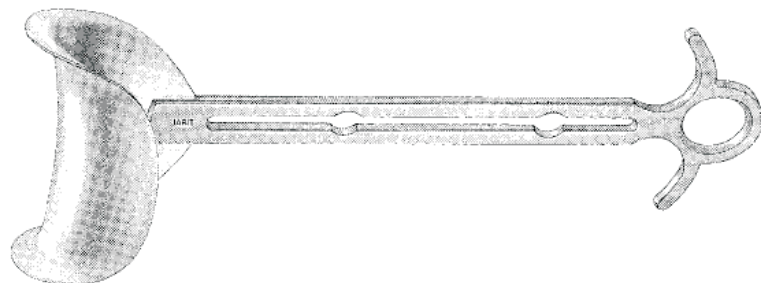

**205-324** **BALFOUR** Center Blade for  
205-315 and 205-316  
HORGAN, malleable,  
2" wide x 7<sup>3</sup>/<sub>4</sub>" deep (5.1cm x 19.7cm)

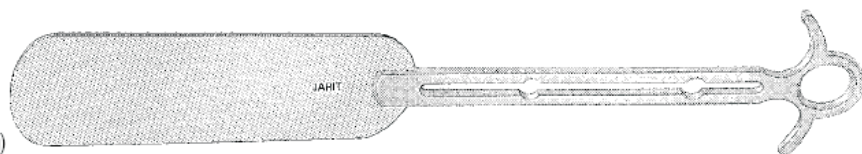

**JART** SELF-RETAINING RETRACTORS

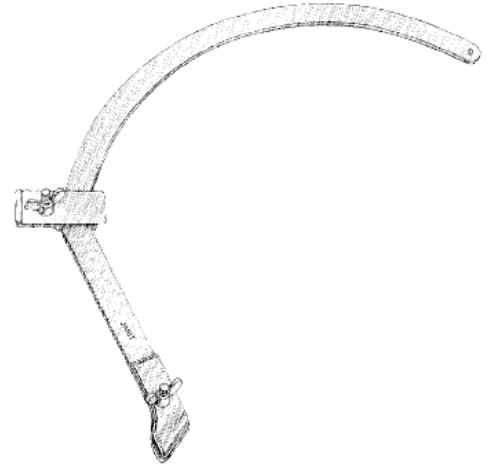

**BALFOUR** Fourth Blade Attachments,  
for 205-315 and 205-316 (center blade not included)

- 205-312 For right arm
- 205-313 For left arm (illustrated)

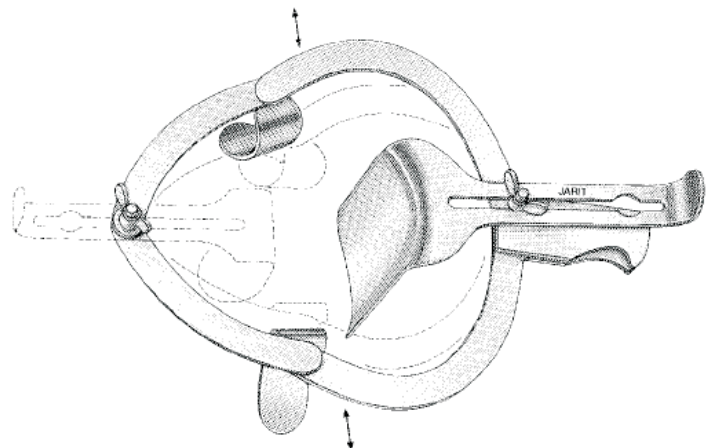
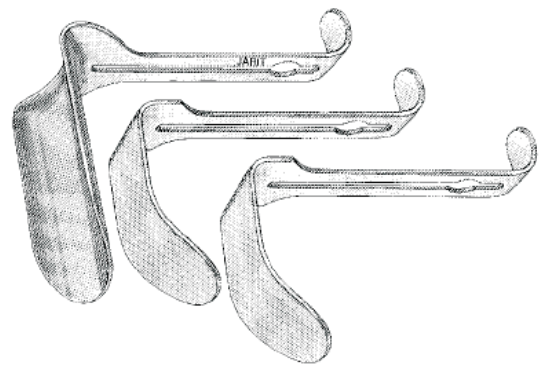

205-325 **O'SULLIVAN-O'CONNOR** Abdominal Retractor,  
with 3 removable and 2 fixed blades

Removable blades:  
1 $\frac{3}{4}$ " x 3" deep (4.4cm x 7.6cm)  
1 $\frac{3}{4}$ " x 3" deep (4.4cm x 7.6cm)  
2 $\frac{3}{4}$ " x 4 $\frac{1}{4}$ " deep (7cm x 10.8cm)

Fixed blades:  
1" x 2 $\frac{3}{8}$ " deep (2.5cm x 6.7cm)

# SETON SHALLOW

The patented Seton\* Shallow Surgical Retractor is a four-sided, stainless steel surgical retractor developed to aid the surgeon during shallow or superficial surgery, such as hernias (groin, ventral, and incisional), femoral-popliteal bypass surgery, urological surgical procedures,

varicose vein surgery, certain orthopedic procedures, soft tissue excisions, biopsies or thyroid surgery. The combination of different retractor blades, toothed or cupped, can be used to accommodate various body builds, wound depths and types of procedures.

- A steady, non-slipping operative field.
- A complete, obstruction-free surgical window.
- A reduction of extraneous motion, fatigue and constant repositioning.
- An operative window that can be incrementally increased or decreased.
- The ability to perform an unassisted surgical procedure.

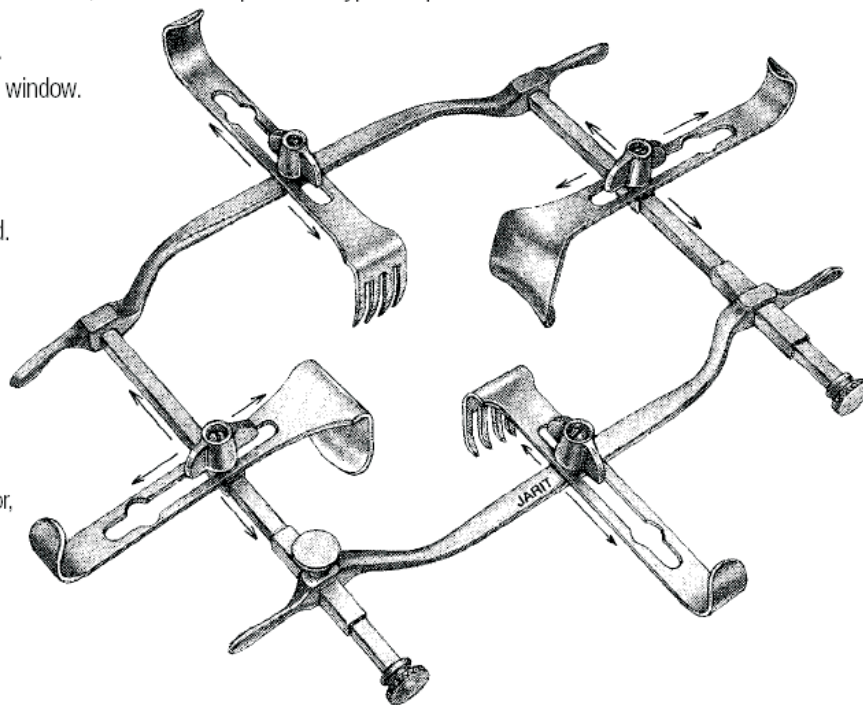

**205-500** SETON Shallow Surgical Retractor, complete

**205-502** SETON Retractor Frame

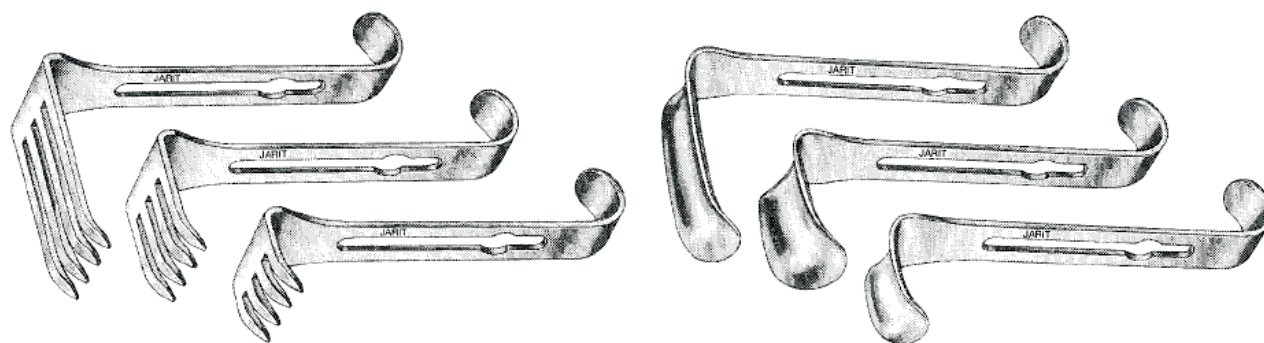

**205-504** SETON Retractor Blades  
4 prong semi-sharp, set of two,  
1" x 2" deep (2.5cm x 5.1cm)

**205-506** 4 prong semi-sharp, set of two,  
1" x 1 1/2" deep (2.5cm x 2.9cm)

**205-508** 4 prong semi-sharp, set of two,  
1" x 1 1/8" deep (2.5cm x 1.9cm)

**205-510** BALFOUR-type, set of two,  
1 3/8" x 2" deep (2.1cm x 5.1cm)

**205-512** BALFOUR-type, set of two,  
1 1/8" x 1 1/4" deep (2.7cm x 3.2cm)

**205-514** BALFOUR-type, set of two,  
1 3/8" x 1" deep (2.1cm x 2.5cm)